



Product Model Number

CKO-CC20-075026-0401

✓ Model Number Definitions

CKO-XXXX-XXXXXX-XXXX



- A. Chun Kuang Optics Corp. Product
- B. Product Type: product abbreviation
Ex:
CH→CoB High Intensity
CC→CoB Compact
CS→Soft Shading for CoB LED
HC→Holder for CoB LED

- C. Identity Code
- D. Lens / Fixture Size
Ex: 075026=Φ75mm / Thickness=26mm (round up)
- E. Serial Numbers

The lens datasheet is applicable for **Citizen LED**, that manufactured by Chun Kuang Optics Corp.

✓ Dimensions (mm) : Φ75 x 25.4

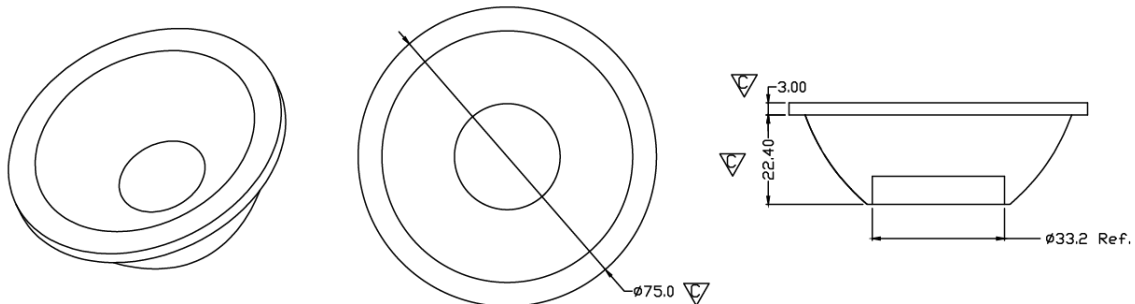

▽:Critical Dimension



Optical Characteristics

| | | | |
|-------------------|---------------------------|-------------------|-----------------------|
| Model Number | CKO-CC20-075026-0401 | | <p>"H" definition</p> |
| LED | CLU 710 | | |
| LES / LED Size | Φ 8.5 mm | | |
| FWHM (D50) | 11° | | |
| Field Angle (D10) | 26° | | |
| H (distance) | 3.65mm | | |
| Dimension | Φ =75 mm, Thickness=33 mm | | |
| Luminous Flux | 2514 lm | Measured @ 25.9 W | |
| Material | PC / UL94V2 | | |

cd/klm

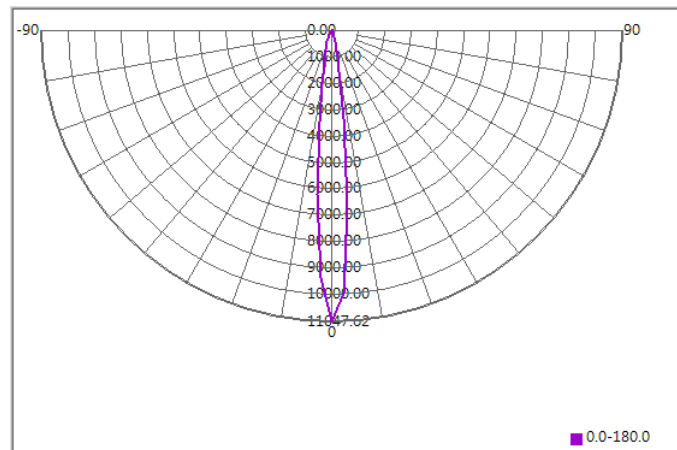

Illuminance At Distances

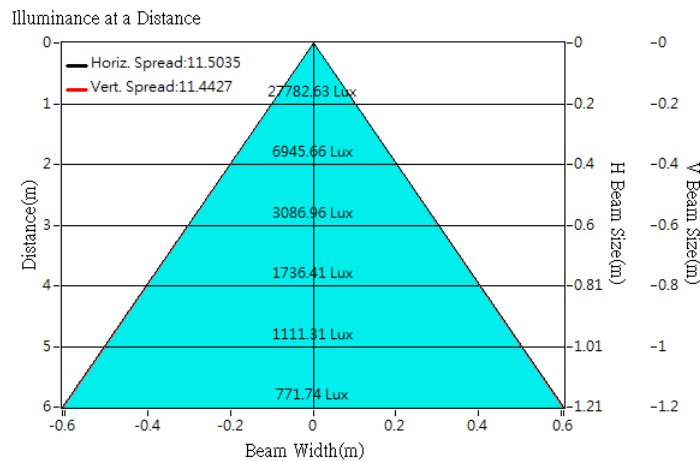



Optical Characteristics

| | | | |
|-------------------|---------------------------|-------------------|-----------------------|
| Model Number | CKO-CC20-075026-0401 | | <p>"H" definition</p> |
| LED | CLU 711 | | |
| LES / LED Size | Φ 8.5 mm | | |
| FWHM (D50) | 11° | | |
| Field Angle (D10) | 25° | | |
| H (distance) | 3.65mm | | |
| Dimension | Φ =75 mm, Thickness=33 mm | | |
| Luminous Flux | 2840 lm | Measured @ 25.3 W | |
| Material | PC / UL94V2 | | |

cd/klm

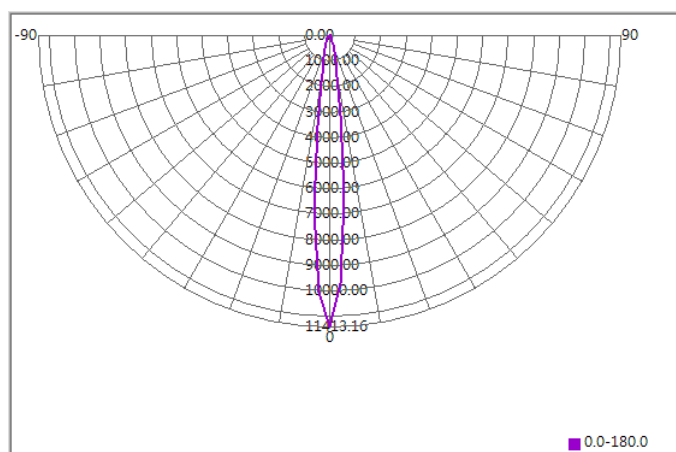

Illuminance At Distances

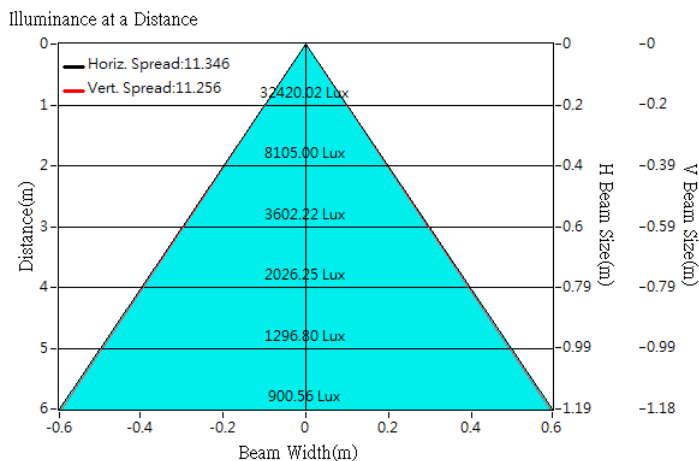



Optical Characteristics

| | | | |
|-------------------|---------------------------|-------------------|-----------------------|
| Model Number | CKO-CC20-075026-0401 | | <p>"H" definition</p> |
| LED | CLU 028 | | |
| LES / LED Size | Φ 9.8 mm | | |
| FWHM (D50) | 12° | | |
| Field Angle (D10) | 29° | | |
| H (distance) | 3.65mm | | |
| Dimension | Φ =75 mm, Thickness=33 mm | | |
| Luminous Flux | 1689 lm | Measured @ 12.6 W | |
| Material | PC / UL94V2 | | |

cd/klm

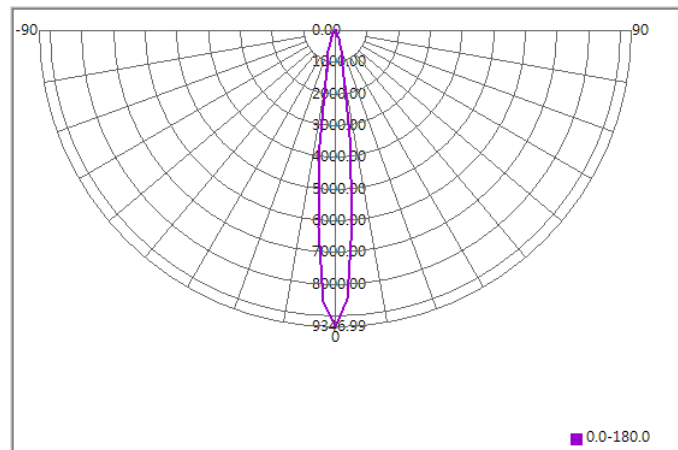

Illuminance At Distances

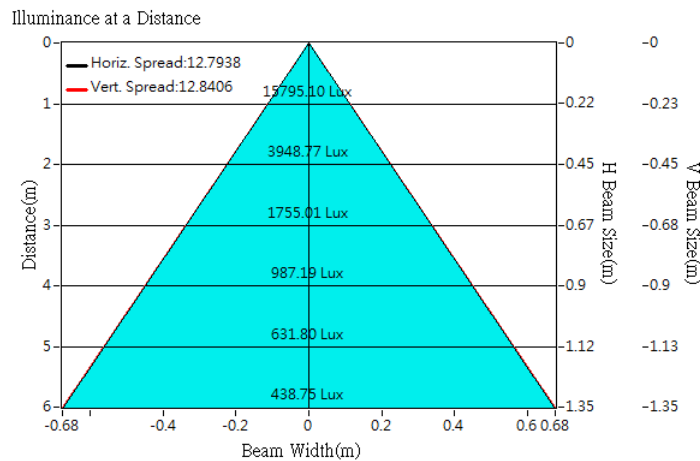



Optical Characteristics

| | | | |
|-------------------|---------------------------|-------------------|-----------------------|
| Model Number | CKO-CC20-075026-0401 | | <p>"H" definition</p> |
| LED | CLU 026 | | |
| LES / LED Size | Φ 9.8 mm | | |
| FWHM (D50) | 12° | | |
| Field Angle (D10) | 30° | | |
| H (distance) | 3.65mm | | |
| Dimension | Φ =75 mm, Thickness=33 mm | | |
| Luminous Flux | 1608 lm | Measured @ 12.5 W | |
| Material | PC / UL94V2 | | |

cd/klm

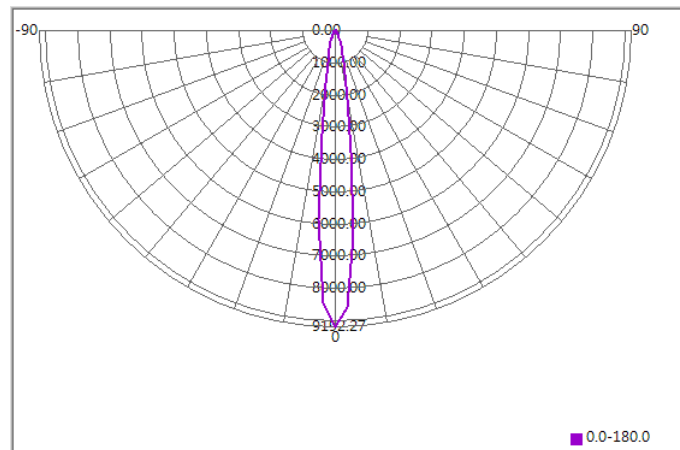

Illuminance At Distances

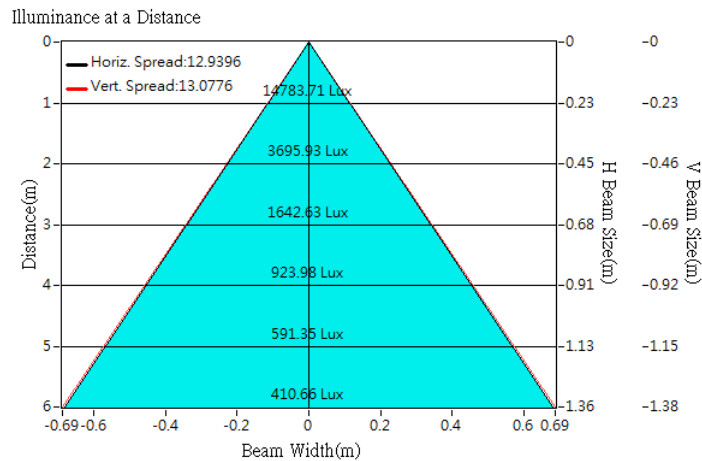



Optical Characteristics

| | | | |
|-------------------|----------------------------|-------------------|-----------------------|
| Model Number | CKO-CC20-075026-0401 | | <p>"H" definition</p> |
| LED | CLU 721 | | |
| LES / LED Size | Φ 11 mm | | |
| FWHM (D50) | 13° | | |
| Field Angle (D10) | 31° | | |
| H (distance) | 3.65 mm | | |
| Dimension | Φ =75mm, Thickness=25.4 mm | | |
| Luminous Flux | 4412 lm | Measured @ 38.3 W | |
| Material | PC / UL94V2 | | |

cd/klm

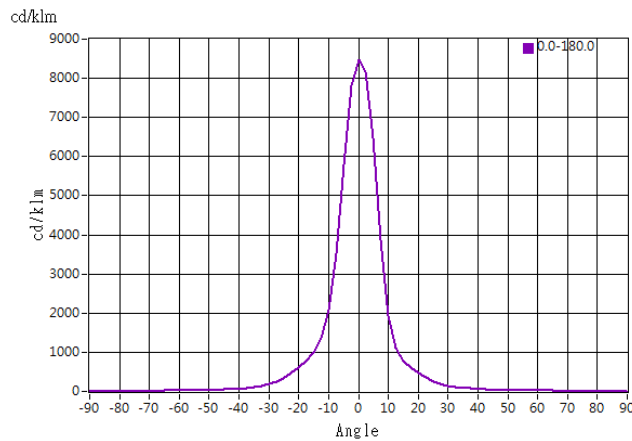

Illuminance At Distances

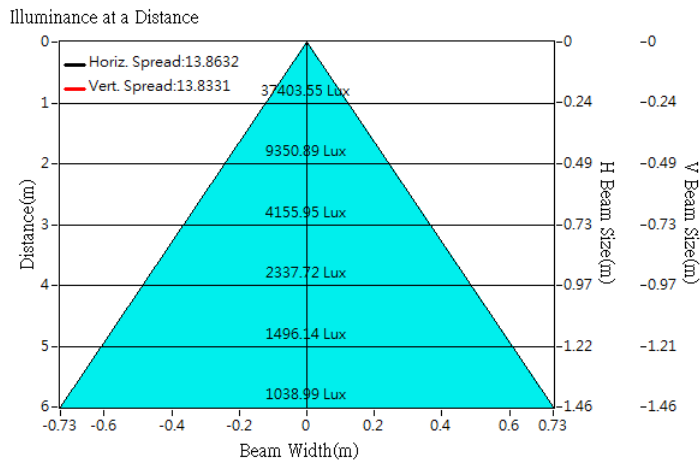



Optical Characteristics

| | | | |
|-------------------|----------------------------|-------------------|-----------------------|
| Model Number | CKO-CC20-075026-0401 | | <p>"H" definition</p> |
| LED | CLU 730 | | |
| LES / LED Size | Φ 13 mm | | |
| FWHM (D50) | 17° | | |
| Field Angle (D10) | 39° | | |
| H (distance) | 3.65 mm | | |
| Dimension | Φ =75mm, Thickness=25.4 mm | | |
| Luminous Flux | 4267 lm | Measured @ 62.9 W | |
| Material | PC / UL94V2 | | |

cd/klm

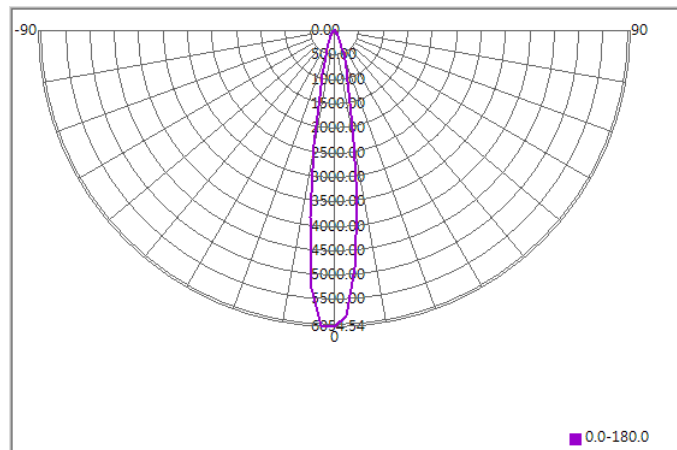

Illuminance At Distances

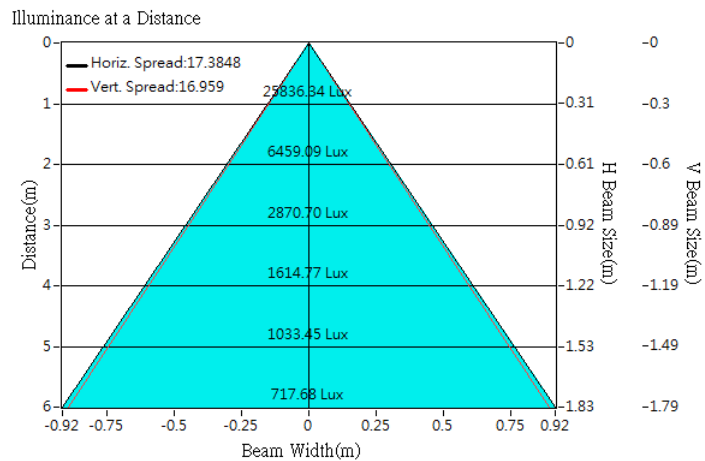



Optical Characteristics

| | | | |
|-------------------|----------------------------|-------------------|--|
| Model Number | CKO-CC20-075026-0401 | | <p>"H" definition</p> <p>LES CoB</p> |
| LED | CLU 036 | | |
| LES / LED Size | Φ 14.5 mm | | |
| FWHM (D50) | 19° | | |
| Field Angle (D10) | 43° | | |
| H (distance) | 3.65 mm | | |
| Dimension | Φ =75mm, Thickness=25.4 mm | | |
| Luminous Flux | 2035 lm | Measured @ 15.6 W | |
| Material | PC / UL94V2 | | |

cd/klm

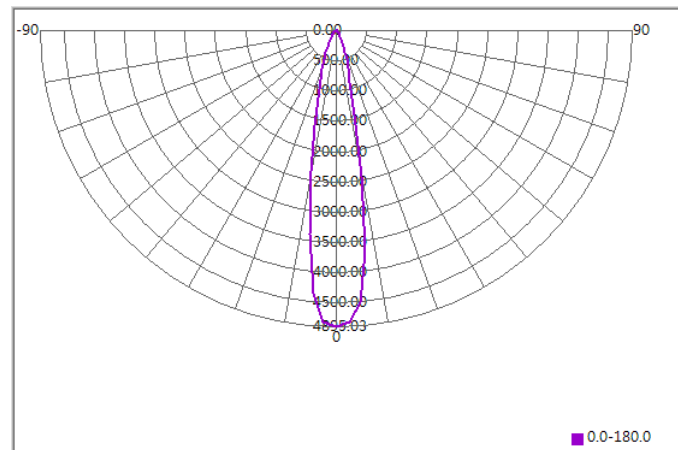

Illuminance At Distances

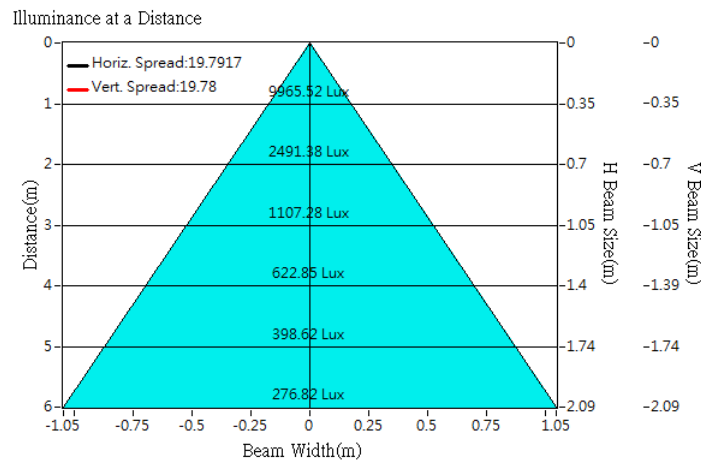

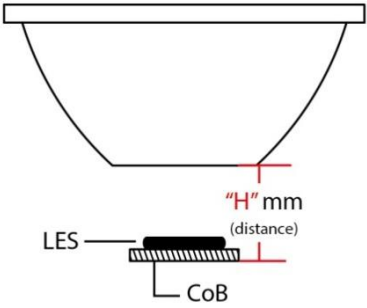

Optical Characteristics

| | | | |
|-------------------|----------------------------|-------------------|--|
| Model Number | CKO-CC20-075026-0401 | | <p>"H" definition</p>  |
| LED | CLU 038 | | |
| LES / LED Size | Φ 14.5 mm | | |
| FWHM (D50) | 17° | | |
| Field Angle (D10) | 40° | | |
| H (distance) | 3.65 mm | | |
| Dimension | Φ =75mm, Thickness=25.4 mm | | |
| Luminous Flux | 2938 lm | Measured @ 24.8 W | |
| Material | PC / UL94V2 | | |

cd/klm

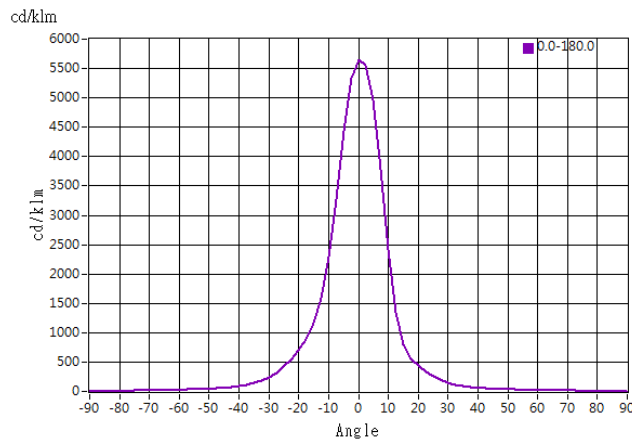

Illuminance At Distances

