



Product Model Number

CKO-CH15-045021-1605

✓ Model Number Definitions

CKO-XXXX-XXXXXX-XXXX



- A. Chun Kuang Optics Corp. Product
- B. Product Type: product abbreviation
Ex:
CH→CoB High Intensity
CC→CoB Compact
CS→Soft Shading for CoB LED
HC→Holder for CoB LED

- C. Identity Code
- D. Lens / Fixture Size
Ex: 075026=Φ75mm / Thickness=26mm (round up)
- C. Serial Numbers

The lens datasheet is applicable for **Philips LED**, that manufactured by Chun Kuang Optics Corp.

✓ Dimensions (mm) : Φ45 x 20.9

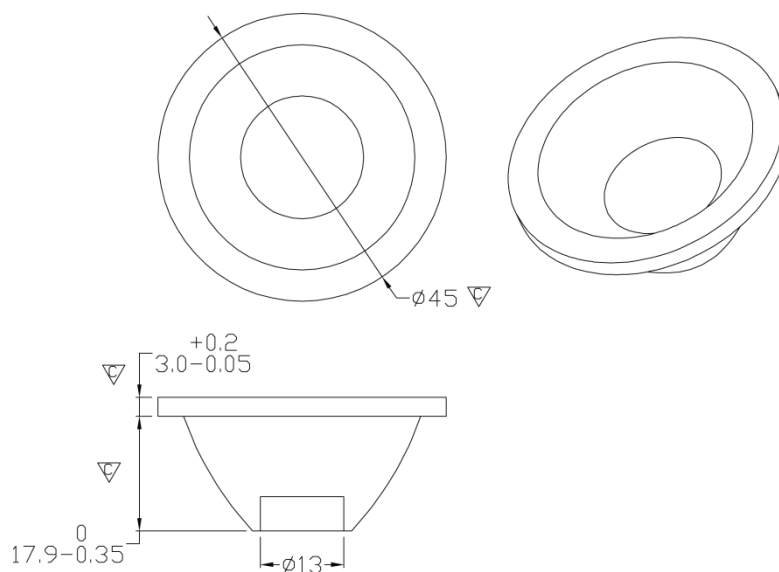

▽:Critical Dimension



✓ Optical Characteristics – Angle Performances

| Philips | LED LES (mm) | FWHM (degrees) | Field Angle (degrees) |
|----------------------------|--------------|----------------|-----------------------|
| Fortimo SLM 1202 L06 G7 | Φ6.5 | 28° | 56° |
| Fortimo SLM 1202 L06 G6 | Φ6.5 | 29° | 58° |
| Fortimo SLM 1203 L09 G6 | Φ9 | 35° | 68° |
| Fortimo SLM 1203 L09 G6_DL | Φ9 | 34° | 68° |
| Fortimo SLM 1203 L09 G6_PI | Φ9 | 34° | 68° |
| Fortimo SLM PW 1204 L09 G7 | Φ9 | 35° | 67° |
| Fortimo SLM 1201 L09 G7N | Φ9.8 | 36° | 72° |
| Fortimo SLM 1202 L09 G7N | Φ9.8 | 37° | 74° |
| Fortimo SLM 1204 L09 G7N | Φ9.8 | 37° | 74° |
| | | | |
| | | | |
| | | | |
| | | | |
| | | | |
| | | | |
| | | | |
| | | | |
| | | | |



Optical Characteristics

| | | | |
|-------------------|-----------------------------|----------------|-----------------------|
| Model Number | CKO-CH15-045021-1605 | | <p>"H" definition</p> |
| LED | Fortimo SLM 1202 L06 G7 | | |
| LES / LED Size | Φ 6.5 mm | | |
| FWHM (D50) | 28° | | |
| Field Angle (D10) | 56° | | |
| H (distance) | 2.5mm | | |
| Dimension | Φ =45 mm, Thickness=20.9 mm | | |
| Luminous Flux | 3100 lm | Measured @29 W | |
| Material | PC / UL94V2 | | |

cd/klm

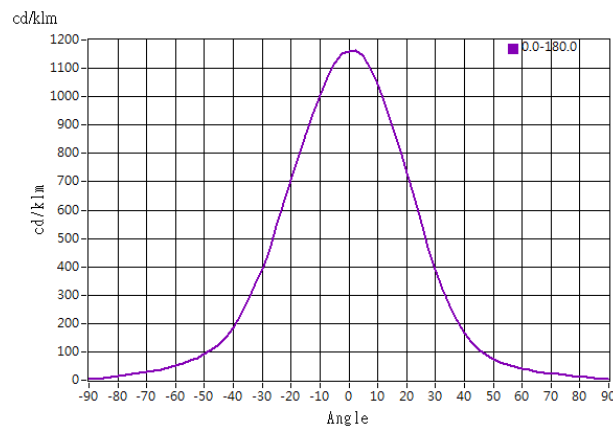

Illuminance At Distances

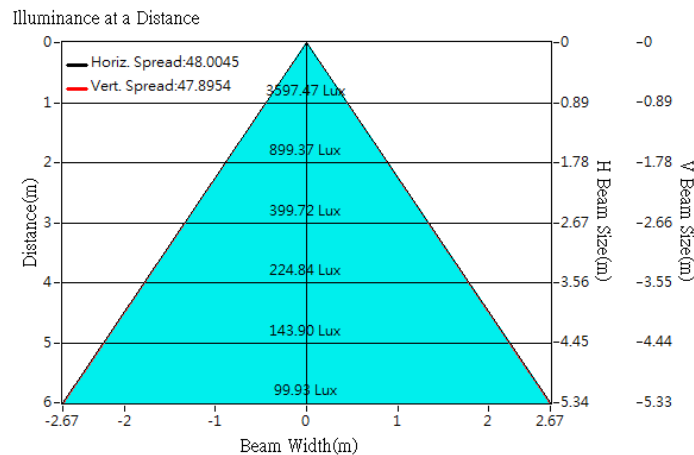



Optical Characteristics

| | | | |
|-------------------|--------------------------------|------------------|--|
| Model Number | CKO-CH15-045021-1605 | | |
| LED | Fortimo SLM 1202 L06 G6 | | |
| LES / LED Size | Φ 6.5 mm | | |
| FWHM (D50) | 29° | | |
| Field Angle (D10) | 58° | | |
| H (distance) | 2.5 mm | | |
| Dimension | Φ =45 mm, Thickness=20.9 mm | | |
| Luminous Flux | 869 lm | Measured @ 7.0 W | |
| Material | PC / UL94V2 | | |

cd/klm

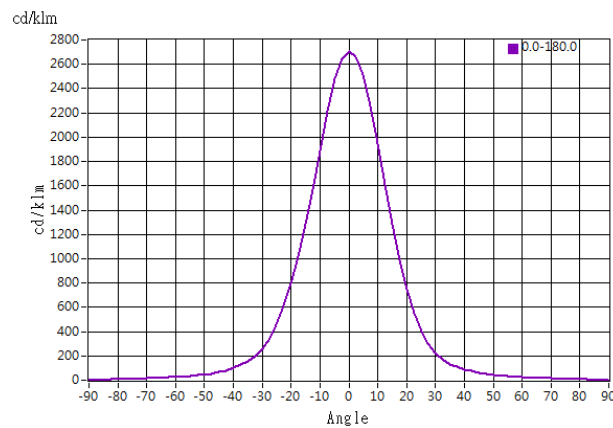

Illuminance At Distances

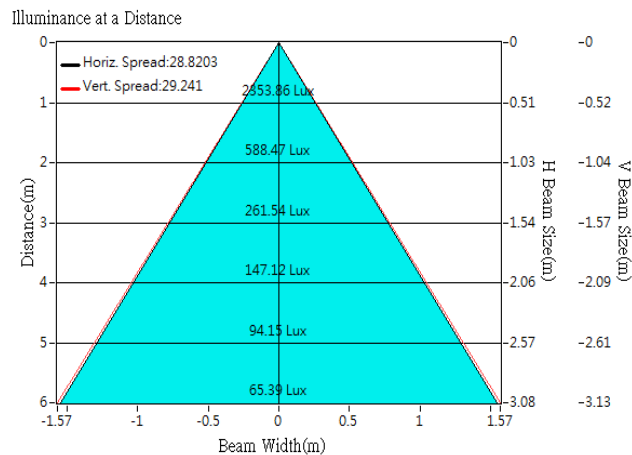



Optical Characteristics

| | | | |
|-------------------|--------------------------------|-------------------|-----------------------|
| Model Number | CKO-CH15-045021-1605 | | <p>"H" definition</p> |
| LED | Fortimo SLM 1203 L09 G6 | | |
| LES / LED Size | Φ 9 mm | | |
| FWHM (D50) | 35° | | |
| Field Angle (D10) | 68° | | |
| H (distance) | 2.5mm | | |
| Dimension | Φ =45 mm, Thickness=20.9 mm | | |
| Luminous Flux | 1260 lm | Measured @ 10.4 W | |
| Material | PC / UL94V2 | | |

cd/klm

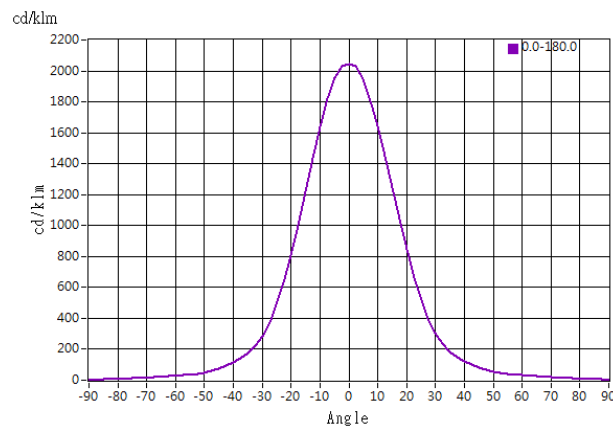

Illuminance At Distances

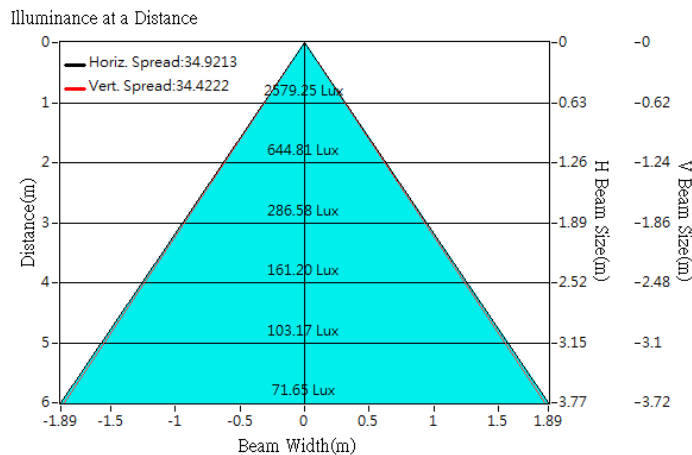



Optical Characteristics

| | | | |
|-------------------|-----------------------------------|-------------------|-----------------------|
| Model Number | CKO-CH15-045021-1605 | | <p>"H" definition</p> |
| LED | Fortimo SLM C 1203 L09 1619 G6_DL | | |
| LES / LED Size | Φ 9 mm | | |
| FWHM (D50) | 34° | | |
| Field Angle (D10) | 68° | | |
| H (distance) | 3.5mm | | |
| Dimension | Φ =45 mm, Thickness=20.9 mm | | |
| Luminous Flux | 1176 lm | Measured @ 10.4 W | |
| Material | PC / UL94V2 | | |

cd/klm

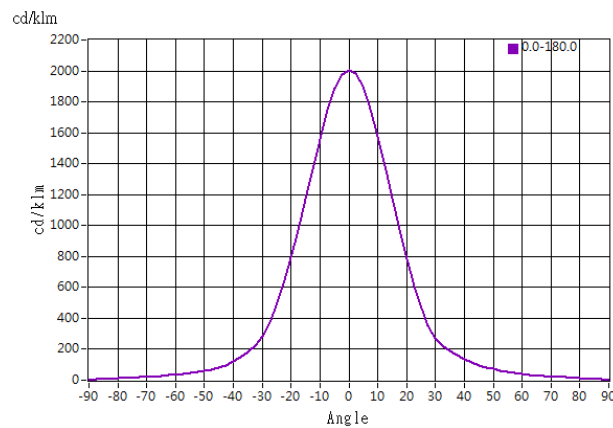

Illuminance At Distances

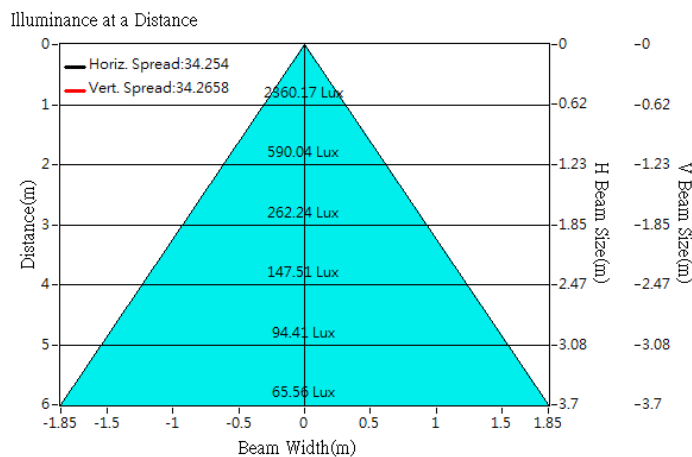



Optical Characteristics

| | | | |
|-------------------|-----------------------------------|-------------------|---|
| Model Number | CKO-CH15-045021-1605 | | <p>"H" definition</p> <p>LES</p> <p>CoB</p> |
| LED | Fortimo SLM C 1203 L09 1619 G6_PI | | |
| LES / LED Size | Φ 9 mm | | |
| FWHM (D50) | 34° | | |
| Field Angle (D10) | 68° | | |
| H (distance) | 3.5mm | | |
| Dimension | Φ =45 mm, Thickness=20.9 mm | | |
| Luminous Flux | 1176 lm | Measured @ 10.4 W | |
| Material | PC / UL94V2 | | |

cd/klm

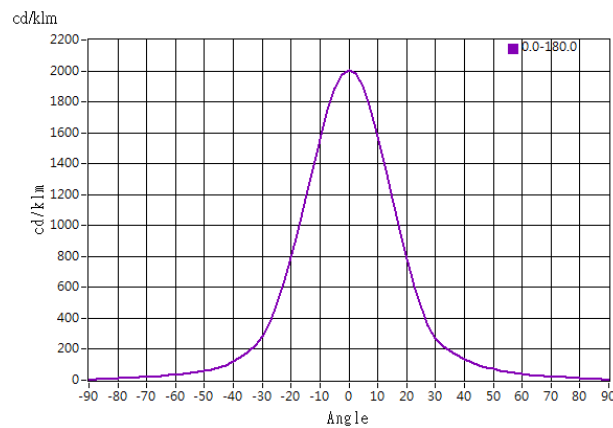

Illuminance At Distances

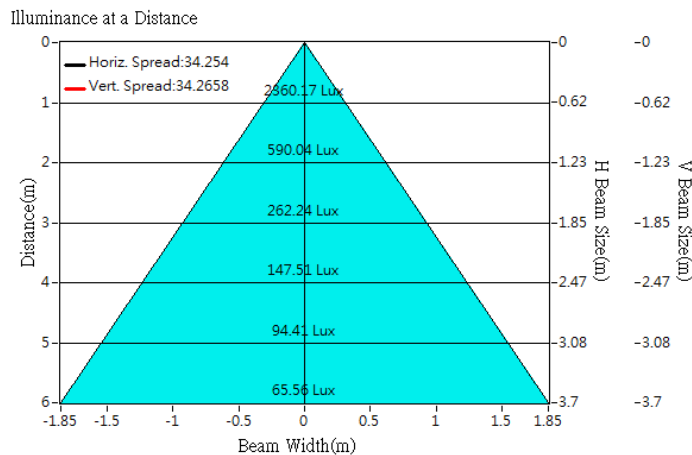



Optical Characteristics

| | | | |
|-------------------|-----------------------------|------------------|-----------------------|
| Model Number | CKO-CH15-045021-1605 | | <p>"H" definition</p> |
| LED | Fortimo SLM 1201 L09 G7N | | |
| LES / LED Size | Φ 9.8 mm | | |
| FWHM (D50) | 36° | | |
| Field Angle (D10) | 72° | | |
| H (distance) | 2.5mm | | |
| Dimension | Φ =45 mm, Thickness=20.9 mm | | |
| Luminous Flux | 449 lm | Measured @ 3.0 W | |
| Material | PC / UL94V2 | | |

cd/klm

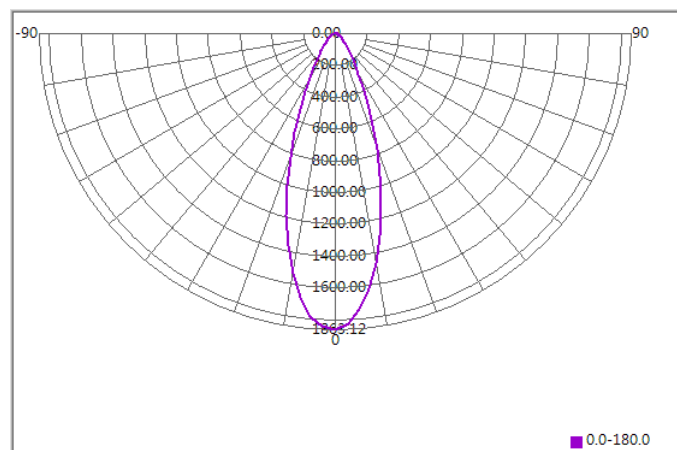

Illuminance At Distances

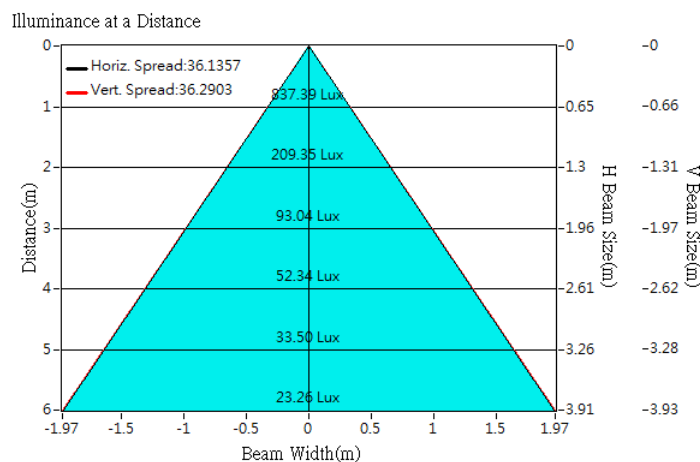



Optical Characteristics

| | | | |
|-------------------|-----------------------------|------------------|--|
| Model Number | CKO-CH15-045021-1605 | | |
| LED | Fortimo SLM 1202 L09 G7N | | |
| LES / LED Size | Φ 9.8 mm | | |
| FWHM (D50) | 37° | | |
| Field Angle (D10) | 74° | | |
| H (distance) | 2.5mm | | |
| Dimension | Φ =45 mm, Thickness=20.9 mm | | |
| Luminous Flux | 851 lm | Measured @ 6.1 W | |
| Material | PC / UL94V2 | | |

cd/klm

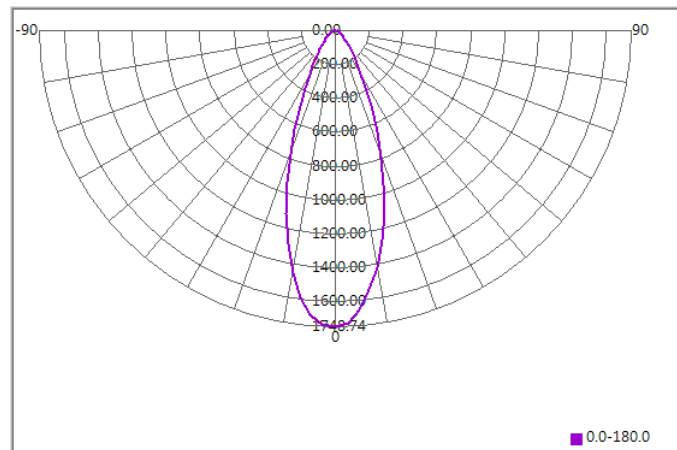

Illuminance At Distances

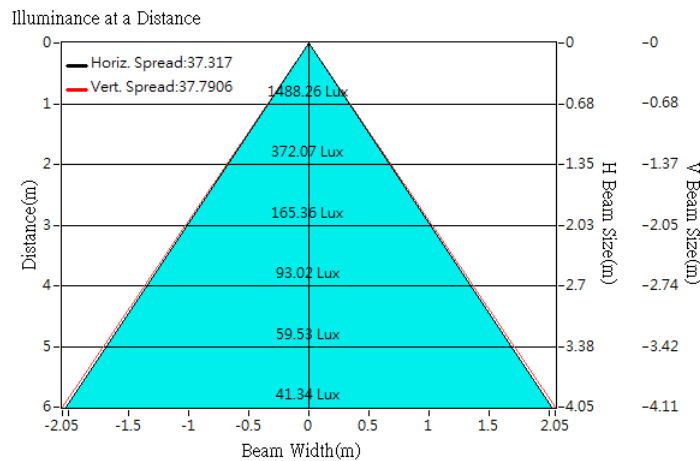



Optical Characteristics

| | | | |
|-------------------|-----------------------------|-------------------|-----------------------|
| Model Number | CKO-CH15-045021-1605 | | <p>"H" definition</p> |
| LED | Fortimo SLM 1204 L09 G7N | | |
| LES / LED Size | Φ 9.8 mm | | |
| FWHM (D50) | 37° | | |
| Field Angle (D10) | 74° | | |
| H (distance) | 2.5mm | | |
| Dimension | Φ =45 mm, Thickness=20.9 mm | | |
| Luminous Flux | 1665 lm | Measured @ 12.3 W | |
| Material | PC / UL94V2 | | |

cd/klm

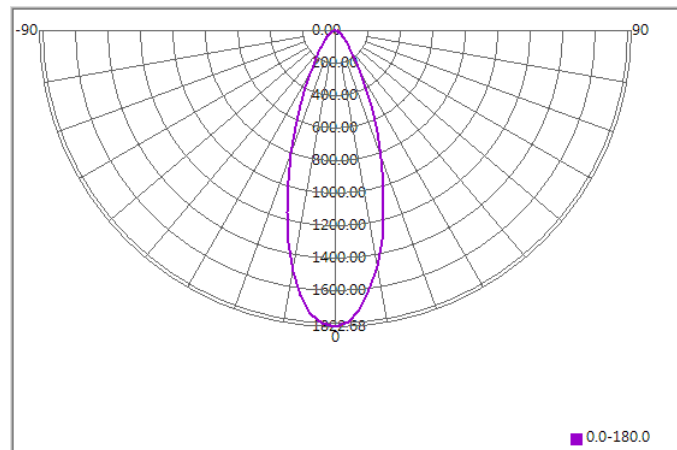

Illuminance At Distances

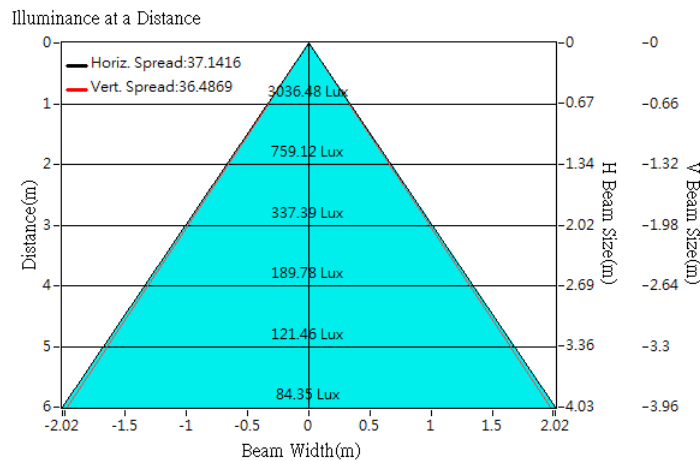



Optical Characteristics

| | | | |
|-------------------|--------------------------------|-------------------|-----------------------|
| Model Number | CKO-CH15-045021-1605 | | <p>"H" definition</p> |
| LED | Fortimo SLM 1204 L09 G7 | | |
| LES / LED Size | Φ 9 mm | | |
| FWHM (D50) | 35° | | |
| Field Angle (D10) | 67° | | |
| H (distance) | 2.5mm | | |
| Dimension | Φ =45 mm, Thickness=20.9 mm | | |
| Luminous Flux | 2003 lm | Measured @ 21.6 W | |
| Material | PC / UL94V2 | | |

cd/klm

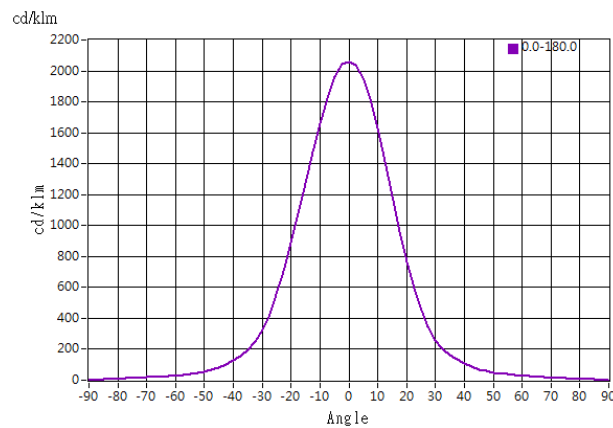

Illuminance At Distances

