



Product Model Number

CKO-CH15-045021-1650

✓ Model Number Definitions

CKO-XXXX-XXXXXX-XXXX



- A. Chun Kuang Optics Corp. Product
- B. Product Type: product abbreviation
Ex:
CH→CoB High Intensity
CC→CoB Compact
CS→Soft Shading for CoB LED
HC→Holder for CoB LED

- C. Identity Code
- D. Lens / Fixture Size
Ex: 075026=Φ75mm / Thickness=26mm (round up)
- C. Serial Numbers

The lens datasheet is applicable for **Philips LED**, that manufactured by Chun Kuang Optics Corp.

✓ Dimensions (mm) : Φ45 x 20.9

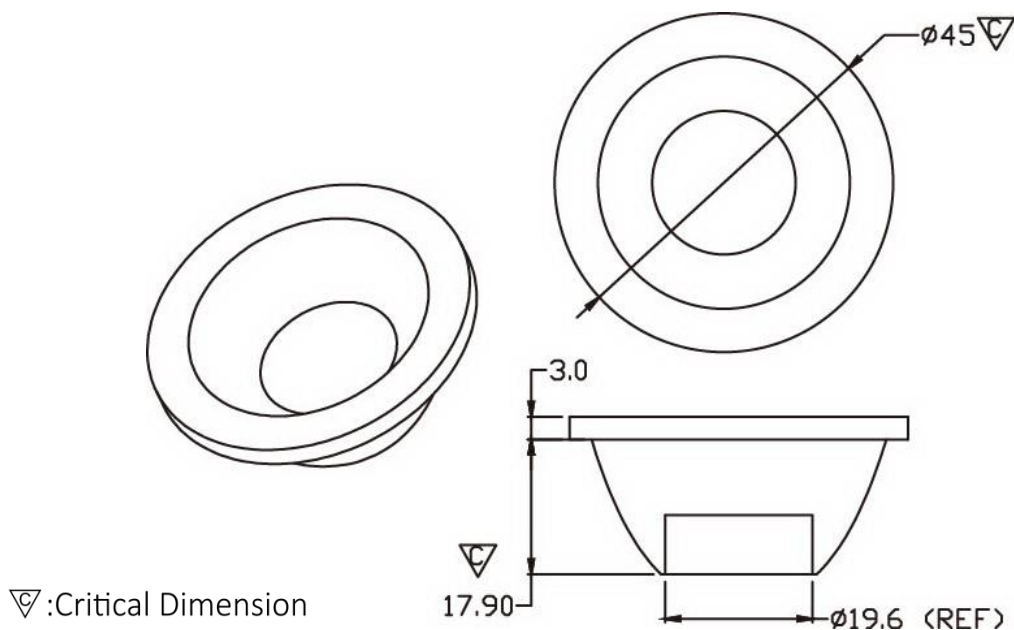



✓ Optical Characteristics – Angle Performances

Philips	LED LES (mm)	FWHM (degrees)	Field Angle (degrees)
Fortimo SLM 1202 L06 G7	Φ6.5	49°	85°
Fortimo SLM 1202 L06 G6	Φ6.5	50°	85°
Fortimo SLM 1203 L09 G6	Φ9	53°	90°
Fortimo SLM 1203 L09 G6_DL	Φ9	48°	85°
Fortimo SLM 1203 L09 G6_PI	Φ9	48°	85°
Fortimo SLM PW 1204 L09 G7	Φ9	53°	90°
Fortimo SLM 1201 L09 G7N	Φ9.8	52°	89°
Fortimo SLM 1202 L09 G7N	Φ9.8	51°	89°
Fortimo SLM 1204 L09 G7N	Φ9.8	52°	90°



Optical Characteristics

Model Number	CKO-CH15-045021-1650		<p>"H" definition</p>
LED	Fortimo SLM 1202 L06 G7		
LES / LED Size	Φ 6.5 mm		
FWHM (D50)	49°		
Field Angle (D10)	85°		
H (distance)	2.5 mm		
Dimension	Φ =45 mm, Thickness=20.9 mm		
Luminous Flux	853 lm	Measured @ 7 W	
Material	PC / UL94V2		

cd/klm

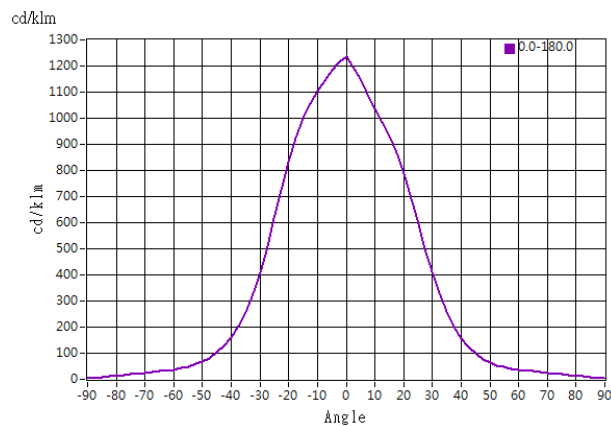

Illuminance At Distances

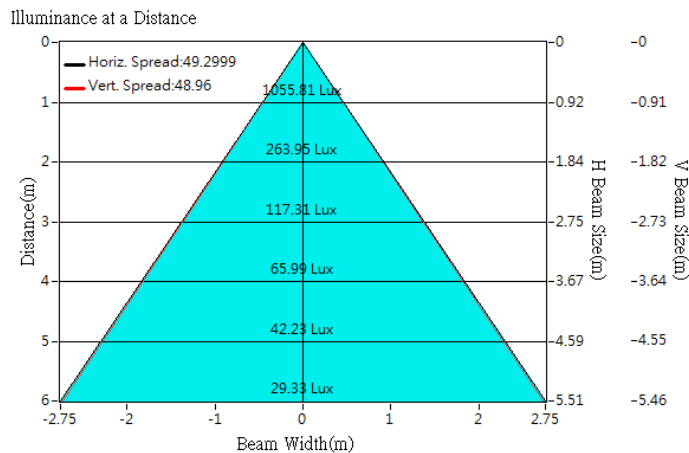



Optical Characteristics

Model Number	CKO-CH15-045021-1650	<p>"H" definition</p>
LED	Fortimo SLM 1202 L06 G6	
LES / LED Size	Φ 6.5 mm	
FWHM (D50)	50°	
Field Angle (D10)	85°	
H (distance)	2.5 mm	
Dimension	Φ =45 mm, Thickness=20.9 mm	
Luminous Flux	826 lm	
Material	PC / UL94V2	

cd/klm

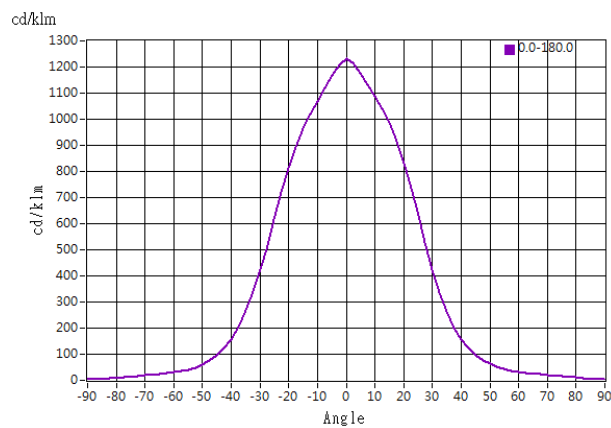

Illuminance At Distances

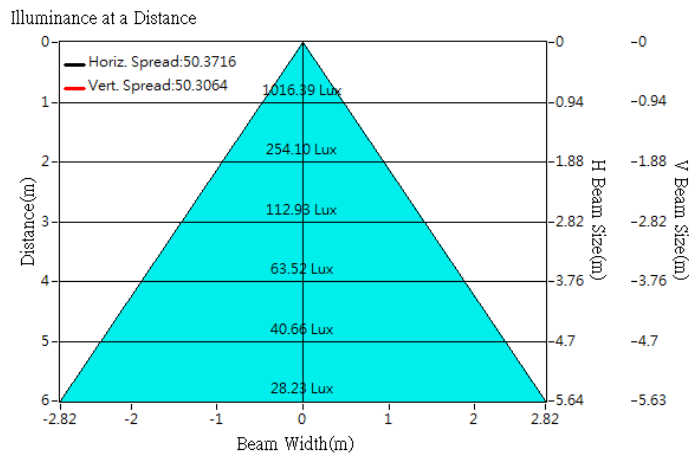



Optical Characteristics

Model Number	CKO-CH15-045021-1650		<p>"H" definition</p>
LED	Fortimo SLM 1203 L09 G6		
LES / LED Size	Φ 9 mm		
FWHM (D50)	53°		
Field Angle (D10)	90°		
H (distance)	2.5mm		
Dimension	Φ =45 mm, Thickness=20.9 mm		
Luminous Flux	1182 lm	Measured @ 10.5 W	
Material	PC / UL94V2		

cd/klm

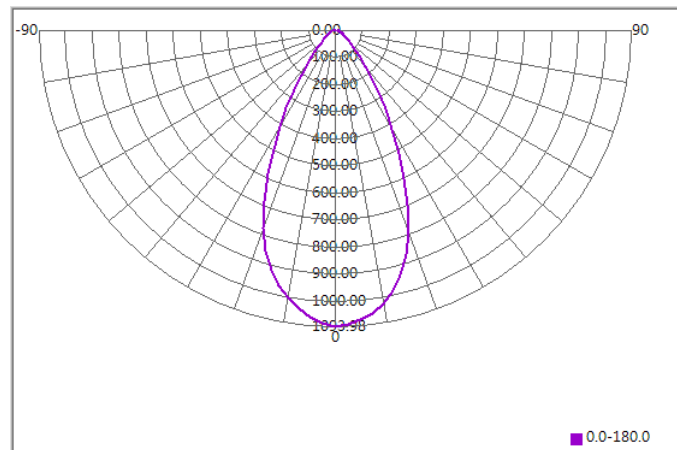

Illuminance At Distances

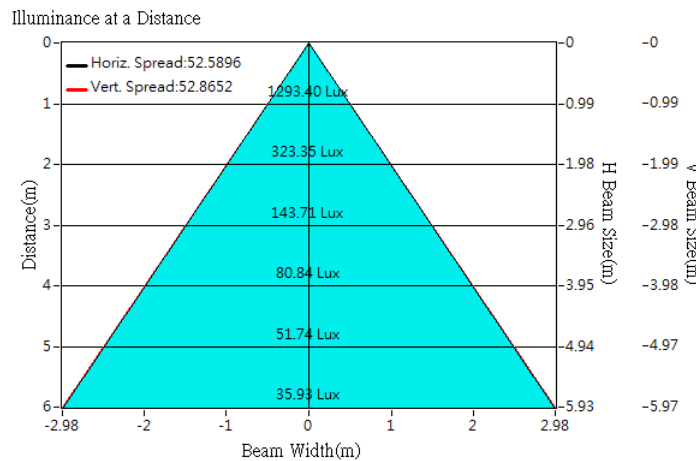



Optical Characteristics

Model Number	CKO-CH15-045021-1650		<p>"H" definition</p>
LED	Fortimo SLM 1203 L09 G6_DL		
LES / LED Size	Φ 9 mm		
FWHM (D50)	48°		
Field Angle (D10)	85°		
H (distance)	3.5 mm		
Dimension	Φ =45 mm, Thickness=20.9 mm		
Luminous Flux	1191 lm	Measured @ 10.5 W	
Material	PC / UL94V2		

cd/klm

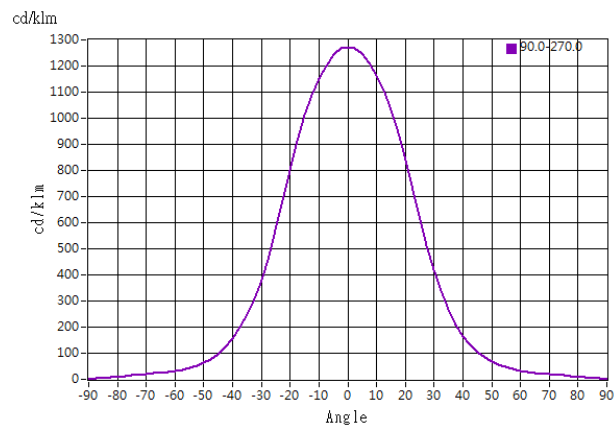

Illuminance At Distances

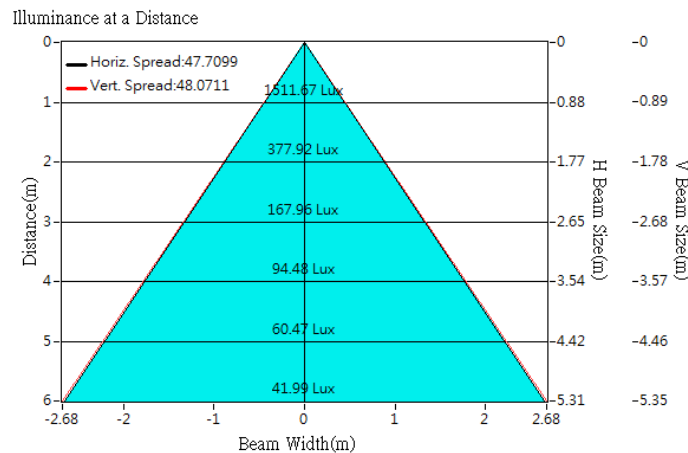



Optical Characteristics

Model Number	CKO-CH15-045021-1650		<p>"H" definition</p>
LED	Fortimo SLM 1203 L09 G6_PI		
LES / LED Size	Φ 9 mm		
FWHM (D50)	48°		
Field Angle (D10)	85°		
H (distance)	3.5 mm		
Dimension	Φ =45 mm, Thickness=20.9 mm		
Luminous Flux	1191 lm	Measured @ 10.5 W	
Material	PC / UL94V2		

cd/klm

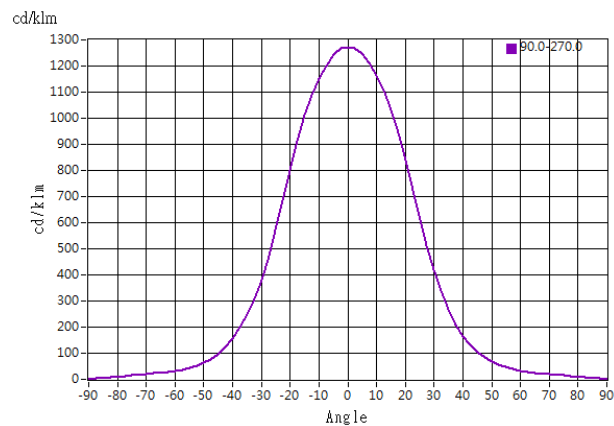

Illuminance At Distances

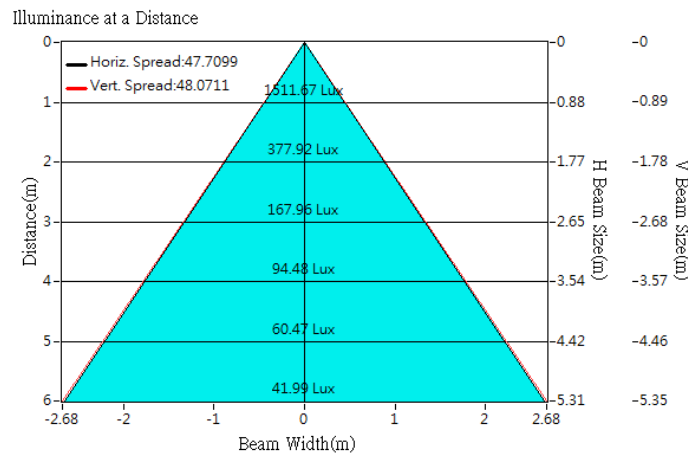



Optical Characteristics

Model Number	CKO-CH15-045021-1650		
LED	Fortimo SLM PW 1204 L09 G7		
LES / LED Size	Φ 9 mm		
FWHM (D50)	53°		
Field Angle (D10)	90°		
H (distance)	2.5 mm		
Dimension	Φ =45 mm, Thickness=20.9 mm		
Luminous Flux	2465 lm	Measured @ 25.4 W	
Material	PC / UL94V2		

cd/klm

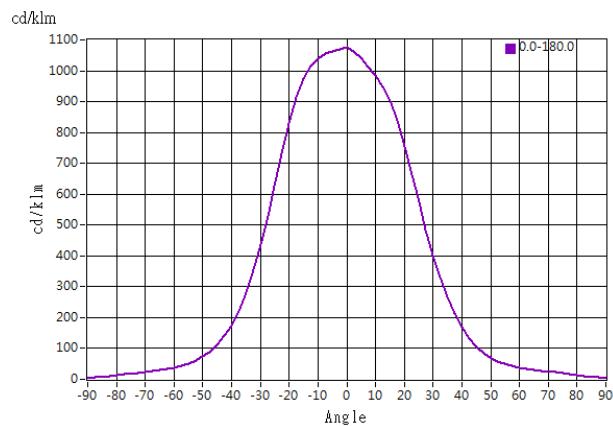

Illuminance At Distances

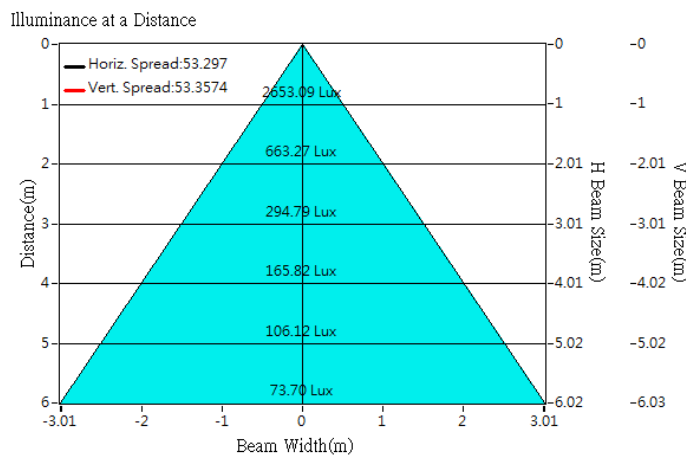



Optical Characteristics

Model Number	CKO-CH15-045021-1650		<p>"H" definition</p> <p>LES</p> <p>CoB</p>
LED	Fortimo SLM 1201 L09 G7N		
LES / LED Size	Φ 9.8 mm		
FWHM (D50)	52°		
Field Angle (D10)	89°		
H (distance)	2.5mm		
Dimension	Φ =45 mm, Thickness=20.9 mm		
Luminous Flux	449 lm	Measured @ 3.0 W	
Material	PC / UL94V2		

cd/klm

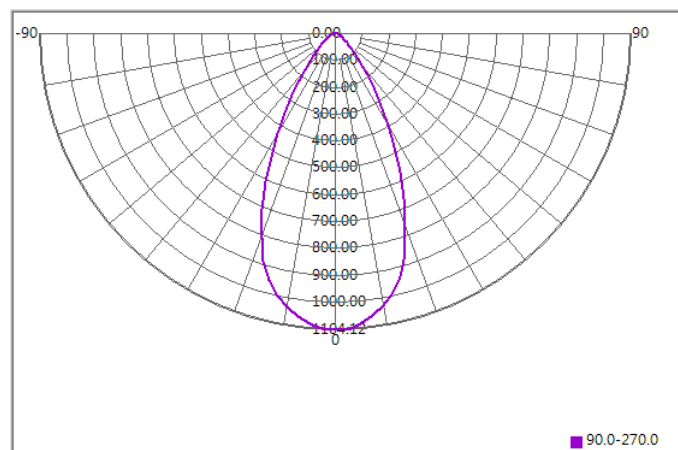

Illuminance At Distances

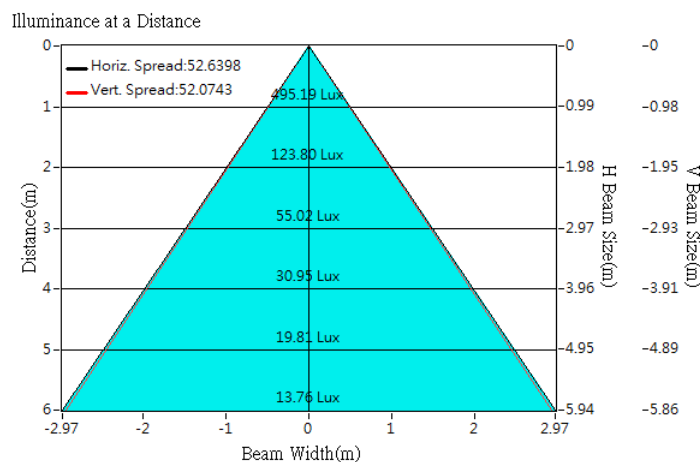



Optical Characteristics

Model Number	CKO-CH15-045021-1650		<p>"H" definition</p> <p>LES</p> <p>CoB</p>
LED	Fortimo SLM 1202 L09 G7N		
LES / LED Size	Φ 9.8 mm		
FWHM (D50)	51°		
Field Angle (D10)	89°		
H (distance)	2.5mm		
Dimension	Φ =45 mm, Thickness=20.9 mm		
Luminous Flux	858 lm	Measured @ 6.1 W	
Material	PC / UL94V2		

cd/klm

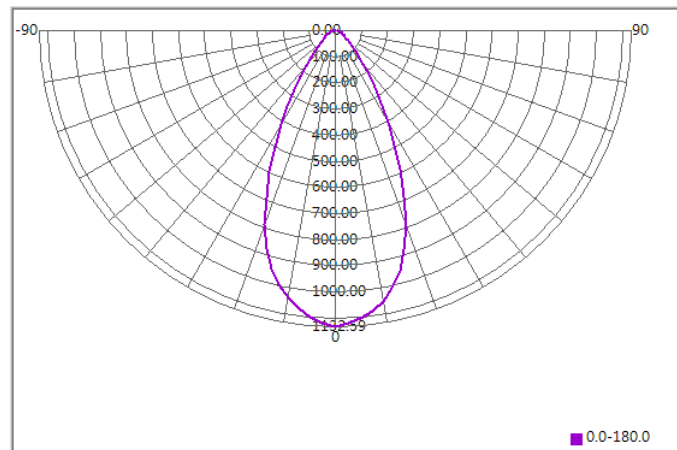

Illuminance At Distances

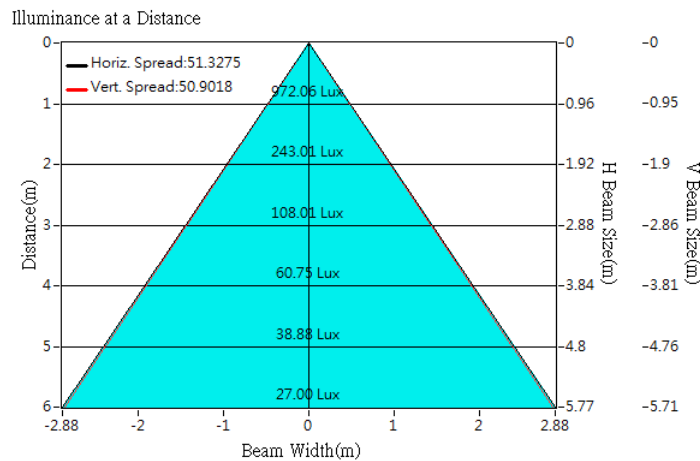



Optical Characteristics

Model Number	CKO-CH15-045021-1650		<p>"H" definition</p> <p>LES</p> <p>CoB</p>
LED	Fortimo SLM 1204 L09 G7N		
LES / LED Size	Φ 9.8 mm		
FWHM (D50)	52°		
Field Angle (D10)	90°		
H (distance)	2.5mm		
Dimension	Φ =45 mm, Thickness=20.9 mm		
Luminous Flux	1668 lm	Measured @ 12.3 W	
Material	PC / UL94V2		

cd/klm

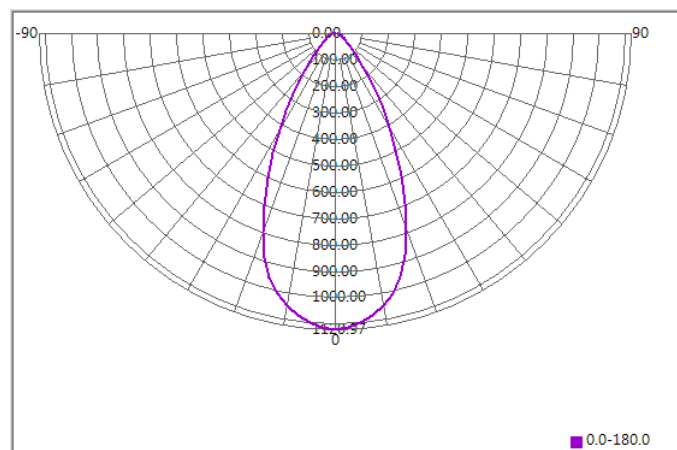

Illuminance At Distances

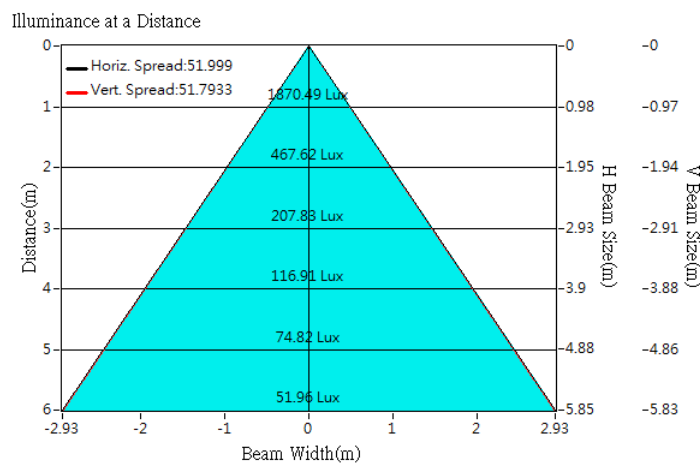



Lens Accessories - CoB Holder

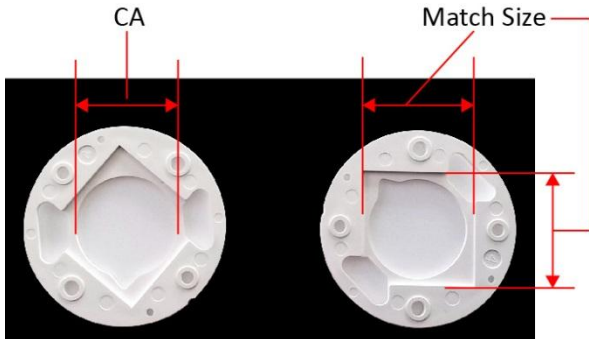

Example of LES Area & LED Size Dimension Locations

Product Model	Match Size (mm)	CA (mm)	Material	Applicability
CKO-HC14-161911-0501	16.3 x 19.3	Φ 11.9	PBT	Philips 1202
CKO-HC14-161911-0501	16.3 x 19.3	Φ 11.9	PBT	Philips 1203
CKO-HC14-202419-0502	20.3 x 24.3	Φ 19.2	PBT	Philips 1204
CKO-HC14-202419-0502	20.3 x 24.3	Φ 19.2	PBT	Philips 1205