



## Product Model Number

CKO-CH15-045021-1660

### ✓ Model Number Definitions

**CKO-XXXX-XXXXXX-XXXX**



- A. Chun Kuang Optics Corp. Product
- B. Product Type: product abbreviation  
Ex:  
CH→CoB High Intensity  
CC→CoB Compact  
CS→Soft Shading for CoB LED  
HC→Holder for CoB LED

- C. Identity Code
- D. Lens / Fixture Size  
Ex: 075026=Φ75mm / Thickness=26mm (round up)
- E. Serial Numbers

The lens datasheet is applicable for **CREE LED**, that manufactured by Chun Kuang Optics Corp.

### ✓ Dimensions (mm) : Φ45 x 20.9

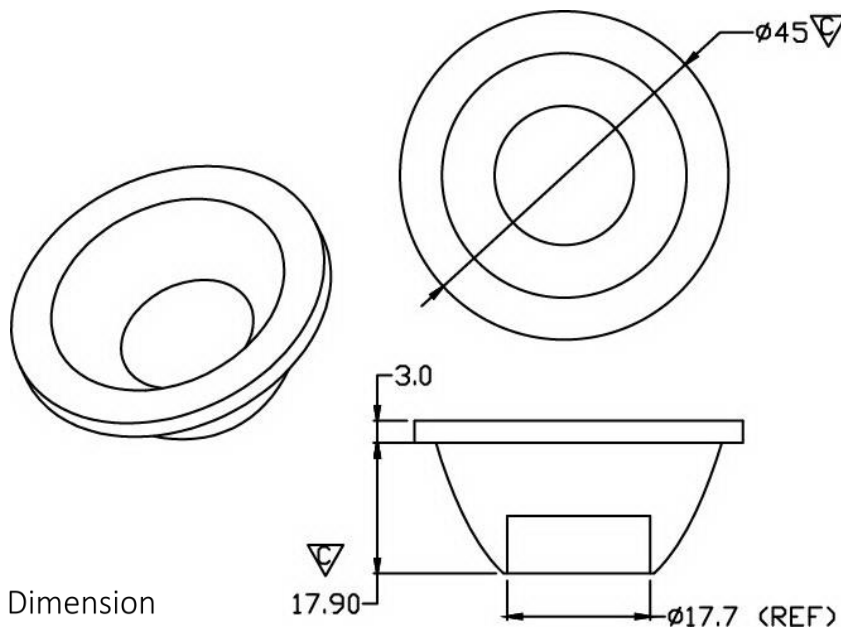

▽:Critical Dimension





## Optical Characteristics

|                   |                             |                  |                       |
|-------------------|-----------------------------|------------------|-----------------------|
| Model Number      | CKO-CH15-045021-1660        |                  | <p>"H" definition</p> |
| LED               | <b>CMA1303</b>              |                  |                       |
| LES / LED Size    | Φ 4.5 mm                    |                  |                       |
| FWHM (D50)        | 59°                         |                  |                       |
| Field Angle (D10) | 100°                        |                  |                       |
| H (distance)      | 2.5mm                       |                  |                       |
| Dimension         | Φ =45 mm, Thickness=20.9 mm |                  |                       |
| Luminous Flux     | 667 lm                      | Measured @ 6.7 W |                       |
| Material          | PC / UL94V2                 |                  |                       |

## cd/klm

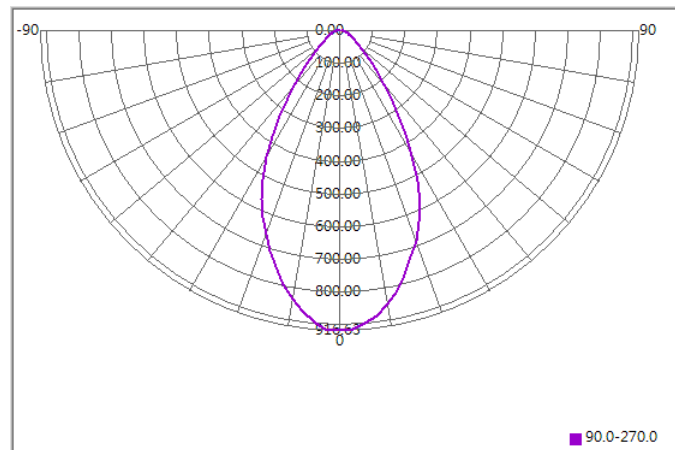

## Illuminance At Distances

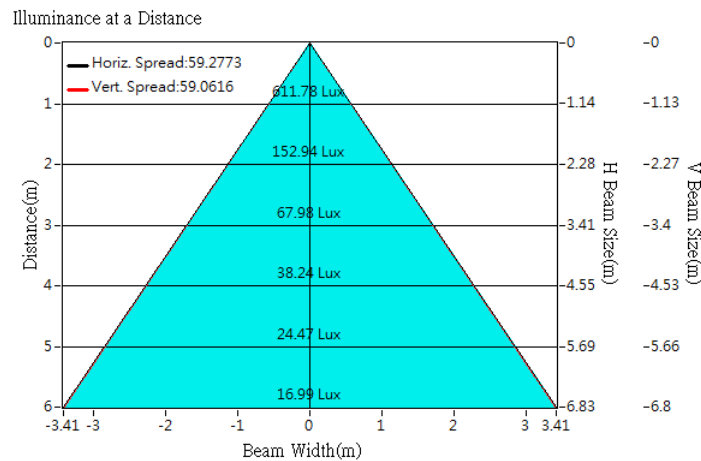



## Optical Characteristics

|                   |                             |                  |                       |
|-------------------|-----------------------------|------------------|-----------------------|
| Model Number      | CKO-CH15-045021-1660        |                  | <p>"H" definition</p> |
| LED               | <b>CREE CXA1304</b>         |                  |                       |
| LES / LED Size    | Φ 6 mm                      |                  |                       |
| FWHM (D50)        | 58°                         |                  |                       |
| Field Angle (D10) | 99°                         |                  |                       |
| H (distance)      | 2.5mm                       |                  |                       |
| Dimension         | Φ =45 mm, Thickness=20.9 mm |                  |                       |
| Luminous Flux     | 353 lm                      | Measured @ 3.7 W |                       |
| Material          | PC / UL94V2                 |                  |                       |

## cd/klm

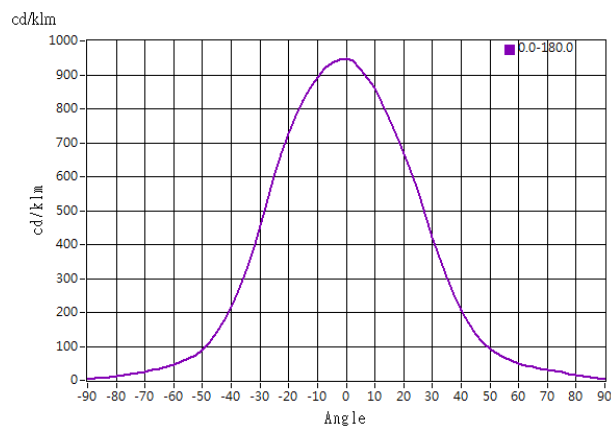

## Illuminance At Distances

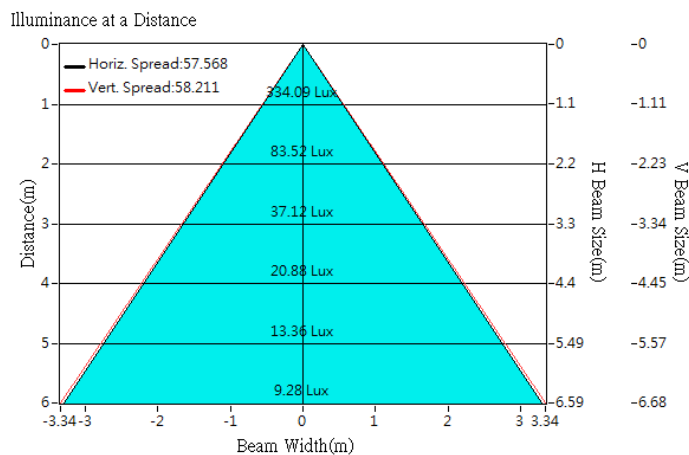



## Optical Characteristics

|                   |                             |                       |
|-------------------|-----------------------------|-----------------------|
| Model Number      | CKO-CH15-045021-1660        | <p>"H" definition</p> |
| LED               | <b>CXB1304</b>              |                       |
| LES / LED Size    | Φ 6 mm                      |                       |
| FWHM (D50)        | 63°                         |                       |
| Field Angle (D10) | 106°                        |                       |
| H (distance)      | 2.5mm                       |                       |
| Dimension         | Φ =45 mm, Thickness=20.9 mm |                       |
| Luminous Flux     | 402 lm                      |                       |
| Material          | PC / UL94V2                 |                       |

## cd/klm

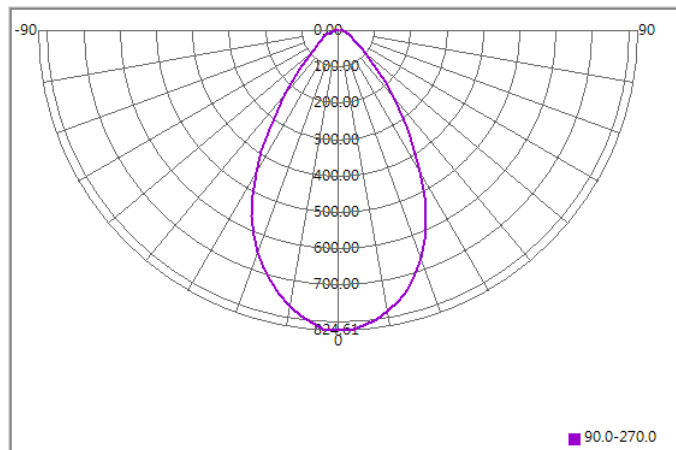

## Illuminance At Distances

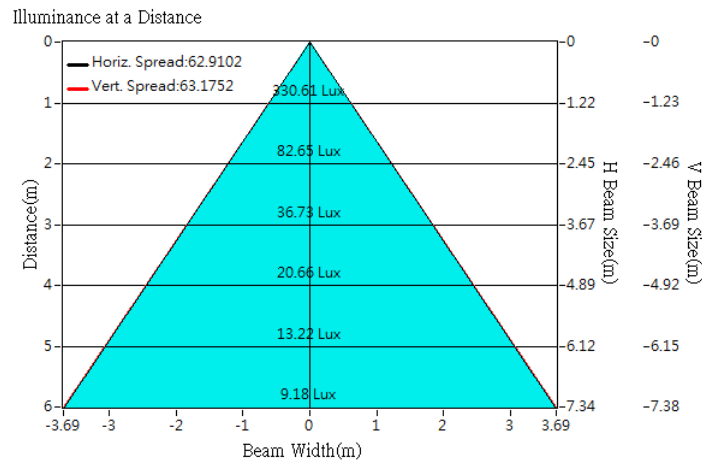



## Optical Characteristics

|                   |                             |                  |  |
|-------------------|-----------------------------|------------------|--|
| Model Number      | CKO-CH15-045021-1660        |                  | <p>"H" definition</p> <p>LES<br/>CoB</p> |
| LED               | <b>CMA1306</b>              |                  |  |
| LES / LED Size    | Φ 6 mm                      |                  |  |
| FWHM (D50)        | 58°                         |                  |  |
| Field Angle (D10) | 99°                         |                  |  |
| H (distance)      | 2.5mm                       |                  |  |
| Dimension         | Φ =45 mm, Thickness=20.9 mm |                  |  |
| Luminous Flux     | 731 lm                      | Measured @ 6.2 W |  |
| Material          | PC / UL94V2                 |                  |  |

## cd/klm

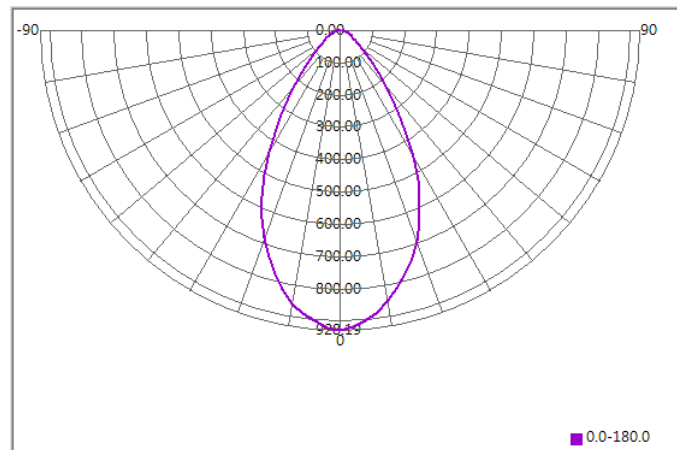

## Illuminance At Distances

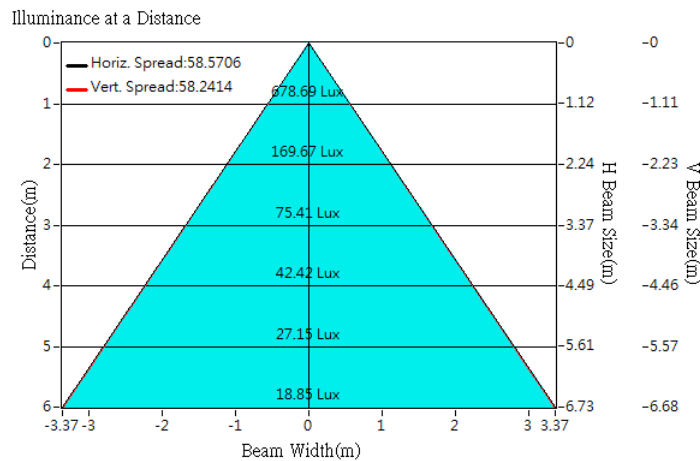



## Optical Characteristics

|                   |                             |                       |
|-------------------|-----------------------------|-----------------------|
| Model Number      | CKO-CH15-045021-1660        | <p>"H" definition</p> |
| LED               | <b>CREE CXB1310</b>         |                       |
| LES / LED Size    | Φ 6 mm                      |                       |
| FWHM (D50)        | 60°                         |                       |
| Field Angle (D10) | 101°                        |                       |
| H (distance)      | 2.5mm                       |                       |
| Dimension         | Φ =45 mm, Thickness=20.9 mm |                       |
| Luminous Flux     | 1289 lm                     |                       |
| Material          | PC / UL94V2                 |                       |

## cd/klm

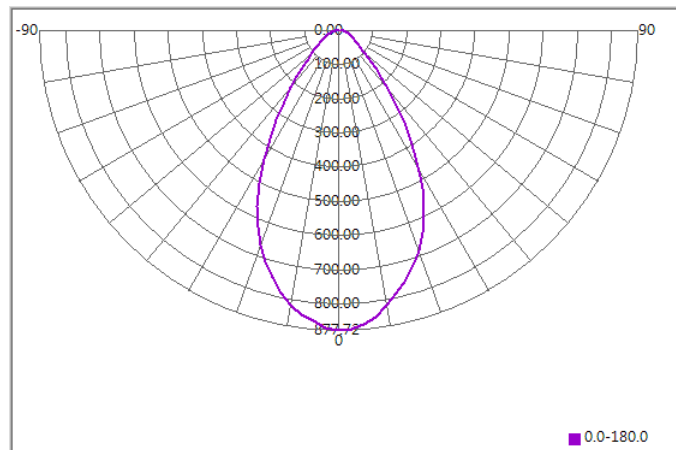

## Illuminance At Distances

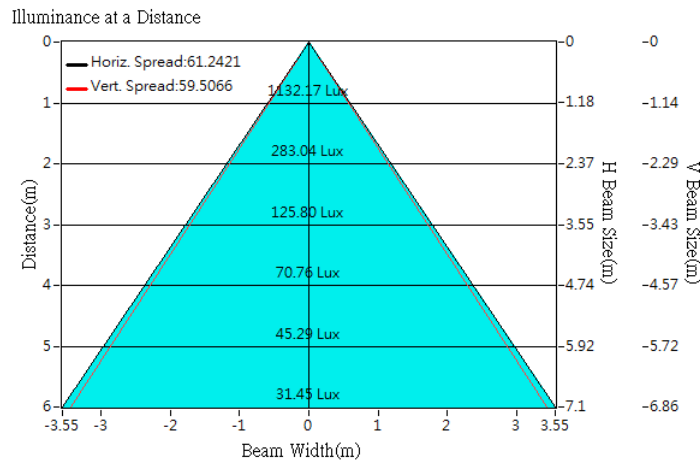



## Optical Characteristics

|                   |                             |                 |                       |
|-------------------|-----------------------------|-----------------|-----------------------|
| Model Number      | CKO-CH15-045021-1660        |                 | <p>"H" definition</p> |
| LED               | <b>CREE CXA1507</b>         |                 |                       |
| LES / LED Size    | Φ 9 mm                      |                 |                       |
| FWHM (D50)        | 59°                         |                 |                       |
| Field Angle (D10) | 101°                        |                 |                       |
| H (distance)      | 2.5mm                       |                 |                       |
| Dimension         | Φ =45 mm, Thickness=20.9 mm |                 |                       |
| Luminous Flux     | 654 lm                      | Measured @7.3 W |                       |
| Material          | PC / UL94V2                 |                 |                       |

## cd/klm

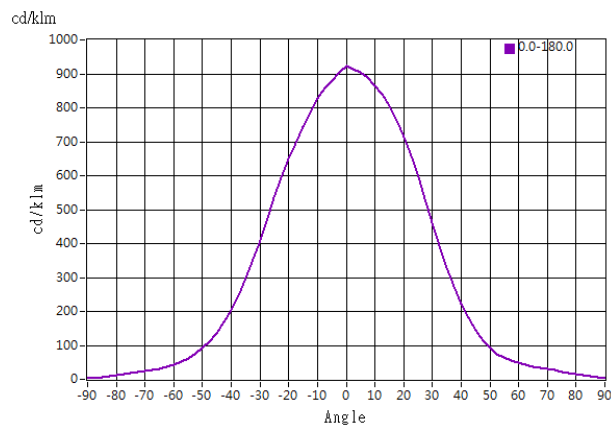

## Illuminance At Distances

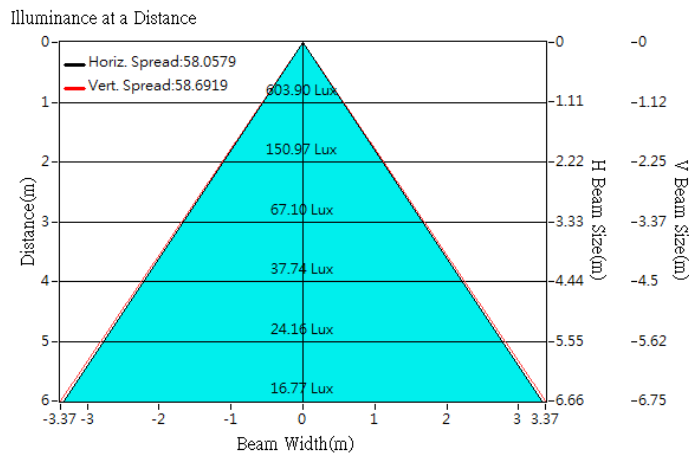



## Optical Characteristics

|                   |                             |                  |                       |
|-------------------|-----------------------------|------------------|-----------------------|
| Model Number      | CKO-CH15-045021-1660        |                  | <p>"H" definition</p> |
| LED               | <b>CREE CXB1507</b>         |                  |                       |
| LES / LED Size    | Φ 9 mm                      |                  |                       |
| FWHM (D50)        | 59°                         |                  |                       |
| Field Angle (D10) | 100°                        |                  |                       |
| H (distance)      | 2.5mm                       |                  |                       |
| Dimension         | Φ =45 mm, Thickness=20.9 mm |                  |                       |
| Luminous Flux     | 786 lm                      | Measured @ 7.1 W |                       |
| Material          | PC / UL94V2                 |                  |                       |

## cd/klm

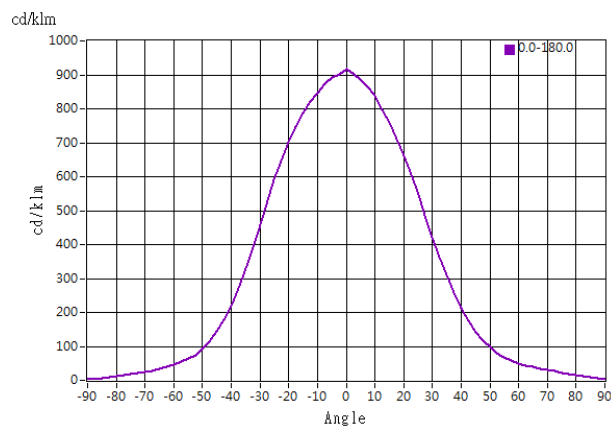

## Illuminance At Distances

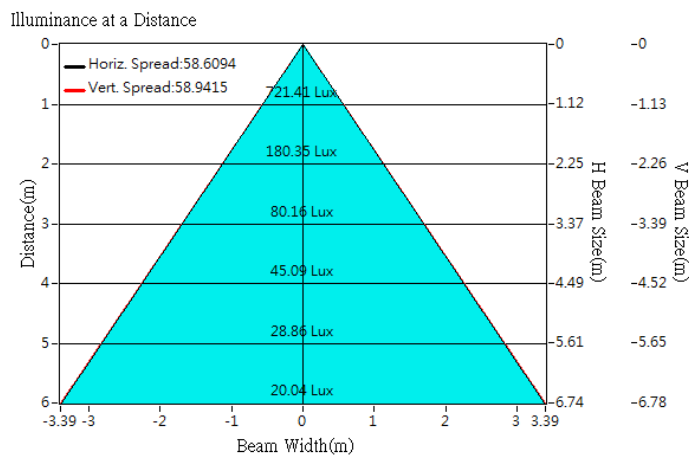



## Optical Characteristics

|                   |                             |                       |
|-------------------|-----------------------------|-----------------------|
| Model Number      | CKO-CH15-045021-1660        | <p>"H" definition</p> |
| LED               | <b>CREE CXA1510</b>         |                       |
| LES / LED Size    | Φ 9 mm                      |                       |
| FWHM (D50)        | 63°                         |                       |
| Field Angle (D10) | 104°                        |                       |
| H (distance)      | 2.5mm                       |                       |
| Dimension         | Φ =45 mm, Thickness=20.9 mm |                       |
| Luminous Flux     | 941 lm      Measured @ 9 W  |                       |
| Material          | PC / UL94V2                 |                       |

## cd/klm

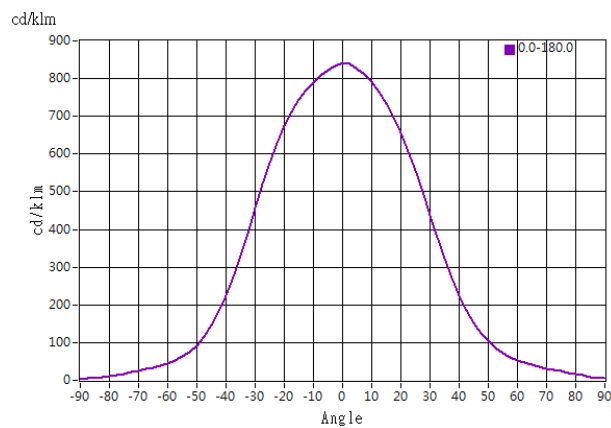

## Illuminance At Distances

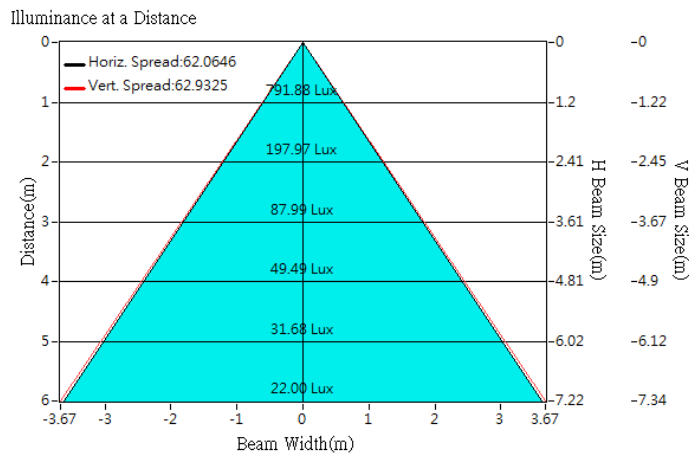



## Optical Characteristics

|                   |                             |                   |                       |
|-------------------|-----------------------------|-------------------|-----------------------|
| Model Number      | CKO-CH15-045021-1660        |                   | <p>"H" definition</p> |
| LED               | <b>CREE CXB1512</b>         |                   |                       |
| LES / LED Size    | Φ 9 mm                      |                   |                       |
| FWHM (D50)        | 59°                         |                   |                       |
| Field Angle (D10) | 101°                        |                   |                       |
| H (distance)      | 2.5mm                       |                   |                       |
| Dimension         | Φ =45 mm, Thickness=20.9 mm |                   |                       |
| Luminous Flux     | 1283 lm                     | Measured @ 12.1 W |                       |
| Material          | PC / UL94V2                 |                   |                       |

## cd/klm

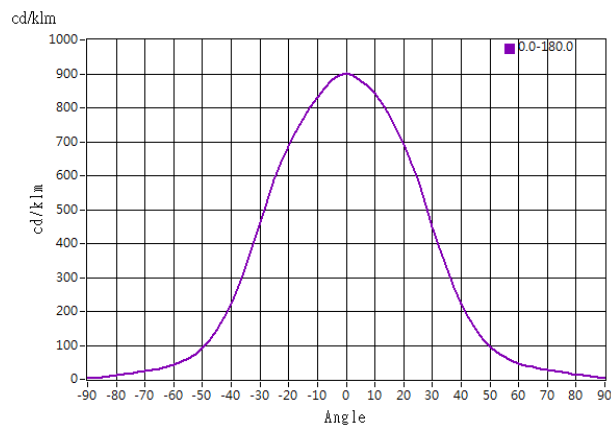

## Illuminance At Distances

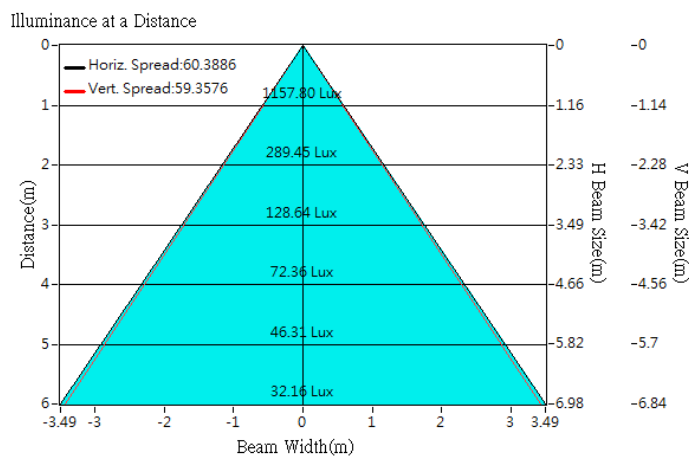



## Optical Characteristics

|                   |                             |                       |
|-------------------|-----------------------------|-----------------------|
| Model Number      | CKO-CH15-045021-1660        | <p>"H" definition</p> |
| LED               | <b>CREE CMA 1516</b>        |                       |
| LES / LED Size    | Φ 9 mm                      |                       |
| FWHM (D50)        | 55°                         |                       |
| Field Angle (D10) | 91°                         |                       |
| H (distance)      | 2.5mm                       |                       |
| Dimension         | Φ =45 mm, Thickness=20.9 mm |                       |
| Luminous Flux     | 1855 lm                     |                       |
| Material          | PC / UL94V2                 |                       |

## cd/klm

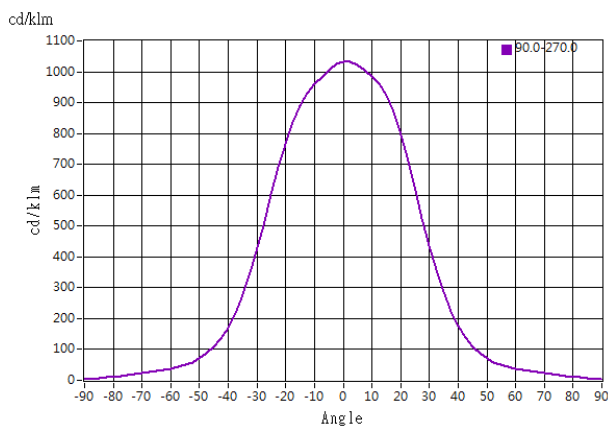

## Illuminance At Distances

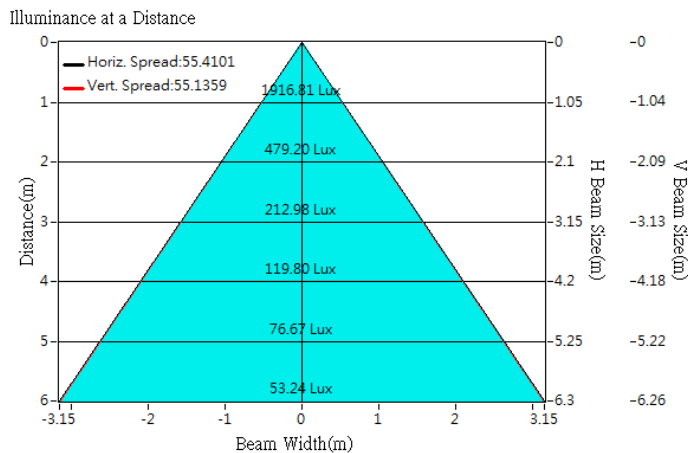



## Optical Characteristics

|                   |                             |  |
|-------------------|-----------------------------|--|
| Model Number      | CKO-CH15-045021-1660        | <p>"H" definition</p> <p>LES<br/>CoB</p> |
| LED               | <b>CREE CXB1520</b>         |  |
| LES / LED Size    | Φ 9 mm                      |  |
| FWHM (D50)        | 60°                         |  |
| Field Angle (D10) | 103°                        |  |
| H (distance)      | 2.5mm                       |  |
| Dimension         | Φ =45 mm, Thickness=20.9 mm |  |
| Luminous Flux     | 1908 lm                     |  |
| Material          | PC / UL94V2                 |  |

## cd/klm

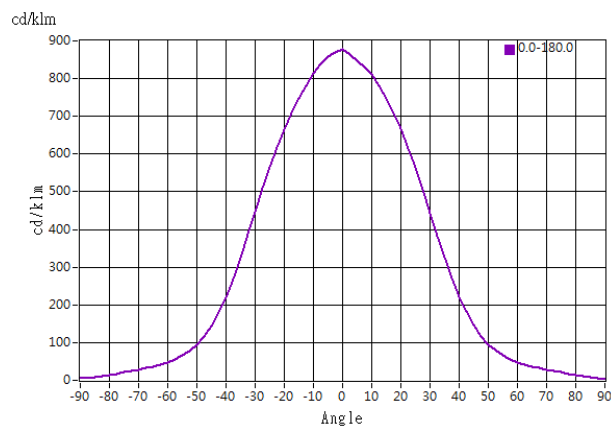

## Illuminance At Distances

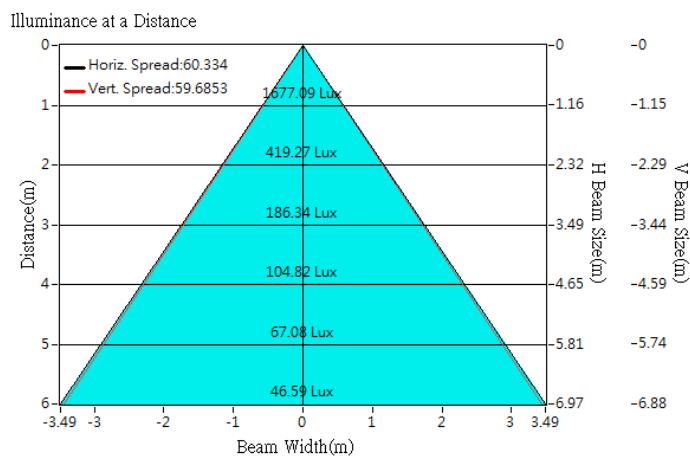



## Optical Characteristics

|                   |                             |                |                       |
|-------------------|-----------------------------|----------------|-----------------------|
| Model Number      | CKO-CH15-045021-1660        |                | <p>"H" definition</p> |
| LED               | <b>CMT1407</b>              |                |                       |
| LES / LED Size    | Φ 9.8 mm                    |                |                       |
| FWHM (D50)        | 58°                         |                |                       |
| Field Angle (D10) | 101°                        |                |                       |
| H (distance)      | 2.5mm                       |                |                       |
| Dimension         | Φ =45 mm, Thickness=20.9 mm |                |                       |
| Luminous Flux     | 832 lm                      | Measured @ 7 W |                       |
| Material          | PC / UL94V2                 |                |                       |

## cd/klm

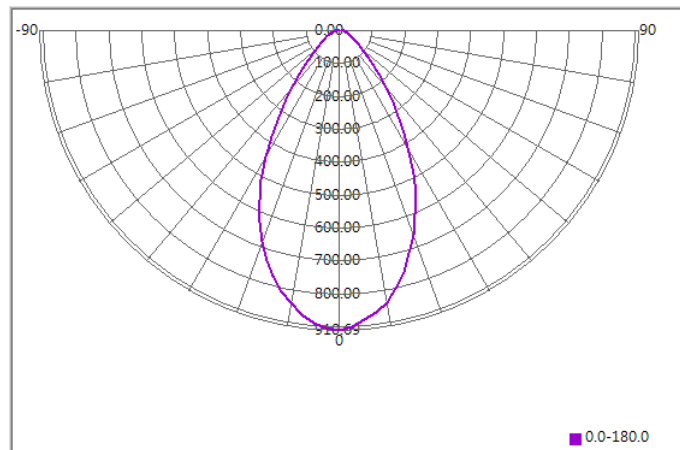

## Illuminance At Distances

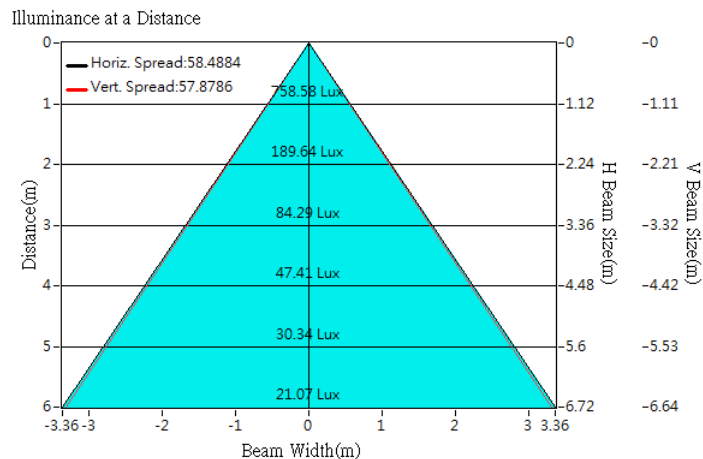



## Optical Characteristics

|                   |                             |                       |
|-------------------|-----------------------------|-----------------------|
| Model Number      | CKO-CH15-045021-1660        | <p>"H" definition</p> |
| LED               | <b>CMT1412</b>              |                       |
| LES / LED Size    | Φ 9.8 mm                    |                       |
| FWHM (D50)        | 57°                         |                       |
| Field Angle (D10) | 100°                        |                       |
| H (distance)      | 2.5mm                       |                       |
| Dimension         | Φ =45 mm, Thickness=20.9 mm |                       |
| Luminous Flux     | 1354 lm                     |                       |
| Material          | PC / UL94V2                 |                       |

## cd/klm

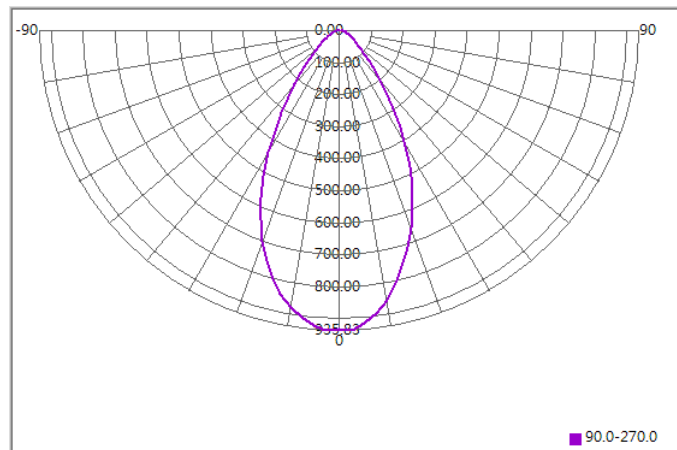

## Illuminance At Distances

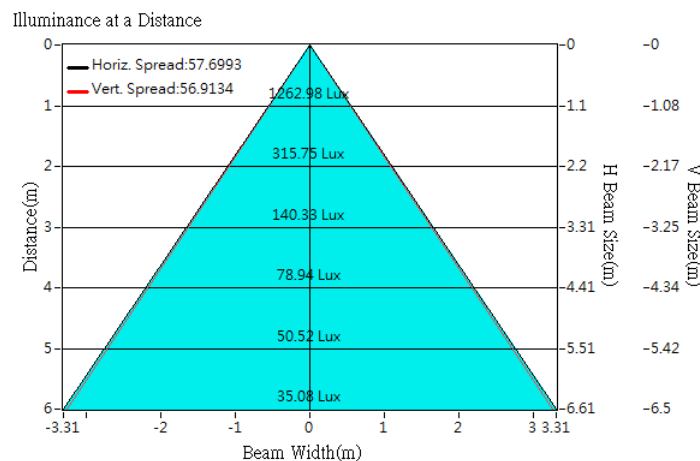



## Optical Characteristics

|                   |                             |                   |  |
|-------------------|-----------------------------|-------------------|--|
| Model Number      | CKO-CH15-045021-1660        |                   | <p>"H" definition</p> <p>LES<br/>CoB</p> |
| LED               | <b>CMT1420</b>              |                   |  |
| LES / LED Size    | Φ 9.8 mm                    |                   |  |
| FWHM (D50)        | 58°                         |                   |  |
| Field Angle (D10) | 100°                        |                   |  |
| H (distance)      | 2.5mm                       |                   |  |
| Dimension         | Φ =45 mm, Thickness=20.9 mm |                   |  |
| Luminous Flux     | 2063 lm                     | Measured @ 18.9 W |  |
| Material          | PC / UL94V2                 |                   |  |

## cd/klm

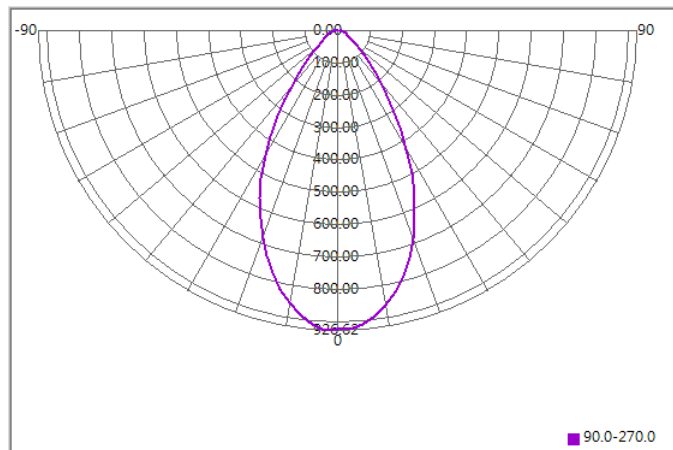

## Illuminance At Distances

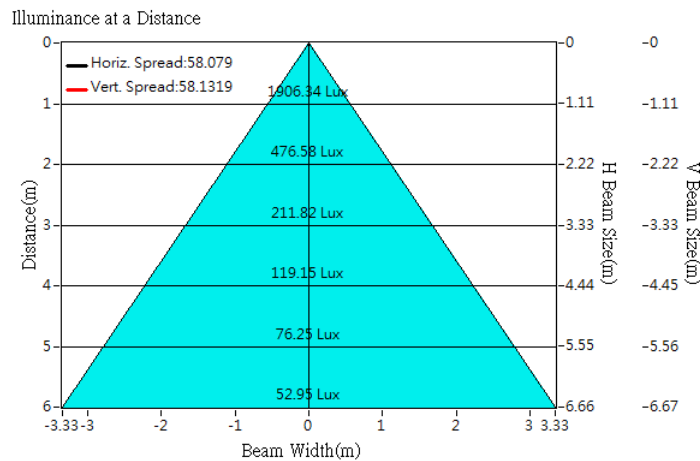



## Optical Characteristics

|                   |                             |                       |
|-------------------|-----------------------------|-----------------------|
| Model Number      | CKO-CH15-045021-1660        | <p>"H" definition</p> |
| LED               | <b>CREE CXA1816</b>         |                       |
| LES / LED Size    | Φ 12 mm                     |                       |
| FWHM (D50)        | 61°                         |                       |
| Field Angle (D10) | 105°                        |                       |
| H (distance)      | 2.5mm                       |                       |
| Dimension         | Φ =45 mm, Thickness=20.9 mm |                       |
| Luminous Flux     | 1105 lm                     |                       |
| Material          | PC / UL94V2                 |                       |

## cd/klm

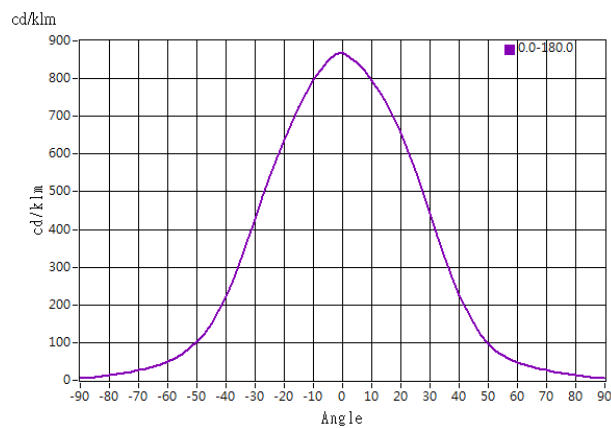

## Illuminance At Distances

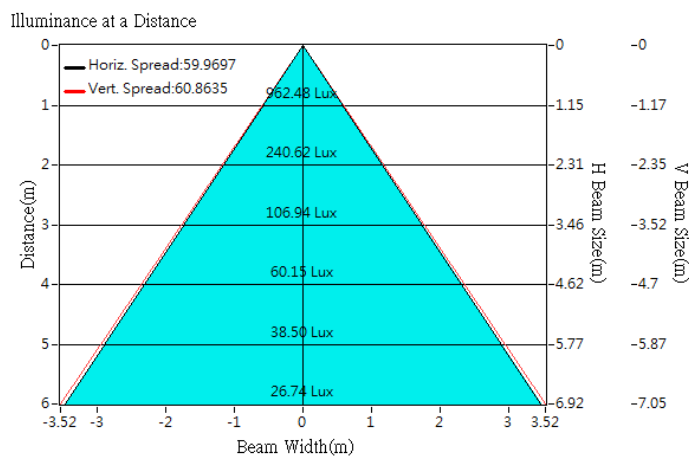



## Optical Characteristics

|                   |                             |                   |                       |
|-------------------|-----------------------------|-------------------|-----------------------|
| Model Number      | CKO-CH15-045021-1660        |                   | <p>"H" definition</p> |
| LED               | <b>CREE CXB1816</b>         |                   |                       |
| LES / LED Size    | Φ 12 mm                     |                   |                       |
| FWHM (D50)        | 59°                         |                   |                       |
| Field Angle (D10) | 103°                        |                   |                       |
| H (distance)      | 2.5mm                       |                   |                       |
| Dimension         | Φ =45 mm, Thickness=20.9 mm |                   |                       |
| Luminous Flux     | 1704 lm                     | Measured @ 15.6 W |                       |
| Material          | PC / UL94V2                 |                   |                       |

## cd/klm

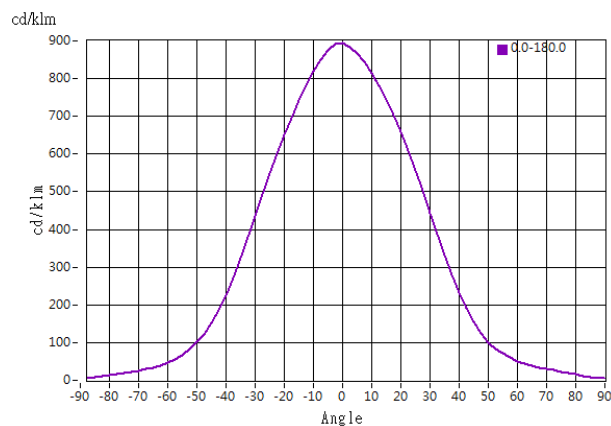

## Illuminance At Distances

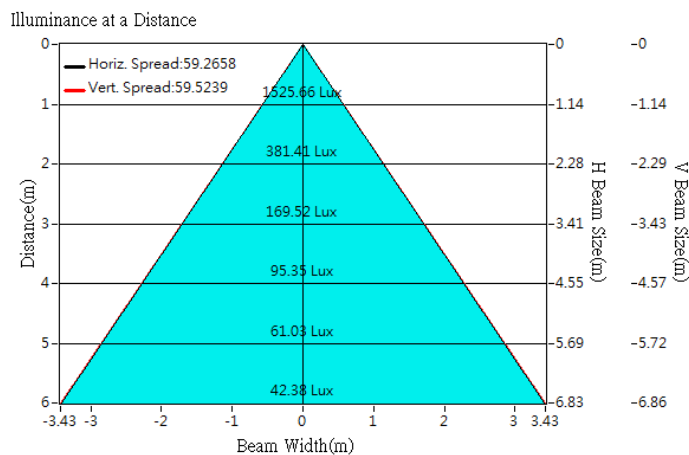



## Optical Characteristics

|                   |                             |                   |                       |
|-------------------|-----------------------------|-------------------|-----------------------|
| Model Number      | CKO-CH15-045021-1660        |                   | <p>"H" definition</p> |
| LED               | <b>CREE CXA1820</b>         |                   |                       |
| LES / LED Size    | Φ 12 mm                     |                   |                       |
| FWHM (D50)        | 61°                         |                   |                       |
| Field Angle (D10) | 106°                        |                   |                       |
| H (distance)      | 2.5mm                       |                   |                       |
| Dimension         | Φ =45 mm, Thickness=20.9 mm |                   |                       |
| Luminous Flux     | 1688 lm                     | Measured @ 19.5 W |                       |
| Material          | PC / UL94V2                 |                   |                       |

## cd/klm

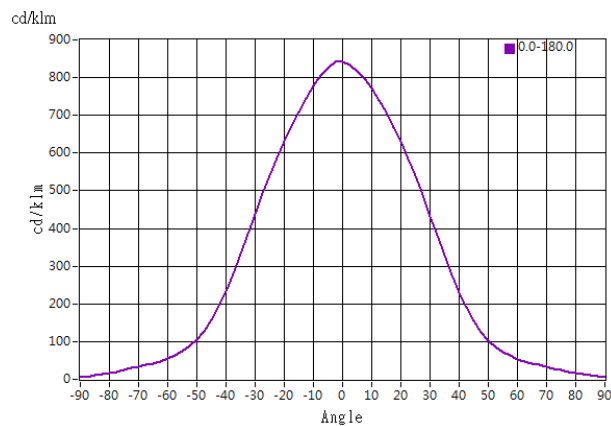

## Illuminance At Distances

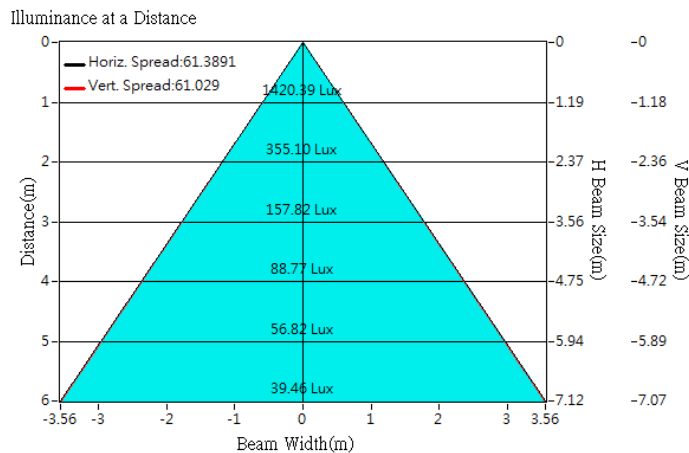



## Optical Characteristics

|                   |                             |                   |                       |
|-------------------|-----------------------------|-------------------|-----------------------|
| Model Number      | CKO-CH15-045021-1660        |                   | <p>"H" definition</p> |
| LED               | <b>CREE CXB1820</b>         |                   |                       |
| LES / LED Size    | Φ 12 mm                     |                   |                       |
| FWHM (D50)        | 60°                         |                   |                       |
| Field Angle (D10) | 104°                        |                   |                       |
| H (distance)      | 2.5mm                       |                   |                       |
| Dimension         | Φ =45 mm, Thickness=20.9 mm |                   |                       |
| Luminous Flux     | 2256 lm                     | Measured @ 19.5 W |                       |
| Material          | PC / UL94V2                 |                   |                       |

## cd/klm

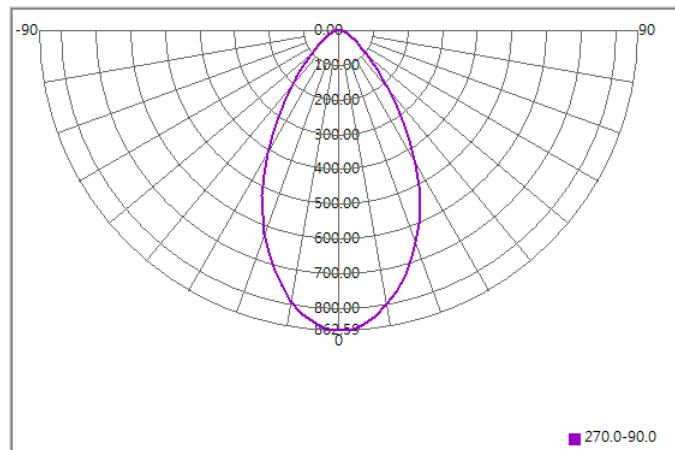

## Illuminance At Distances

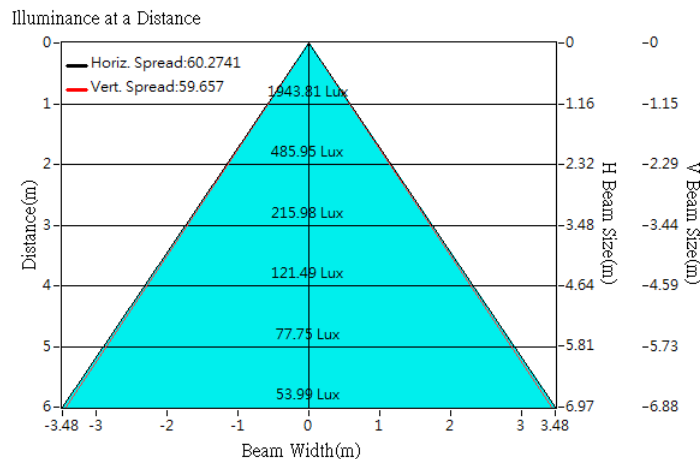



## Optical Characteristics

|                   |                             |                   |                       |
|-------------------|-----------------------------|-------------------|-----------------------|
| Model Number      | CKO-CH15-045021-1660        |                   | <p>"H" definition</p> |
| LED               | <b>CREE CMA1825</b>         |                   |                       |
| LES / LED Size    | Φ 12 mm                     |                   |                       |
| FWHM (D50)        | 58°                         |                   |                       |
| Field Angle (D10) | 103°                        |                   |                       |
| H (distance)      | 2.5mm                       |                   |                       |
| Dimension         | Φ =45 mm, Thickness=20.9 mm |                   |                       |
| Luminous Flux     | 2847lm                      | Measured @ 24.4 W |                       |
| Material          | PC / UL94V2                 |                   |                       |

## cd/klm

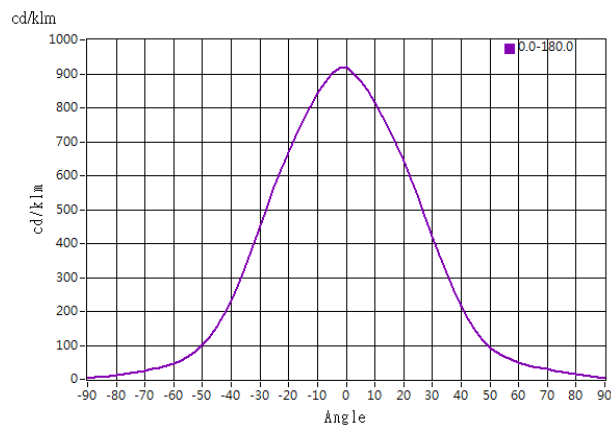

## Illuminance At Distances

