



Product Model Number

CKO-CH15-045021-1660

✓ Model Number Definitions

CKO-XXXX-XXXXXX-XXXX



- A. Chun Kuang Optics Corp. Product
- B. Product Type: product abbreviation
Ex:
CH→CoB High Intensity
CC→CoB Compact
CS→Soft Shading for CoB LED
HC→Holder for CoB LED

- C. Identity Code
- D. Lens / Fixture Size
Ex: 075026=Φ75mm / Thickness=26mm (round up)
- C. Serial Numbers

The lens datasheet is applicable for **Luminus LED**, that manufactured by Chun Kuang Optics Corp.

✓ Dimensions (mm) : Φ45 x 20.9

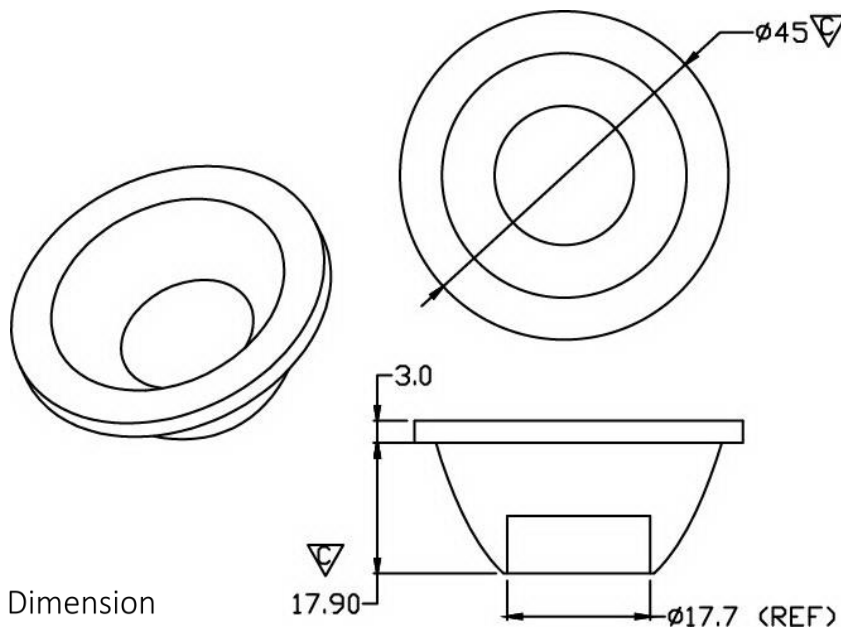

▽:Critical Dimension



Optical Characteristics

Model Number	CKO-CH15-045021-1660		<p>"H" definition</p>
LED	CXM-3-AC40		
LES / LED Size	Φ 3.5 mm		
FWHM (D50)	55°		
Field Angle (D10)	98°		
H (distance)	2.5mm		
Dimension	Φ =45 mm, Thickness=20.9 mm		
Luminous Flux	272 lm	Measured @ 2.8 W	
Material	PC / UL94V2		

cd/klm

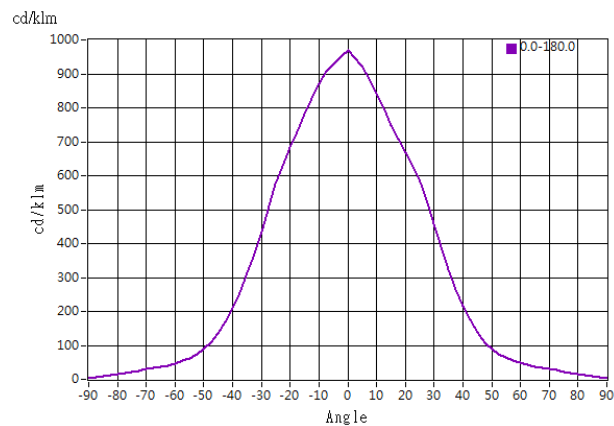

Illuminance At Distances

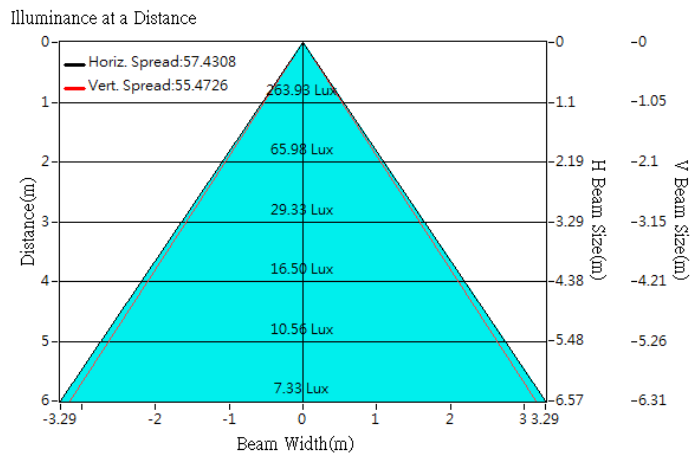



Optical Characteristics

Model Number	CKO-CH15-045021-1660		<p>"H" definition</p>
LED	CXM-4-AC40		
LES / LED Size	Φ 4.5 mm		
FWHM (D50)	59°		
Field Angle (D10)	101°		
H (distance)	2.5mm		
Dimension	Φ =45 mm, Thickness=20.9 mm		
Luminous Flux	422 lm	Measured @ 4.0 W	
Material	PC / UL94V2		

cd/klm

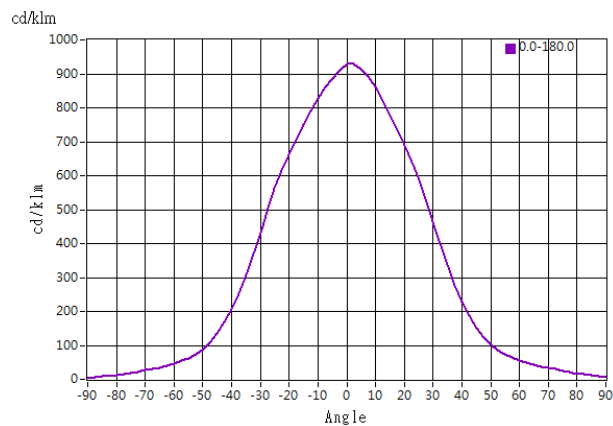

Illuminance At Distances

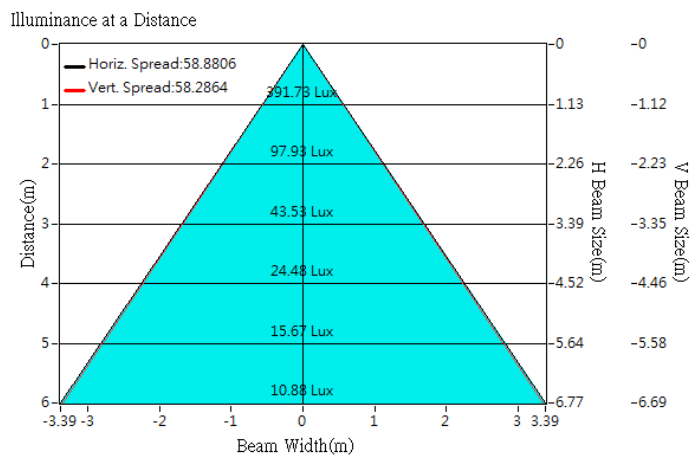



Optical Characteristics

Model Number	CKO-CH15-045021-1660		<p>"H" definition</p>
LED	CXM-6-AC40		
LES / LED Size	Φ 6.3 mm		
FWHM (D50)	56°		
Field Angle (D10)	97°		
H (distance)	2.5mm		
Dimension	Φ =45 mm, Thickness=20.9 mm		
Luminous Flux	688 lm	Measured @ 5.5 W	
Material	PC / UL94V2		

cd/klm

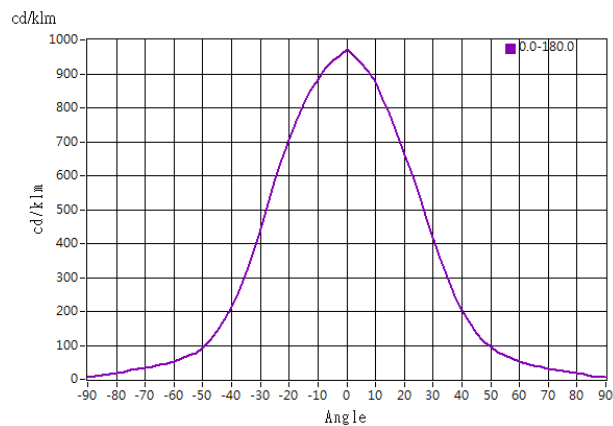

Illuminance At Distances

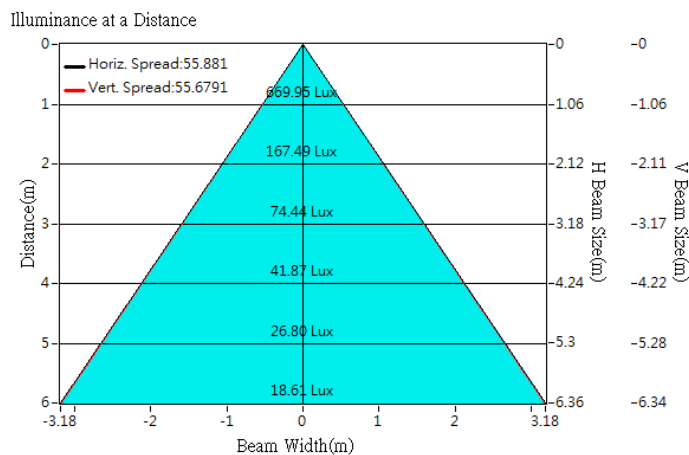



Optical Characteristics

Model Number	CKO-CH15-045021-1660		<p>"H" definition</p>
LED	CXM-9-AC30		
LES / LED Size	Φ 9.6 mm		
FWHM (D50)	58°		
Field Angle (D10)	102°		
H (distance)	2.5mm		
Dimension	Φ =45 mm, Thickness=20.9 mm		
Luminous Flux	1255 lm	Measured @ 12.1 W	
Material	PC / UL94V2		

cd/klm

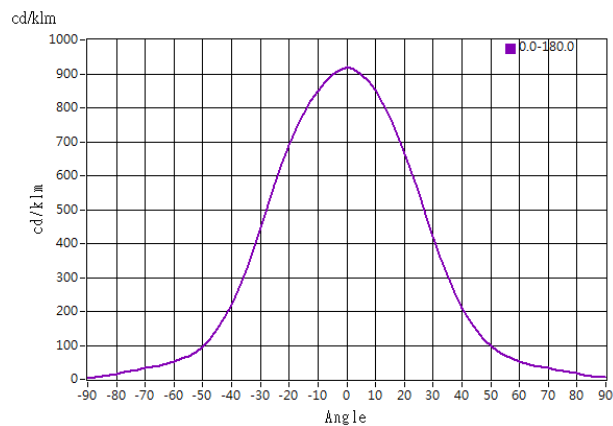

Illuminance At Distances

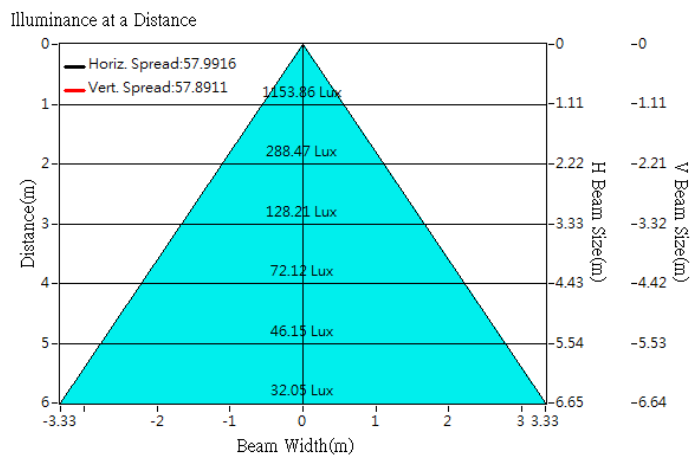



Optical Characteristics

Model Number	CKO-CH15-045021-1660		<p>"H" definition</p>
LED	CXM-9-AC40		
LES / LED Size	Φ 9.8 mm		
FWHM (D50)	59°		
Field Angle (D10)	103°		
H (distance)	2.5mm		
Dimension	Φ =45 mm, Thickness=20.9 mm		
Luminous Flux	1246 lm	Measured @ 12.3 W	
Material	PC / UL94V2		

cd/klm

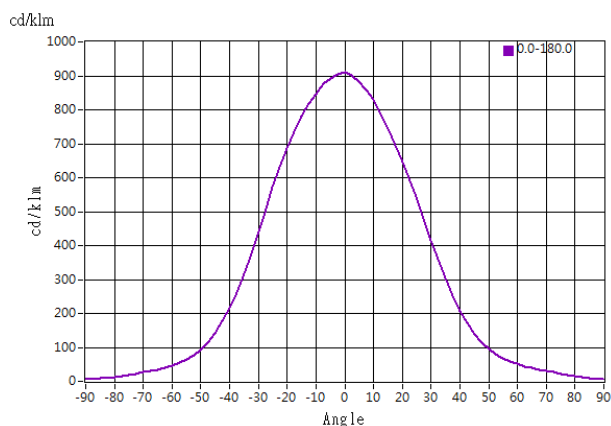

Illuminance At Distances

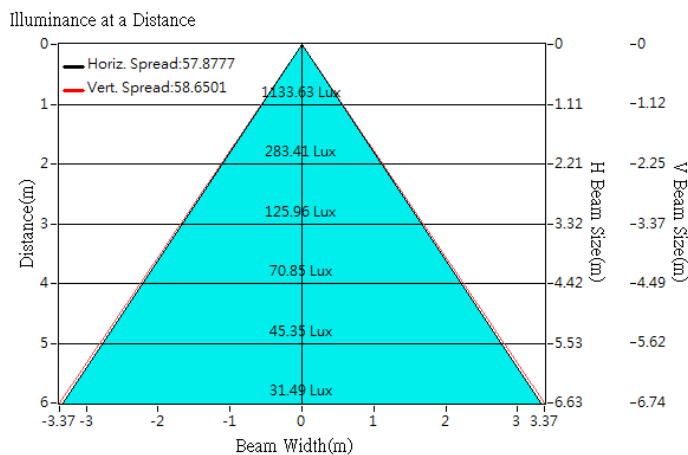



Optical Characteristics

Model Number	CKO-CH15-045021-1660	<p>"H" definition</p>
LED	CXM-11-AC30	
LES / LED Size	Φ 11.7 mm	
FWHM (D50)	58°	
Field Angle (D10)	102°	
H (distance)	2.5mm	
Dimension	Φ =45 mm, Thickness=20.9 mm	
Luminous Flux	1508 lm	
Material	PC / UL94V2	

cd/klm

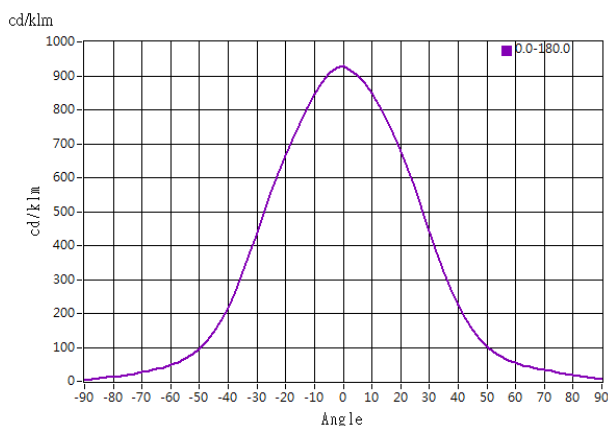

Illuminance At Distances

