



Product Model Number

CKO-CH15-060027-4301

✓ Model Number Definitions

CKO-XXXX-XXXXXX-XXXX



- A. Chun Kuang Optics Corp. Product
- B. Product Type: product abbreviation
Ex:
CH→CoB High Intensity
CC→CoB Compact
CS→Soft Shading for CoB LED
HC→Holder for CoB LED

- C. Identity Code
- D. Lens / Fixture Size
Ex: 075026=Φ75mm / Thickness=26mm (round up)
- C. Serial Numbers

The lens datasheet is applicable for **Luminus LED**, that manufactured by Chun Kuang Optics Corp.

✓ Dimensions (mm) : Φ60 x 26.85

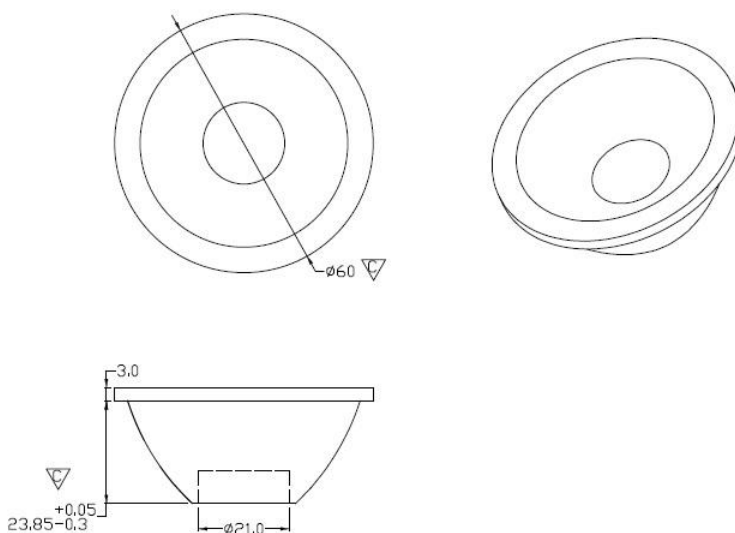

▽:Critical Dimension



Optical Characteristics

Model Number	CKO-CH15-060027-4301		<p>"H" definition</p> <p>LES CoB</p>
LED	CXM-9-AC30		
LES / LED Size	Φ 9.6 mm		
FWHM (D50)	16°		
Field Angle (D10)	35°		
H (distance)	3.65mm		
Dimension	Φ =60 mm, Thickness=26.85 mm		
Luminous Flux	1374 lm	Measured @ 12.11 W	
Material	PC / UL94V2		

cd/klm

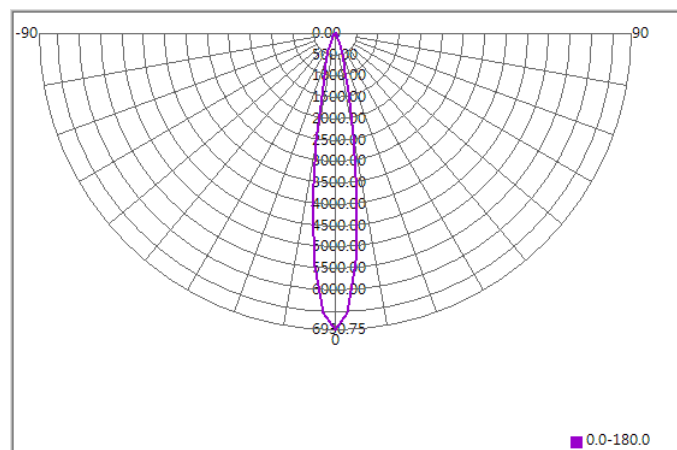

Illuminance At Distances

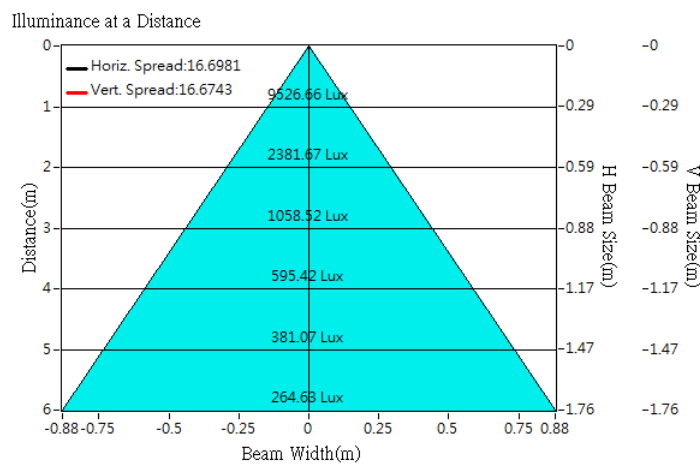



Optical Characteristics

Model Number	CKO-CH15-060027-4301	<p>"H" definition</p> <p>LES CoB</p>	
LED	CXM-9-AC40		
LES / LED Size	Φ 9.8 mm		
FWHM (D50)	17°		
Field Angle (D10)	37°		
H (distance)	3.65mm		
Dimension	Φ =60 mm, Thickness=26.85 mm		
Luminous Flux	1367 lm		Measured @ 12.4 W
Material	PC / UL94V2		

cd/klm

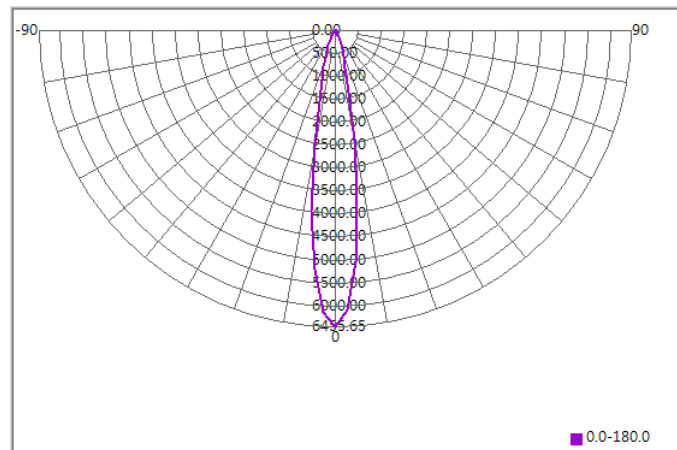

Illuminance At Distances

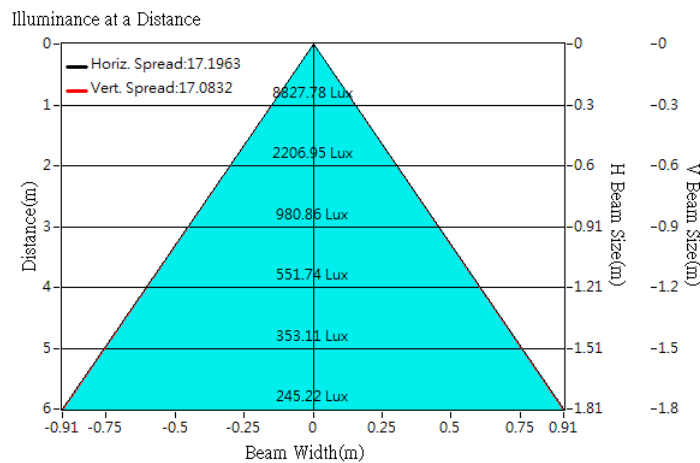



Optical Characteristics

Model Number	CKO-CH15-060027-4301		<p>"H" definition</p>
LED	CXM-11-AC30		
LES / LED Size	Φ 11.7 mm		
FWHM (D50)	19°		
Field Angle (D10)	42°		
H (distance)	3.65mm		
Dimension	Φ =60 mm, Thickness=26.85 mm		
Luminous Flux	1677 lm	Measured @ 15.7 W	
Material	PC / UL94V2		

cd/klm

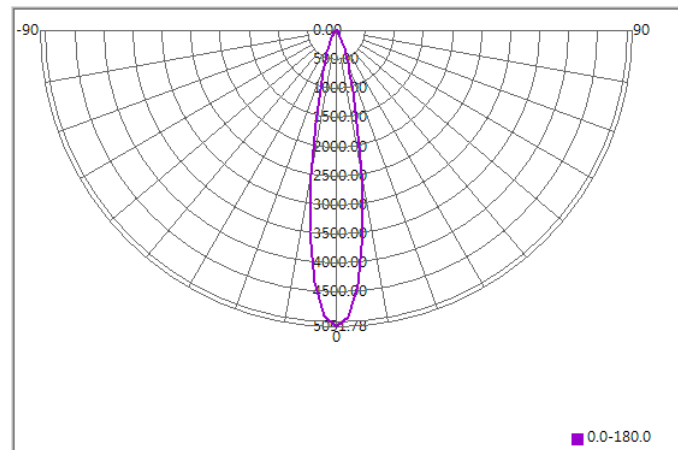

Illuminance At Distances

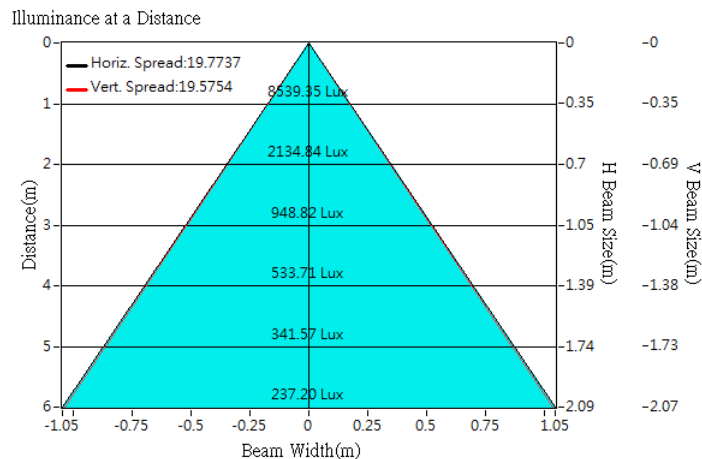



Optical Characteristics

Model Number	CKO-CH15-060027-4301		<p>"H" definition</p>
LED	CLM-14-AC40		
LES / LED Size	Φ14.5		
FWHM (D50)	25°		
Field Angle (D10)	52°		
H (distance)	3.65mm		
Dimension	Φ =60 mm, Thickness=26.85 mm		
Luminous Flux	2505 lm	Measured @ 16.6 W	
Material	PC / UL94V2		

cd/klm

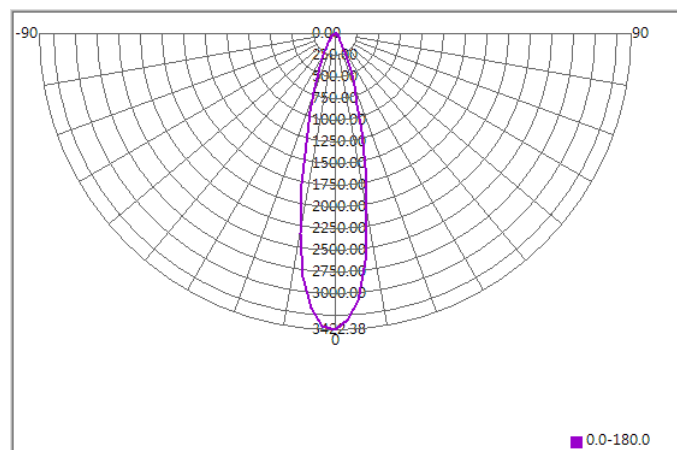

Illuminance At Distances

