



Product Model Number

CKO-CH15-060027-4304

✓ Model Number Definitions

CKO-XXXX-XXXXXX-XXXX



- A. Chun Kuang Optics Corp. Product
- B. Product Type: product abbreviation
Ex:
CH→CoB High Intensity
CC→CoB Compact
CS→Soft Shading for CoB LED
HC→Holder for CoB LED

- C. Identity Code
- D. Lens / Fixture Size
Ex: 075026=Φ75mm / Thickness=26mm (round up)
- C. Serial Numbers

The lens datasheet is applicable for **Philips LED**, that manufactured by Chun Kuang Optics Corp.

✓ Dimensions (mm) : Φ60 x 26.85

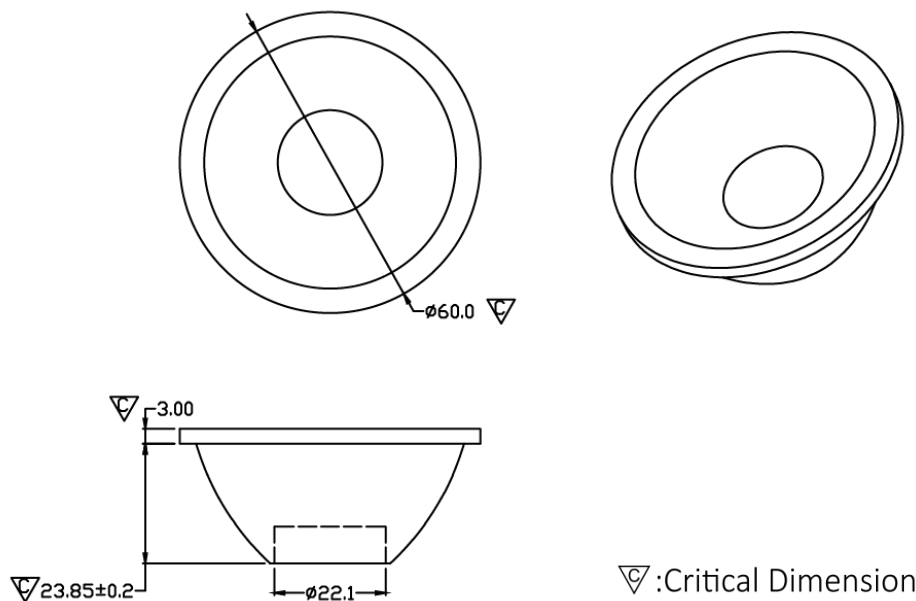



✓ Optical Characteristics – Angle Performances

Philips	LED LES (mm)	FWHM (degrees)	Field Angle (degrees)
Fortimo SLM 1201 L09 G7N	Φ9.8	29°	60°
Fortimo SLM 1202 L09 G7N	Φ9.8	30°	61°
Fortimo SLM 1203 L09 G7N	Φ9.8	29°	61°
Fortimo SLM 1204 L09 G7N	Φ9.8	29°	61°
Fortimo SLM 1205 L13 G7	Φ13	33°	68°
Fortimo SLM 1205 L15 G7N	Φ14.5	35°	70°
Fortimo SLM 1206 L15 G7N	Φ14.5	35°	71°
Fortimo SLM 1208 L15 G7N	Φ14.5	35°	71°
Fortimo SLM 1208 L15 G7	Φ15	35°	71°



Optical Characteristics

Model Number	CKO-CH15-060027-4304		<p>"H" definition</p>
LED	Fortimo SLM 1201 L09 G7N		
LES / LED Size	Φ 9.8 mm		
FWHM (D50)	29°		
Field Angle (D10)	60°		
H (distance)	3.65mm		
Dimension	Φ =60 mm, Thickness=26.85 mm		
Luminous Flux	462 lm	Measured @ 3.09 W	
Material	PC / UL94V2		

cd/klm

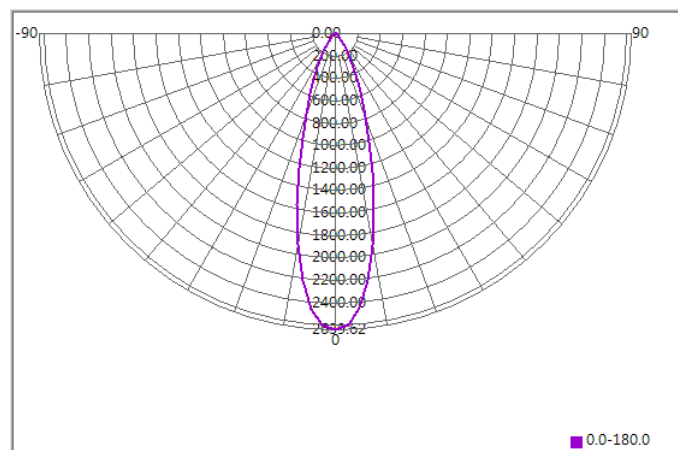

Illuminance At Distances

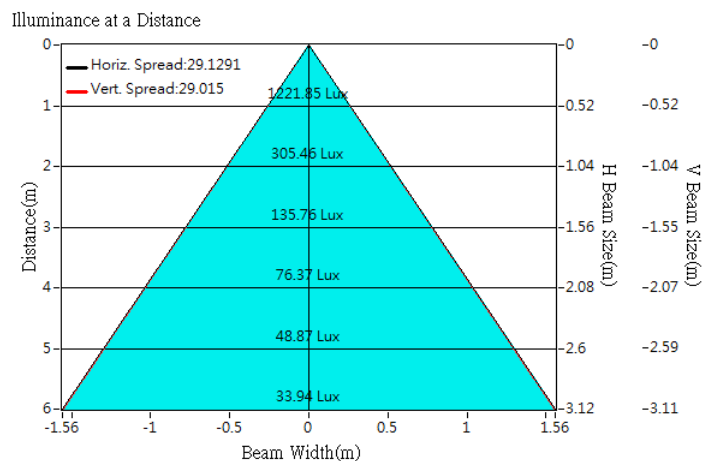



Optical Characteristics

Model Number	CKO-CH15-060027-4304		<p>"H" definition</p>
LED	Fortimo SLM 1202 L09 G7N		
LES / LED Size	Φ 9.8 mm		
FWHM (D50)	30°		
Field Angle (D10)	61°		
H (distance)	3.65mm		
Dimension	Φ =60 mm, Thickness=26.85 mm		
Luminous Flux	890 lm	Measured @ 6.1 W	
Material	PC / UL94V2		

cd/klm

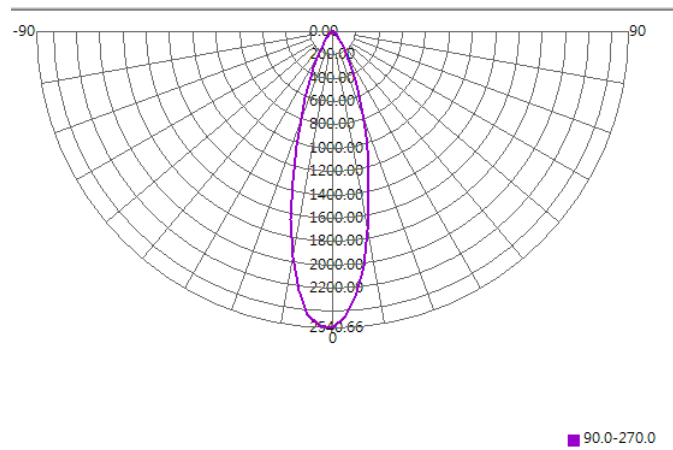

Illuminance At Distances

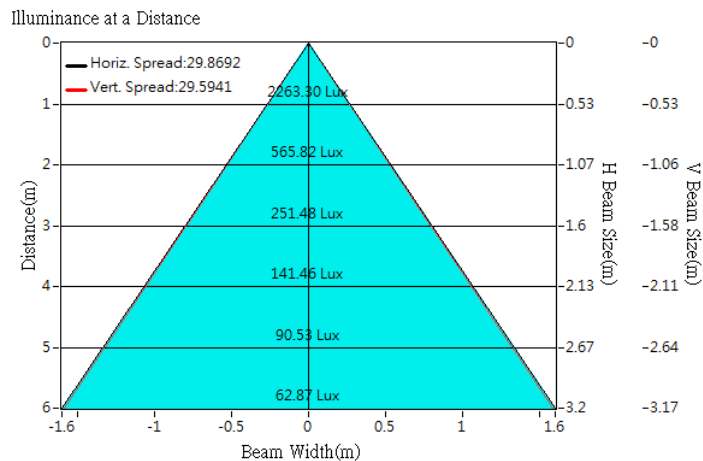



Optical Characteristics

Model Number	CKO-CH15-060027-4304		<p>"H" definition</p>
LED	Fortimo SLM 1203 L09 G7N		
LES / LED Size	Φ 9.8 mm		
FWHM (D50)	29°		
Field Angle (D10)	61°		
H (distance)	3.65mm		
Dimension	Φ =60 mm, Thickness=26.85 mm		
Luminous Flux	1324 lm	Measured @ 9.2 W	
Material	PC / UL94V2		

cd/klm

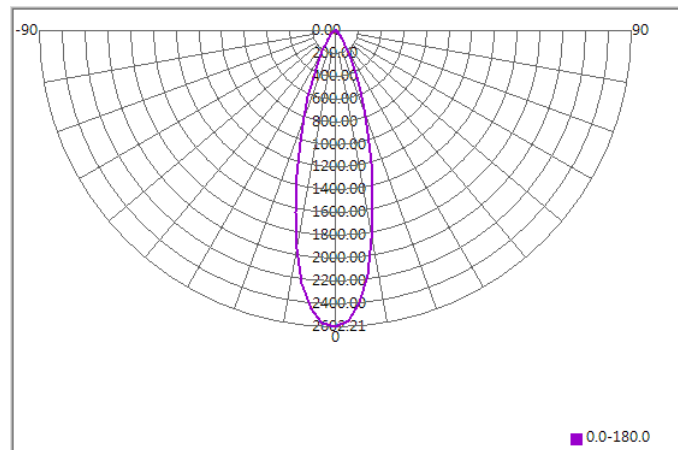

Illuminance At Distances

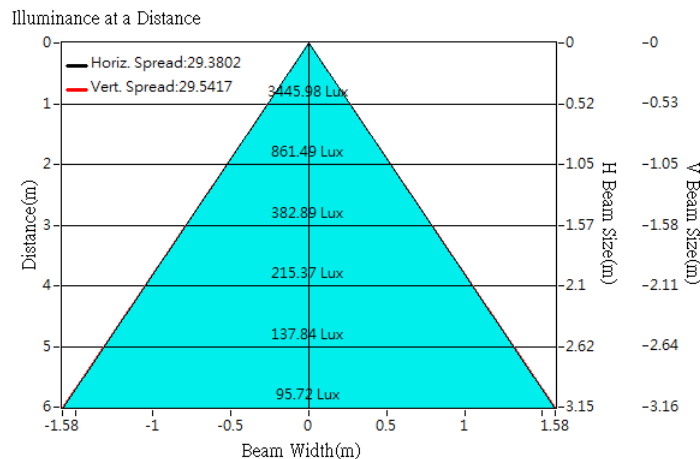

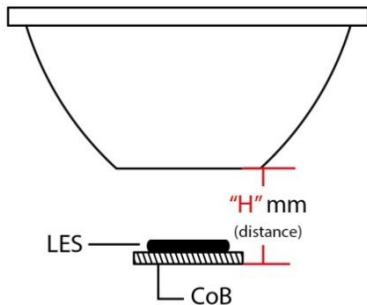

Optical Characteristics

Model Number	CKO-CH15-060027-4304		<p>"H" definition</p> 
LED	Fortimo SLM 1204 L09 G7N		
LES / LED Size	Φ 9.8 mm		
FWHM (D50)	29°		
Field Angle (D10)	61°		
H (distance)	3.65mm		
Dimension	Φ =60 mm, Thickness=26.85 mm		
Luminous Flux	1755 lm	Measured @ 12.3 W	
Material	PC / UL94V2		

cd/klm

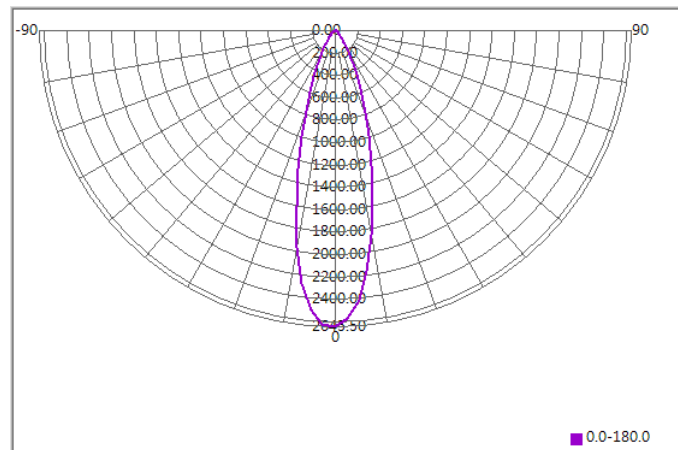

Illuminance At Distances

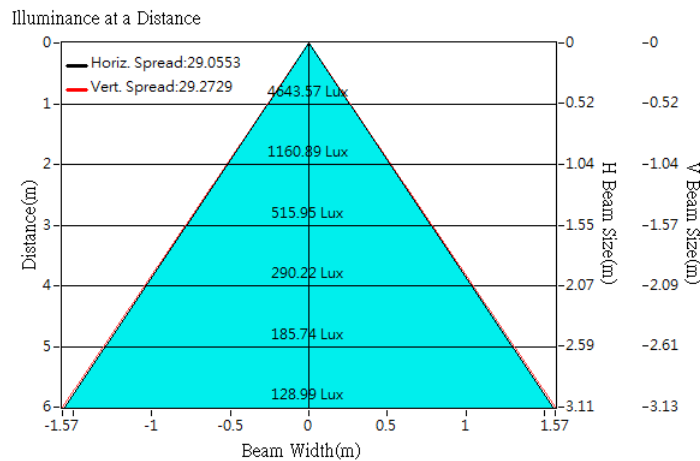



Optical Characteristics

Model Number	CKO-CH15-060027-4304		<p>"H" definition</p>
LED	Fortimo SLM 1205 L13 G7		
LES / LED Size	Φ 13 mm		
FWHM (D50)	33°		
Field Angle (D10)	68°		
H (distance)	3.65mm		
Dimension	Φ =60 mm, Thickness=26.85 mm		
Luminous Flux	1896 lm	Measured @ 17.6 W	
Material	PC / UL94V2		

cd/klm

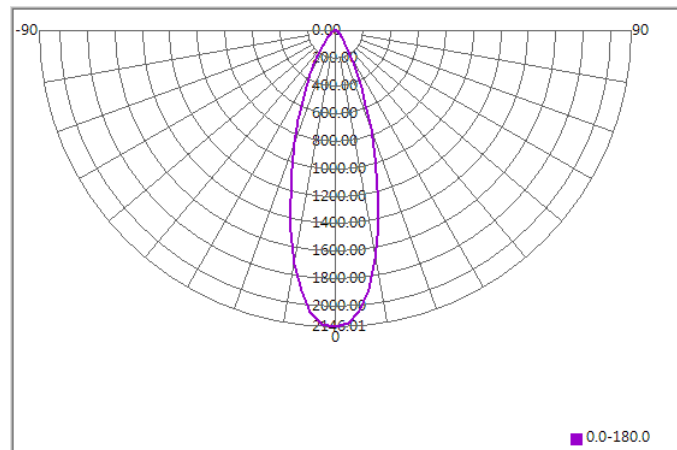

Illuminance At Distances

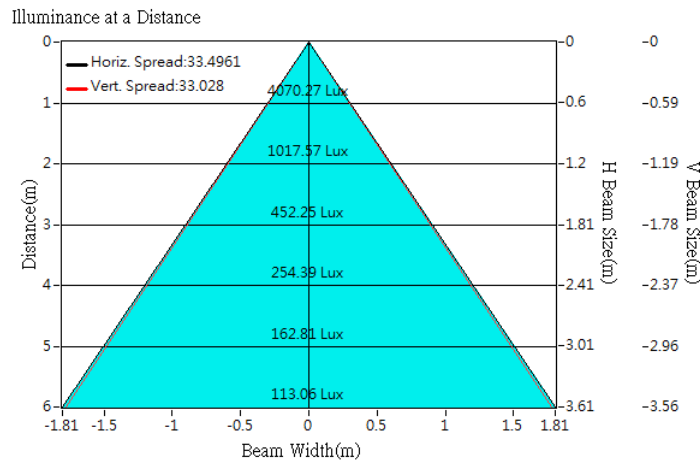

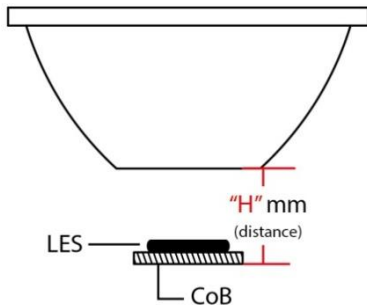

Optical Characteristics

Model Number	CKO-CH15-060027-4304		<p>"H" definition</p> 
LED	Fortimo SLM 1205 L15 G7N		
LES / LED Size	Φ 14.5 mm		
FWHM (D50)	35°		
Field Angle (D10)	70°		
H (distance)	3.65mm		
Dimension	Φ =60 mm, Thickness=26.85 mm		
Luminous Flux	2192 lm	Measured @ 15.4 W	
Material	PC / UL94V2		

cd/klm

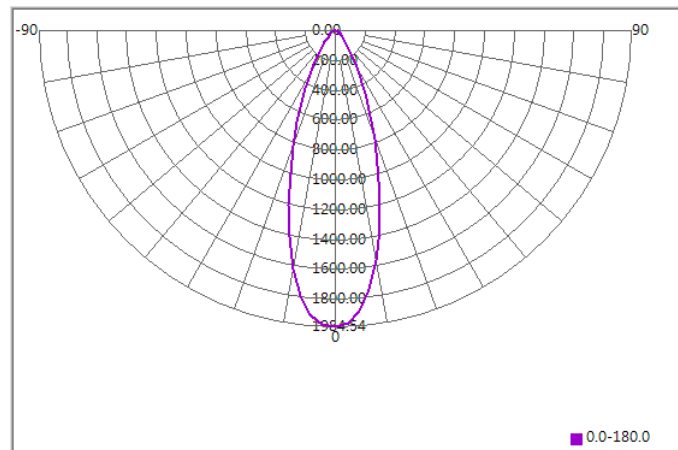

Illuminance At Distances

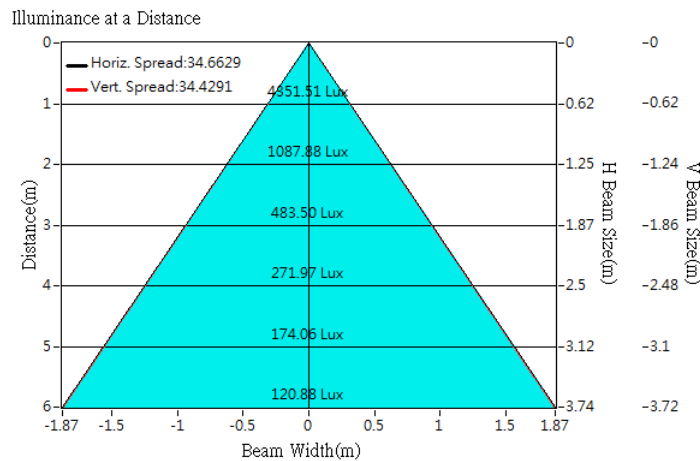

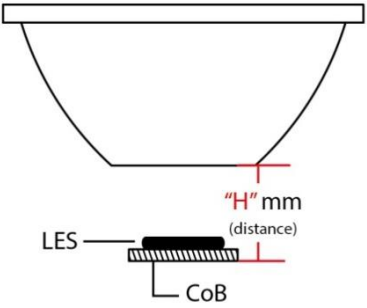

Optical Characteristics

Model Number	CKO-CH15-060027-4304		<p>"H" definition</p> 
LED	Fortimo SLM 1206 L15 G7N		
LES / LED Size	Φ 14.5 mm		
FWHM (D50)	35°		
Field Angle (D10)	71°		
H (distance)	3.65mm		
Dimension	Φ =60 mm, Thickness=26.85 mm		
Luminous Flux	2630 lm	Measured @ 18.4 W	
Material	PC / UL94V2		

cd/klm

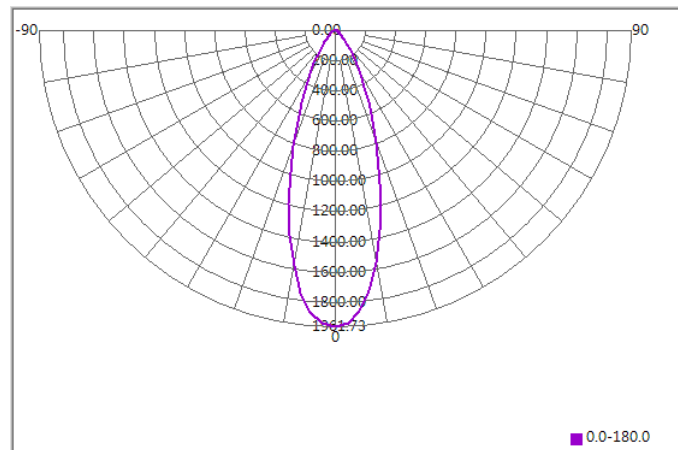

Illuminance At Distances

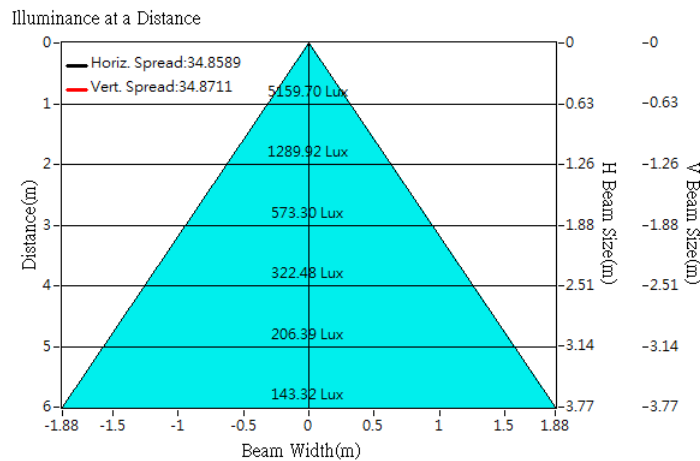



Optical Characteristics

Model Number	CKO-CH15-060027-4304		<p>"H" definition</p>
LED	Fortimo SLM 1208 L15 G7N		
LES / LED Size	Φ 14.5 mm		
FWHM (D50)	35°		
Field Angle (D10)	71°		
H (distance)	3.65mm		
Dimension	Φ =60 mm, Thickness=26.85 mm		
Luminous Flux	3665 lm	Measured @ 24.7 W	
Material	PC / UL94V2		

cd/klm

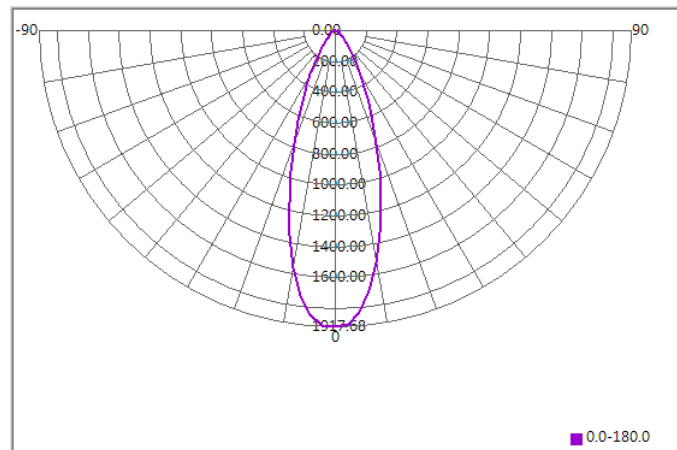

Illuminance At Distances

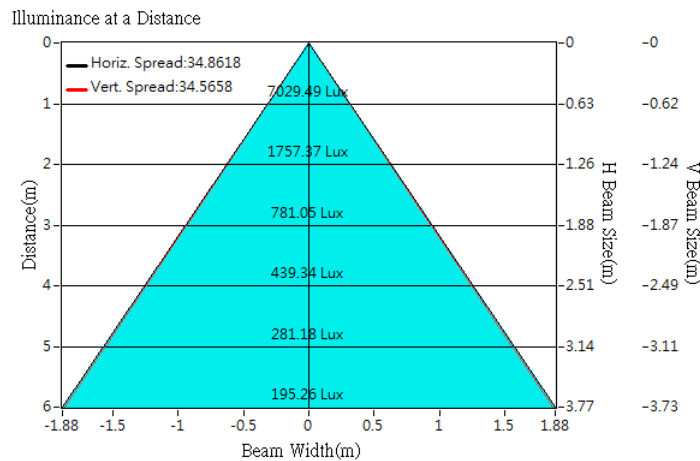



Optical Characteristics

Model Number	CKO-CH15-060027-4304	<p>"H" definition</p> <p>LES CoB</p>
LED	Fortimo SLM 1208 L15 G7	
LES / LED Size	Φ 15 mm	
FWHM (D50)	35°	
Field Angle (D10)	71°	
H (distance)	3.65mm	
Dimension	Φ =60 mm, Thickness=26.85 mm	
Luminous Flux	2935 lm	
Material	PC / UL94V2	

cd/klm

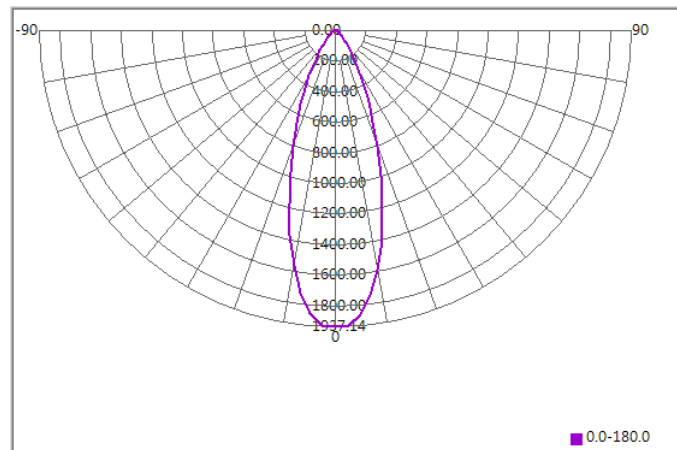

Illuminance At Distances

