



Product Model Number

CKO-CH15-060027-4305

✓ Model Number Definitions

CKO-XXXX-XXXXXX-XXXX



- A. Chun Kuang Optics Corp. Product
- B. Product Type: product abbreviation
Ex:
CH→CoB High Intensity
CC→CoB Compact
CS→Soft Shading for CoB LED
HC→Holder for CoB LED

- C. Identity Code
- D. Lens / Fixture Size
Ex: 075026=Φ75mm / Thickness=26mm (round up)
- C. Serial Numbers

The lens datasheet is applicable for **Philips LED**, that manufactured by Chun Kuang Optics Corp.

✓ Dimensions (mm) : Φ60 x 26.85

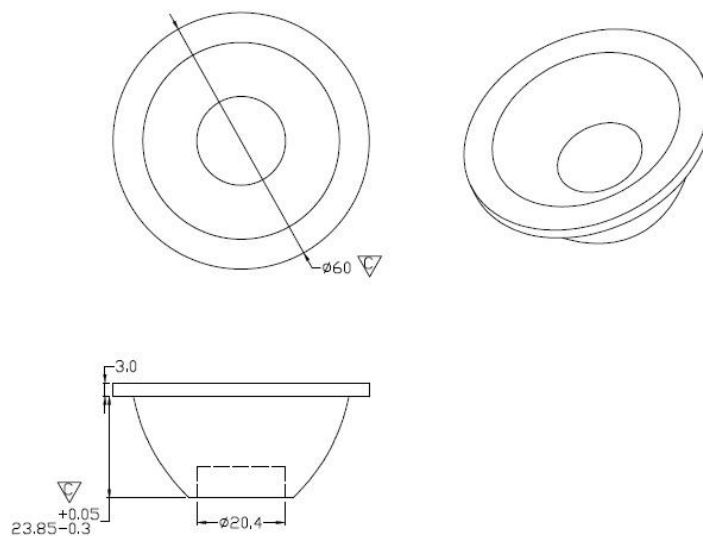

▽:Critical Dimension



✓ Optical Characteristics – Angle Performances

Philips	LED LES (mm)	FWHM (degrees)	Field Angle (degrees)
Fortimo SLM 1203 L09 G6	Φ9	33°	62°
Fortimo SLM 1203 L09 G6_DL	Φ9	36°	67°
Fortimo SLM 1203 L09 G6_PI	Φ9	36°	67°
Fortimo SLM PW 1204 L09 G7	Φ9	33°	62°
Fortimo SLM 1201 L09 G7N	Φ9.8	34°	63°
Fortimo SLM 1202 L09 G7N	Φ9.8	34°	62°
Fortimo SLM 1203 L09 G7N	Φ9.8	35°	64°
Fortimo SLM 1204 L09 G7N	Φ9.8	34°	63°
Fortimo SLM 1205 L13 G7	Φ13	39°	71°
Fortimo SLM PW 1205 L13 G6	Φ13	38°	69°
Fortimo SLM PW 1205 L13 G6_DL	Φ13	39°	70°
Fortimo SLM PW 1205 L13 G6_PI	Φ13	39°	70°
Fortimo SLM 1205 L15 G7N	Φ14.5	40°	70°
Fortimo SLM 1206 L15 G7N	Φ14.5	40°	71°
Fortimo SLM 1208 L15 G7N	Φ14.5	40°	71°
Fortimo SLM 1208 L15 G7	Φ15	41°	73°
Fortimo SLM 1208 L15 G6	Φ15	40°	71°
Fortimo SLM 1208 L15 G6_DL	Φ15	41°	73°
Fortimo SLM 1208 L15 G6_PI	Φ15	41°	73°



Optical Characteristics

Model Number	CKO-CH15-060027-4305		<p>"H" definition</p>
LED	Fortimo SLM 1203 L09 G6		
LES / LED Size	Φ 9 mm		
FWHM (D50)	33°		
Field Angle (D10)	62°		
H (distance)	3.65mm		
Dimension	Φ =60 mm, Thickness=26.85 mm		
Luminous Flux	1248 lm	Measured @ 10.4 W	
Material	PC / UL94V2		

cd/klm

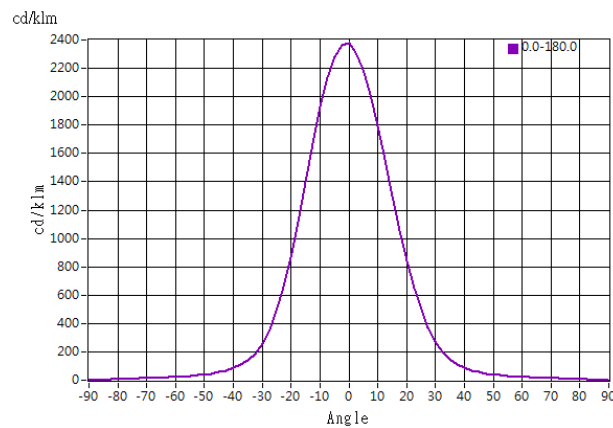

Illuminance At Distances

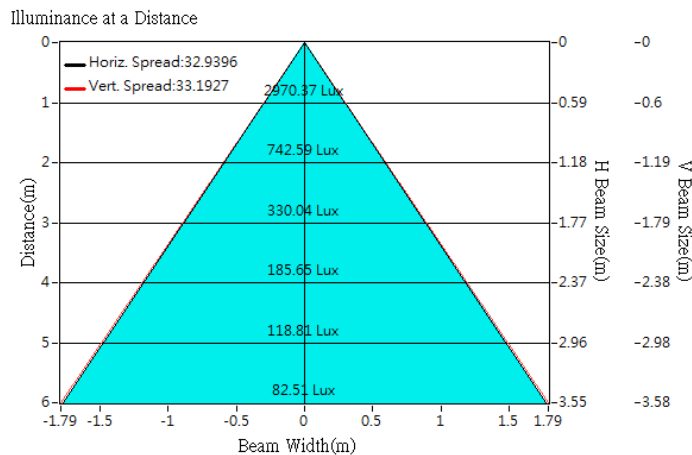



Optical Characteristics

Model Number	CKO-CH15-060027-4305		
LED	Fortimo SLM 1203 L09 G6_DL		
LES / LED Size	Φ 9 mm		
FWHM (D50)	36°		
Field Angle (D10)	67°		
H (distance)	3.5mm		
Dimension	Φ =60 mm, Thickness=26.85 mm		
Luminous Flux	1015 lm	Measured @ 10.5 W	
Material	PC / UL94V2		

cd/klm

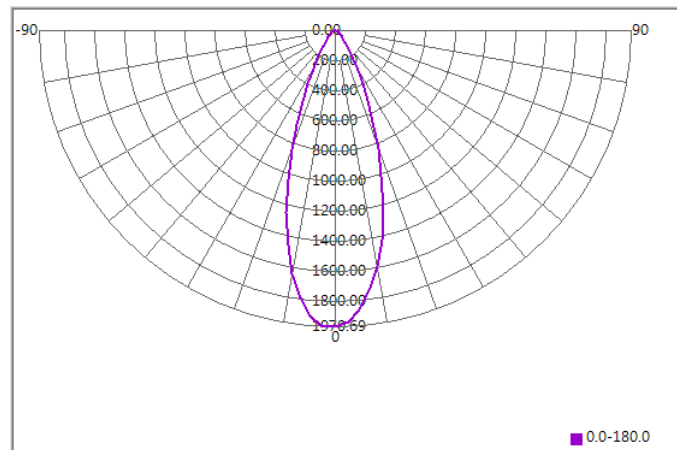

Illuminance At Distances

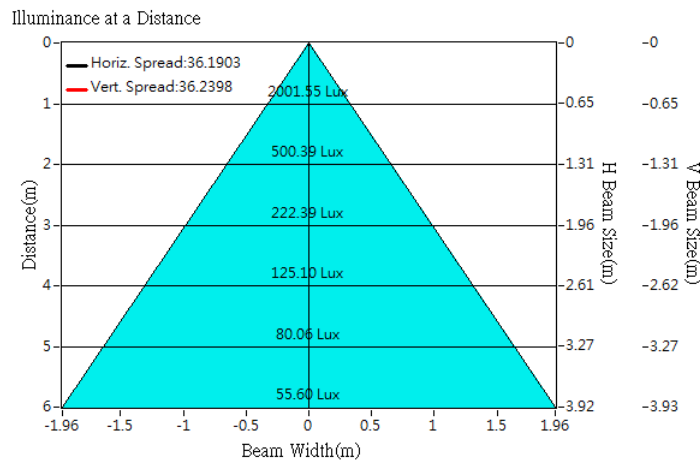



Optical Characteristics

Model Number	CKO-CH15-060027-4305		<p>"H" definition</p>
LED	Fortimo SLM 1203 L09 G6_PI		
LES / LED Size	Φ 9 mm		
FWHM (D50)	36°		
Field Angle (D10)	67°		
H (distance)	3.5mm		
Dimension	Φ =60 mm, Thickness=26.85 mm		
Luminous Flux	1015 lm	Measured @ 10.5 W	
Material	PC / UL94V2		

cd/klm

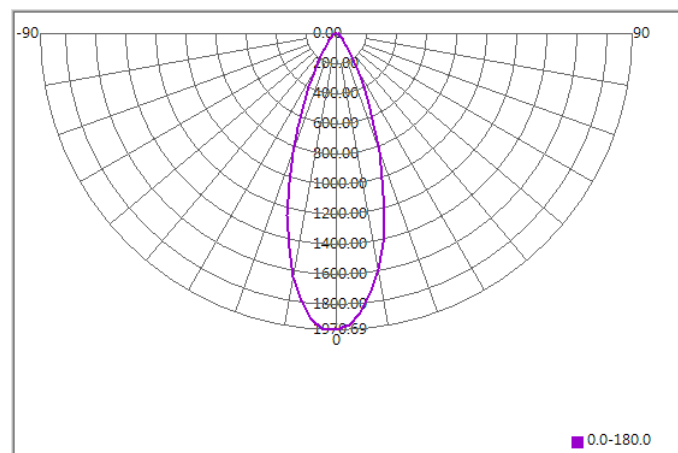

Illuminance At Distances

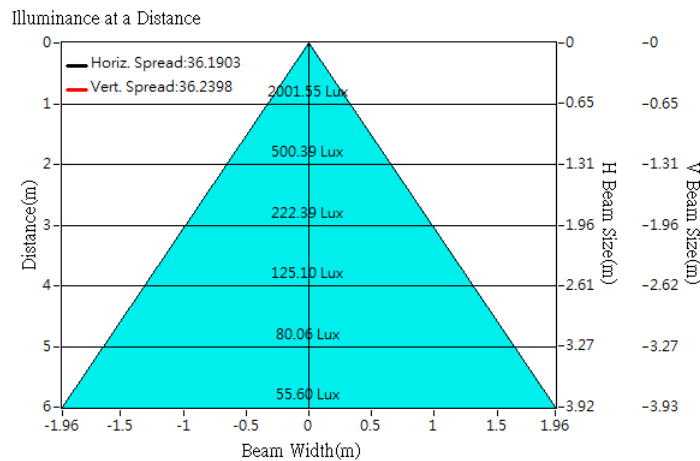

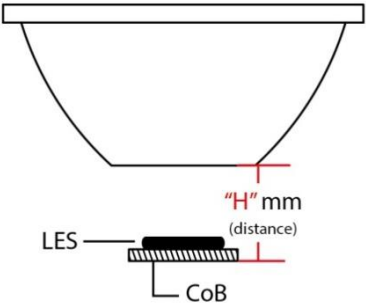

Optical Characteristics

Model Number	CKO-CH15-060027-4305		<p>"H" definition</p> 
LED	Fortimo SLM PW 1204 L09 G7		
LES / LED Size	Φ 9 mm		
FWHM (D50)	33°		
Field Angle (D10)	62°		
H (distance)	3.65mm		
Dimension	Φ =60 mm, Thickness=26.85 mm		
Luminous Flux	2013 lm	Measured @ 21.6 W	
Material	PC / UL94V2		

cd/klm

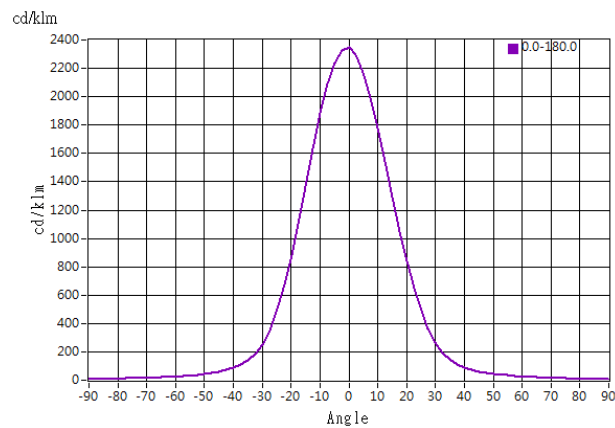

Illuminance At Distances

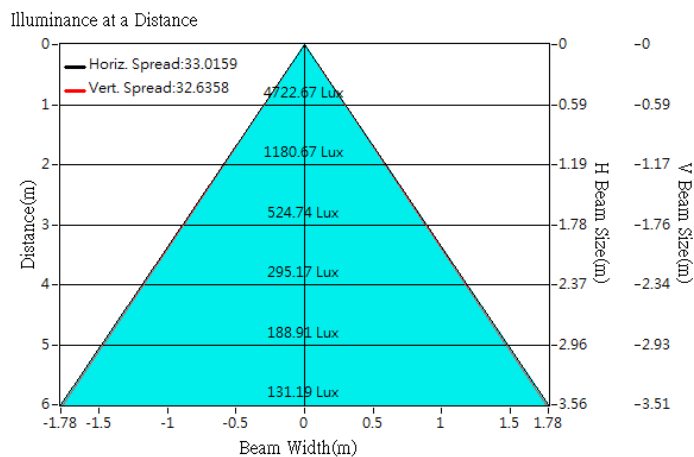



Optical Characteristics

Model Number	CKO-CH15-060027-4305		<p>"H" definition</p>
LED	Fortimo SLM 1201 L09 G7N		
LES / LED Size	Φ 9.8 mm		
FWHM (D50)	21°		
Field Angle (D10)	43°		
H (distance)	3.65mm		
Dimension	Φ =60 mm, Thickness=26.85 mm		
Luminous Flux	456 lm	Measured @ 3.09 W	
Material	PC / UL94V2		

cd/klm

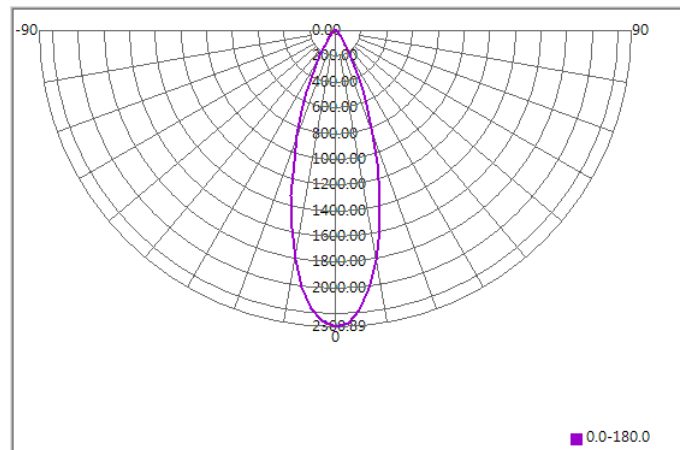

Illuminance At Distances

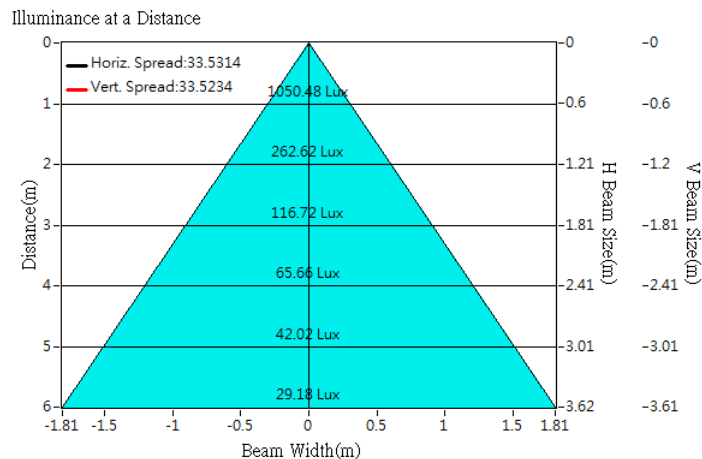



Optical Characteristics

Model Number	CKO-CH15-060027-4305		<p>"H" definition</p>
LED	Fortimo SLM 1202 L09 G7N		
LES / LED Size	Φ 9.8 mm		
FWHM (D50)	22°		
Field Angle (D10)	45°		
H (distance)	3.65mm		
Dimension	Φ =60 mm, Thickness=26.85 mm		
Luminous Flux	876 lm	Measured @ 6.1 W	
Material	PC / UL94V2		

cd/klm

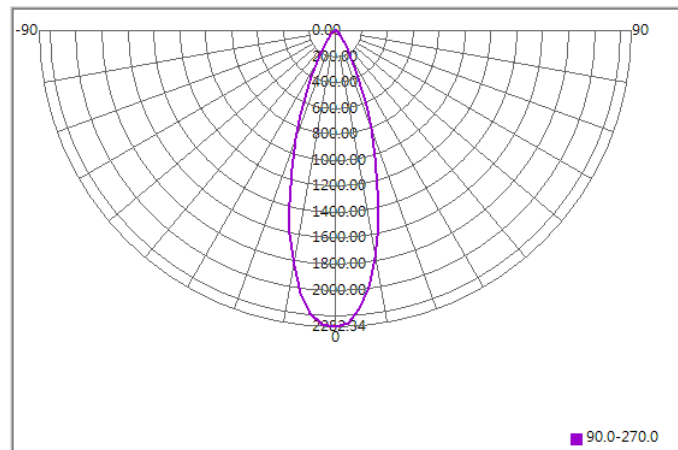

Illuminance At Distances

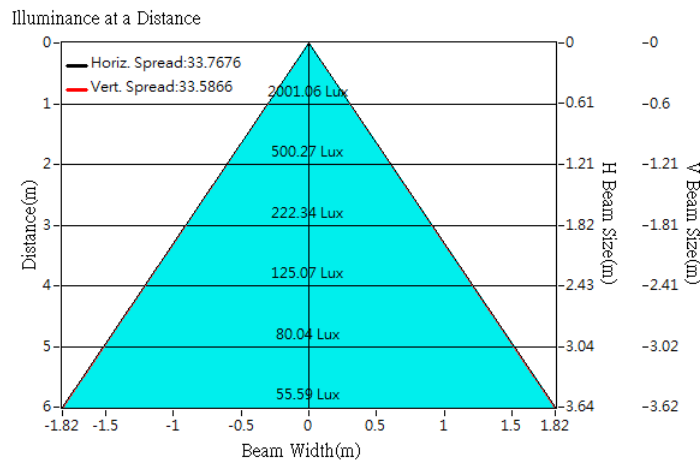



Optical Characteristics

Model Number	CKO-CH15-060027-4305		<p>"H" definition</p>
LED	Fortimo SLM 1203 L09 G7N		
LES / LED Size	Φ 9.8 mm		
FWHM (D50)	21°		
Field Angle (D10)	44°		
H (distance)	3.65mm		
Dimension	Φ =60 mm, Thickness=26.85 mm		
Luminous Flux	1323 lm	Measured @ 9.2 W	
Material	PC / UL94V2		

cd/klm

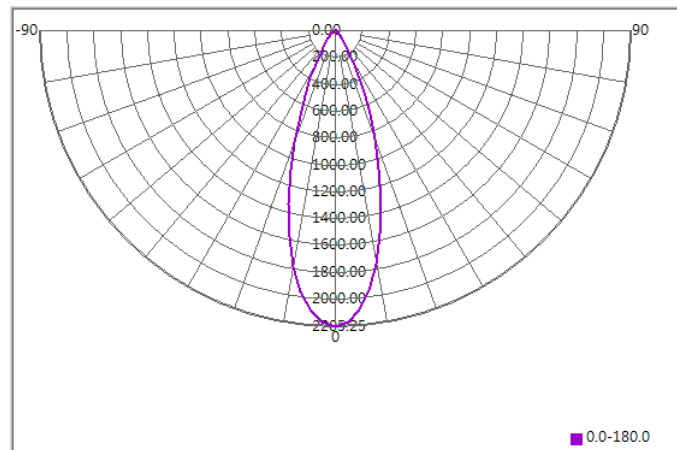

Illuminance At Distances

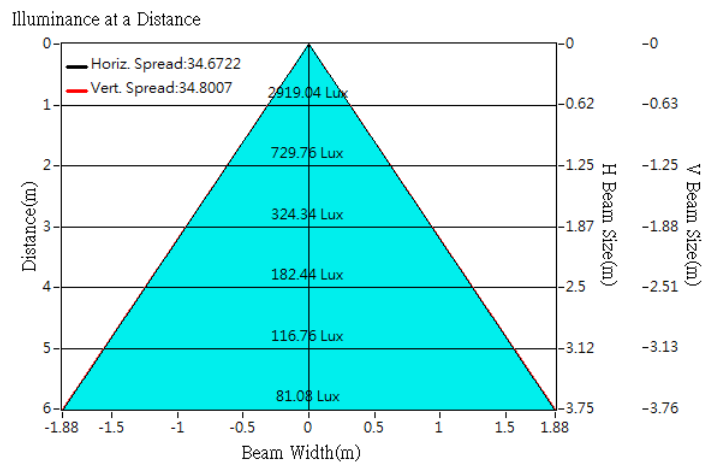



Optical Characteristics

Model Number	CKO-CH15-060027-4305		<p>"H" definition</p> <p>LES CoB</p>
LED	Fortimo SLM 1204 L09 G7N		
LES / LED Size	Φ 9.8 mm		
FWHM (D50)	21°		
Field Angle (D10)	43°		
H (distance)	3.65mm		
Dimension	Φ =60 mm, Thickness=26.85 mm		
Luminous Flux	1730 lm	Measured @ 12.3 W	
Material	PC / UL94V2		

cd/klm

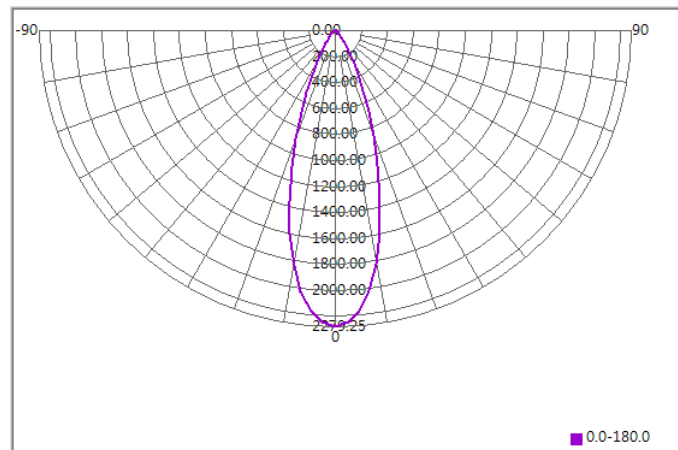

Illuminance At Distances

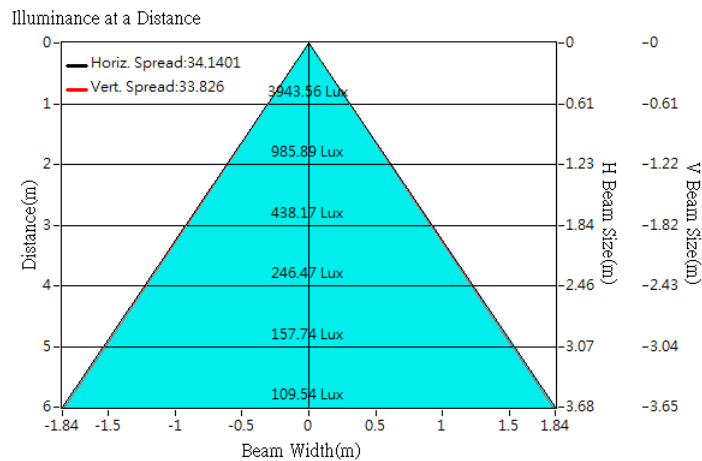



Optical Characteristics

Model Number	CKO-CH15-060027-4305		<p>"H" definition</p>
LED	Fortimo SLM 1205 L13 G7		
LES / LED Size	Φ 13 mm		
FWHM (D50)	39°		
Field Angle (D10)	71°		
H (distance)	3.65mm		
Dimension	Φ =60 mm, Thickness=26.85 mm		
Luminous Flux	2240 lm	Measured @ 17.6 W	
Material	PC / UL94V2		

cd/klm

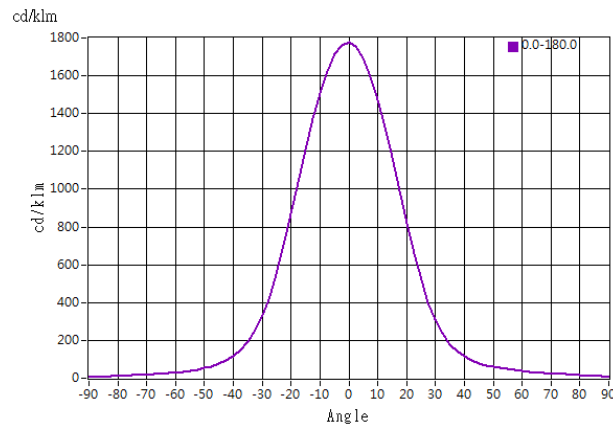

Illuminance At Distances

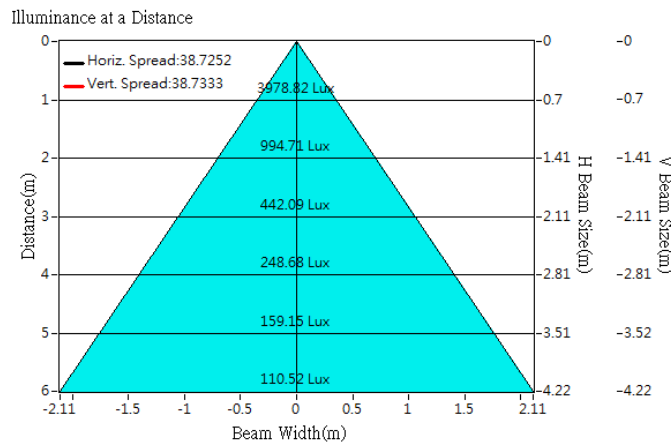



Optical Characteristics

Model Number	CKO-CH15-060027-4305		<p>"H" definition</p>
LED	Fortimo SLM 1205 L13 G6		
LES / LED Size	Φ 13 mm		
FWHM (D50)	38°		
Field Angle (D10)	69°		
H (distance)	3.65mm		
Dimension	Φ =60 mm, Thickness=26.85 mm		
Luminous Flux	1762 lm	Measured @ 13.5 W	
Material	PC / UL94V2		

cd/klm

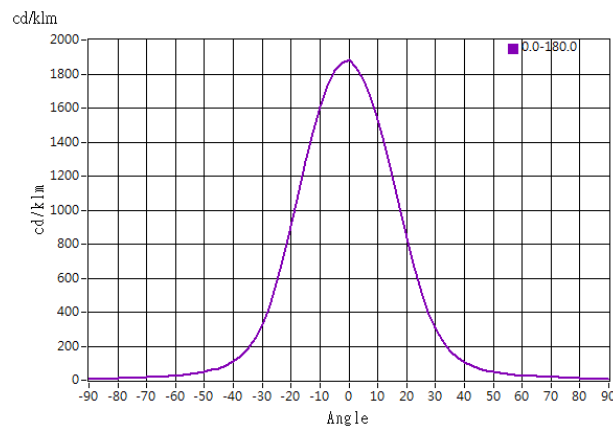

Illuminance At Distances

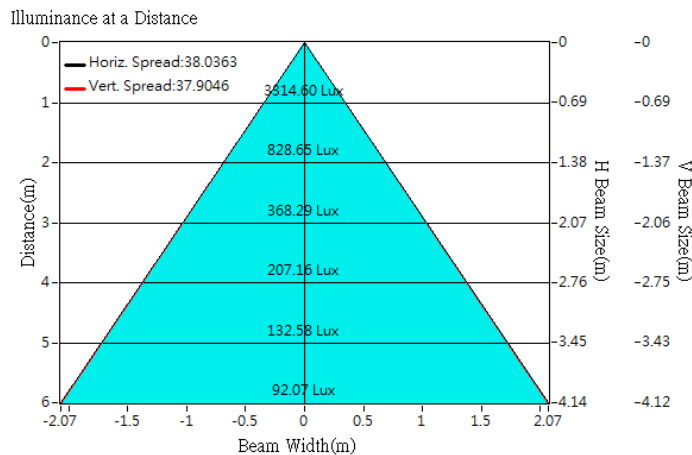



Optical Characteristics

Model Number	CKO-CH15-060027-4305		<p>"H" definition</p>
LED	Fortimo SLM PW 1205 L13 G6_DL		
LES / LED Size	Φ 13 mm		
FWHM (D50)	39°		
Field Angle (D10)	70°		
H (distance)	3.5mm		
Dimension	Φ =60 mm, Thickness=26.85 mm		
Luminous Flux	2230 lm	Measured @ 17.3 W	
Material	PC / UL94V2		

cd/klm

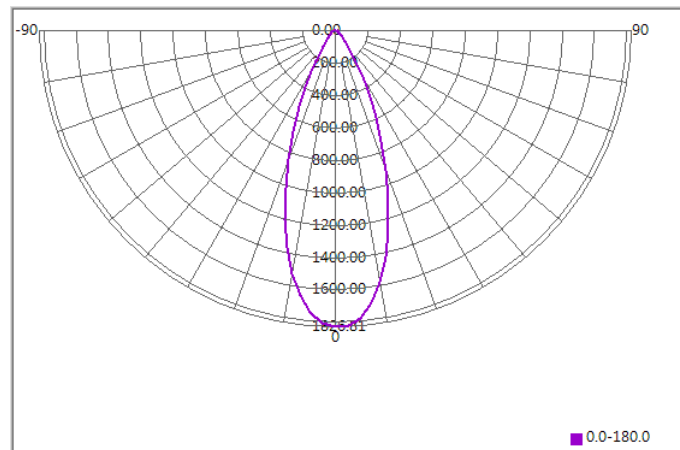

Illuminance At Distances

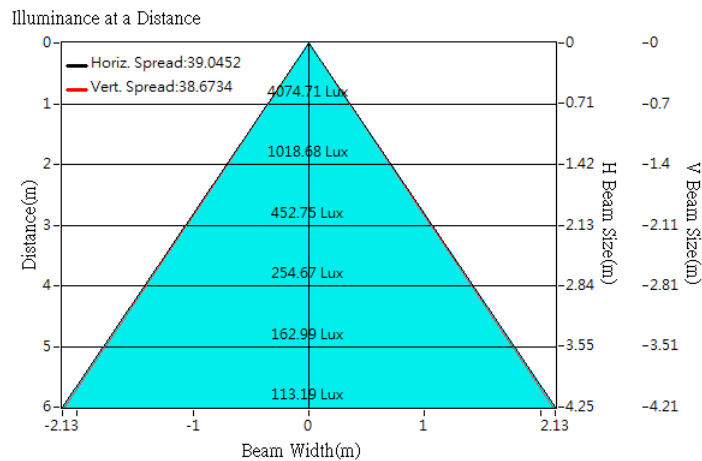



Optical Characteristics

Model Number	CKO-CH15-060027-4305		<p>"H" definition</p>
LED	Fortimo SLM PW 1205 L13 G6_PI		
LES / LED Size	Φ 13 mm		
FWHM (D50)	39°		
Field Angle (D10)	70°		
H (distance)	3.5mm		
Dimension	Φ =60 mm, Thickness=26.85 mm		
Luminous Flux	2230 lm	Measured @ 17.3 W	
Material	PC / UL94V2		

cd/klm

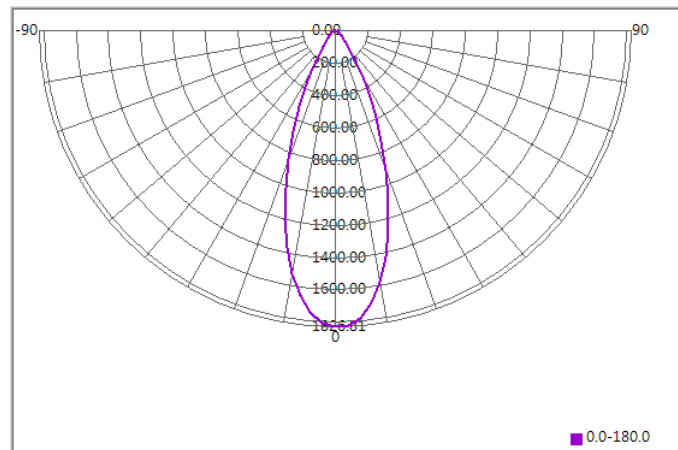

Illuminance At Distances

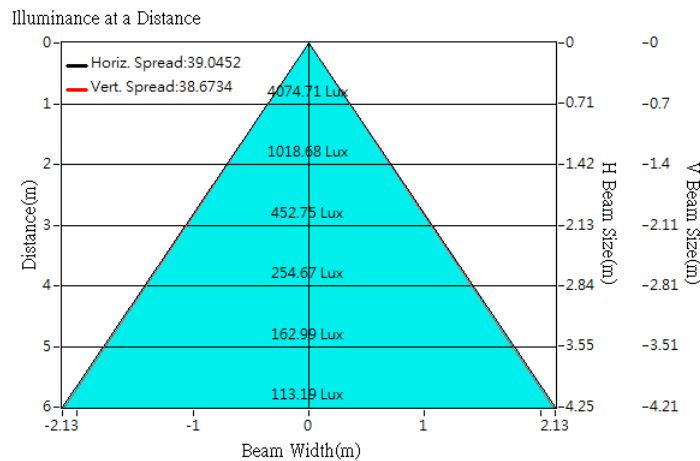



Optical Characteristics

Model Number	CKO-CH15-060027-4305		<p>"H" definition</p>
LED	Fortimo SLM 1205 L15 G7N		
LES / LED Size	Φ 14.5 mm		
FWHM (D50)	40°		
Field Angle (D10)	70°		
H (distance)	3.65mm		
Dimension	Φ =60 mm, Thickness=26.85 mm		
Luminous Flux	2174 lm	Measured @ 15.4 W	
Material	PC / UL94V2		

cd/klm

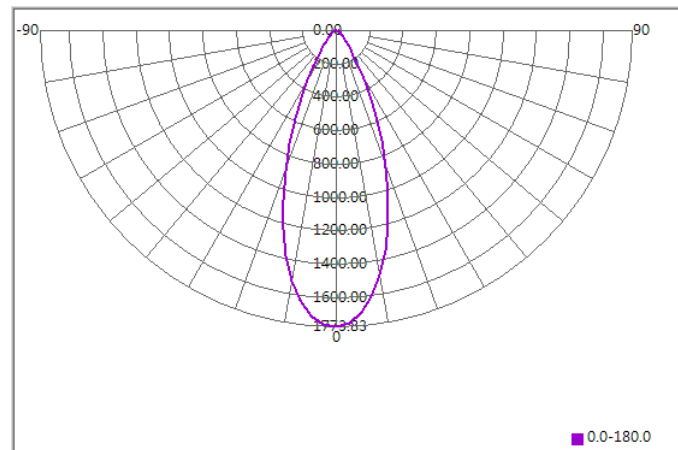

Illuminance At Distances

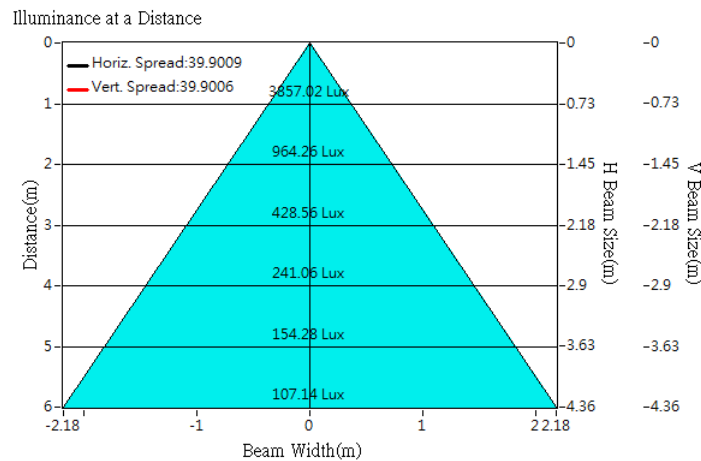



Optical Characteristics

Model Number	CKO-CH15-060027-4305		<p>"H" definition</p>
LED	Fortimo SLM 1206 L15 G7N		
LES / LED Size	Φ 14.5 mm		
FWHM (D50)	40°		
Field Angle (D10)	71°		
H (distance)	3.65mm		
Dimension	Φ =60 mm, Thickness=26.85 mm		
Luminous Flux	2597 lm	Measured @ 18.5 W	
Material	PC / UL94V2		

cd/klm

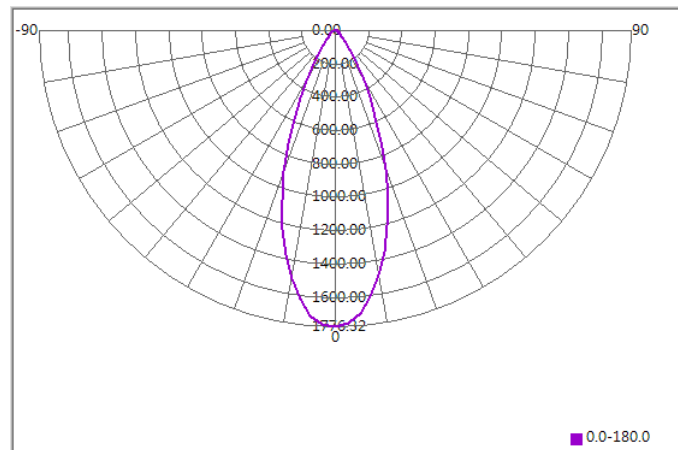

Illuminance At Distances

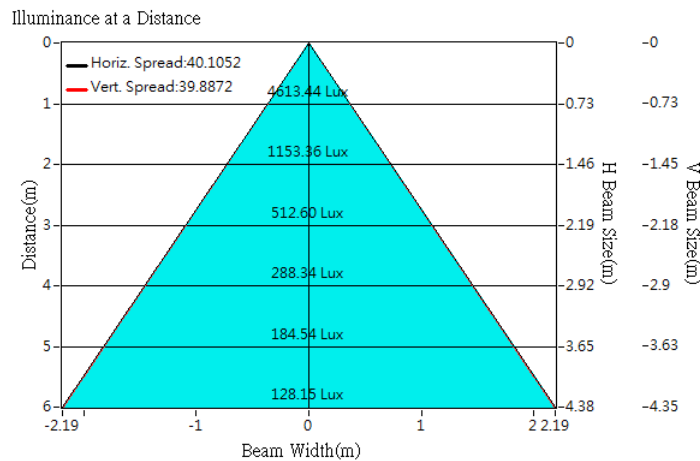

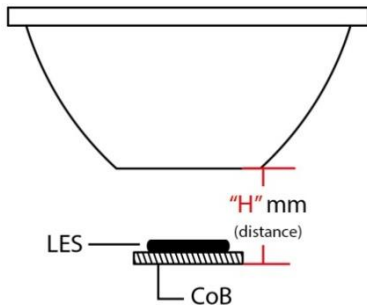

Optical Characteristics

Model Number	CKO-CH15-060027-4305		<p>"H" definition</p> 
LED	Fortimo SLM 1208 L15 G7N		
LES / LED Size	Φ 14.5 mm		
FWHM (D50)	40°		
Field Angle (D10)	71°		
H (distance)	3.65mm		
Dimension	Φ =60 mm, Thickness=26.85 mm		
Luminous Flux	3664 lm	Measured @ 24.7 W	
Material	PC / UL94V2		

cd/klm

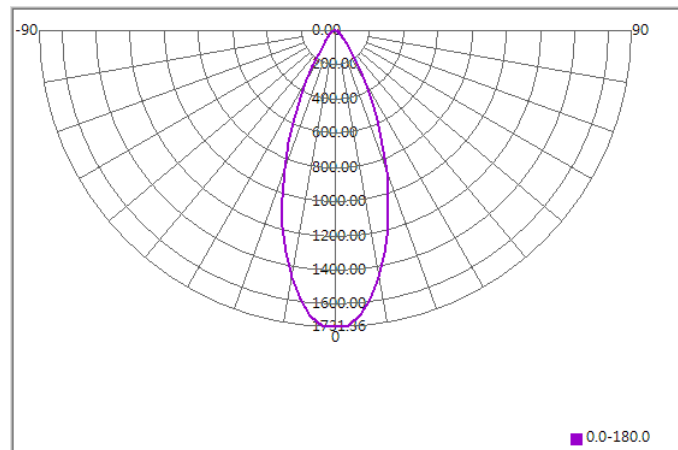

Illuminance At Distances

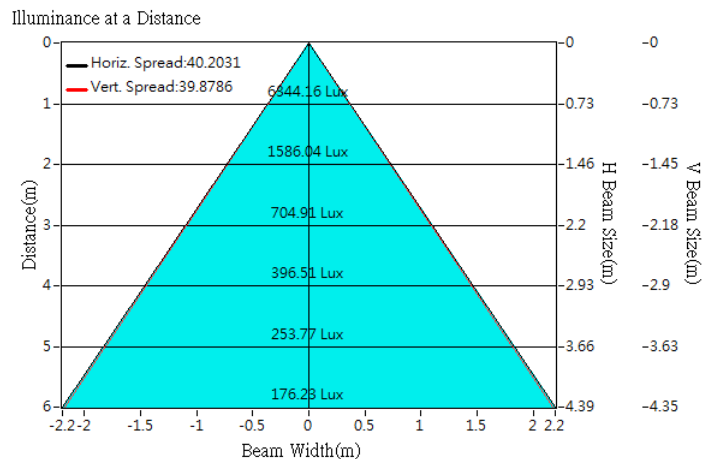

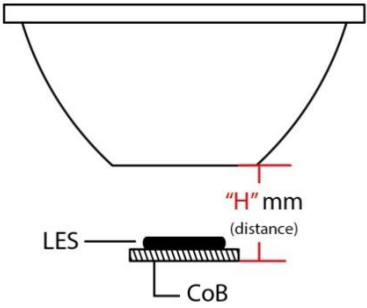

Optical Characteristics

Model Number	CKO-CH15-060027-4305		<p>"H" definition</p> 
LED	Fortimo SLM 1208 L15 G7		
LES / LED Size	Φ 15 mm		
FWHM (D50)	41°		
Field Angle (D10)	73°		
H (distance)	3.65mm		
Dimension	Φ =60 mm, Thickness=26.85 mm		
Luminous Flux	3045 lm	Measured @ 25.9 W	
Material	PC / UL94V2		

cd/klm

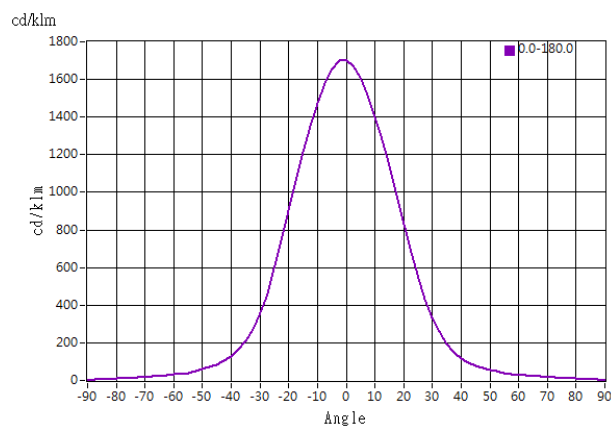

Illuminance At Distances

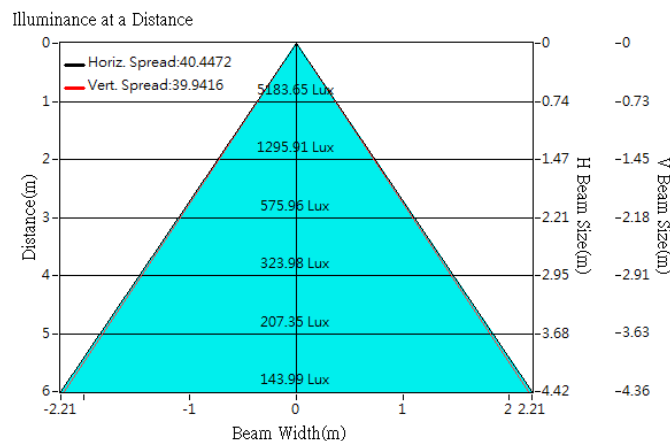



Optical Characteristics

Model Number	CKO-CH15-060027-4305		
LED	Fortimo SLM 1208 L15 G6		
LES / LED Size	Φ 15 mm		
FWHM (D50)	40°		
Field Angle (D10)	71°		
H (distance)	3.65mm		
Dimension	Φ =60 mm, Thickness=26.85 mm		
Luminous Flux	2525 lm	Measured @ 26.7 W	
Material	PC / UL94V2		

cd/klm

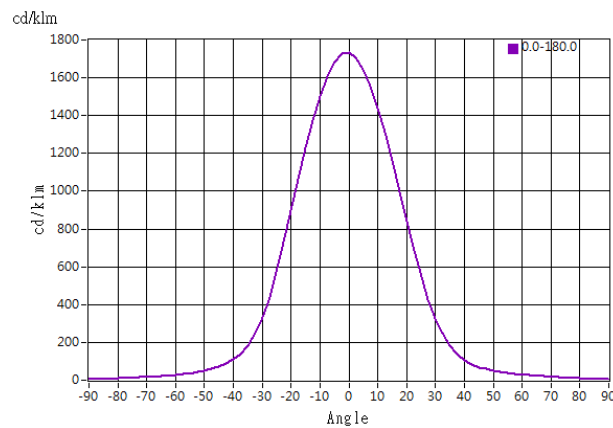

Illuminance At Distances

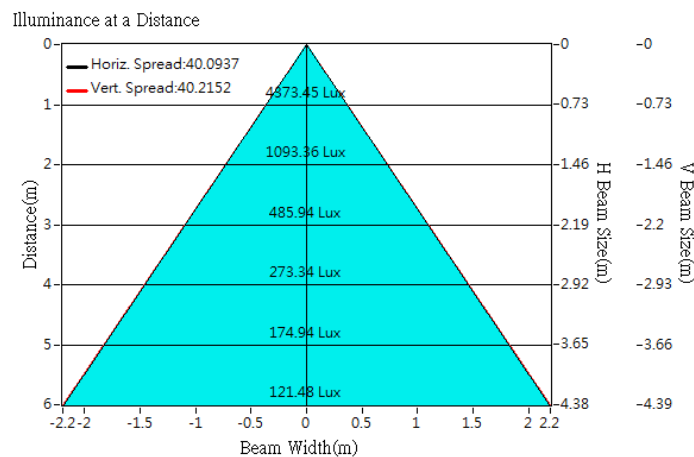



Optical Characteristics

Model Number	CKO-CH15-060027-4305		<p>"H" definition</p>
LED	Fortimo SLM 1208 L15 G6_DL		
LES / LED Size	Φ 15 mm		
FWHM (D50)	41°		
Field Angle (D10)	73°		
H (distance)	3.5mm		
Dimension	Φ =60 mm, Thickness=26.85 mm		
Luminous Flux	2607 lm	Measured @ 26.8 W	
Material	PC / UL94V2		

cd/klm

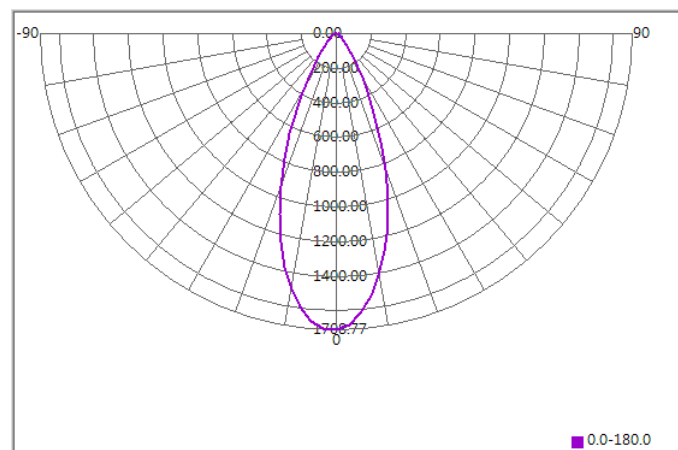

Illuminance At Distances

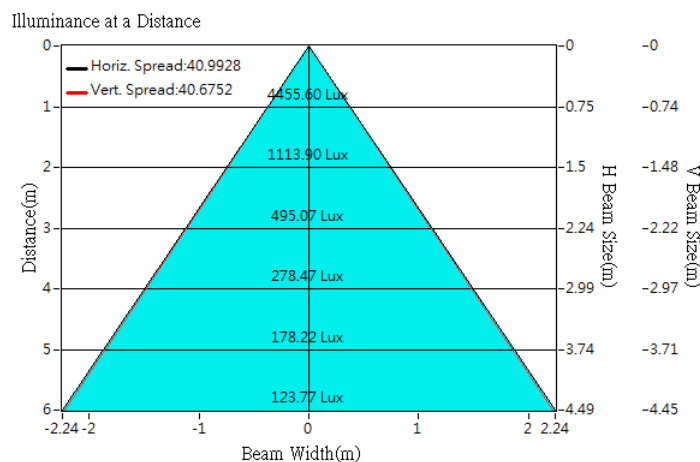



Optical Characteristics

Model Number	CKO-CH15-060027-4305		
LED	Fortimo SLM 1208 L15 G6_PI		
LES / LED Size	Φ 15 mm		
FWHM (D50)	41°		
Field Angle (D10)	73°		
H (distance)	3.5mm		
Dimension	Φ =60 mm, Thickness=26.85 mm		
Luminous Flux	2607 lm	Measured @ 26.8 W	
Material	PC / UL94V2		

cd/klm

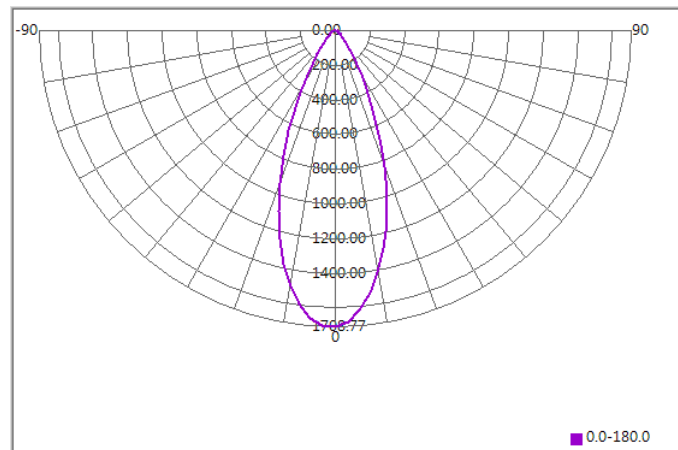

Illuminance At Distances

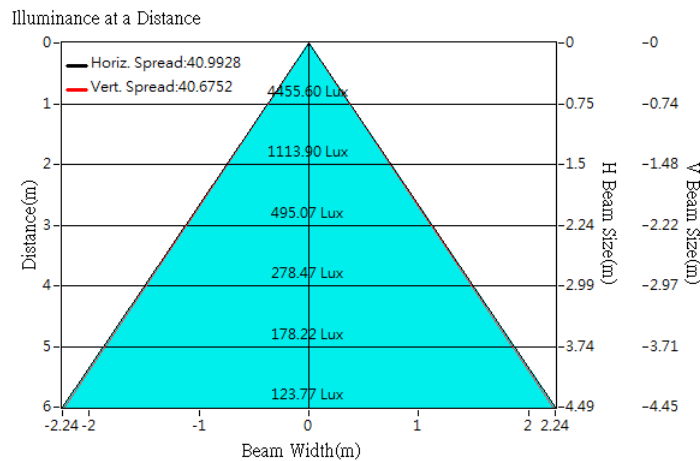



Lens Accessories - CoB Holder

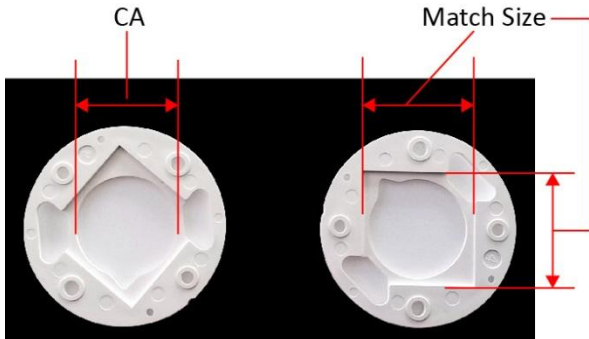

Example of LES Area & LED Size Dimension Locations

Product Model	Match Size (mm)	CA (mm)	Material	Applicability
CKO-HC14-161911-0501	16.3 x 19.3	Φ 11.9	PBT	Philips 1202
CKO-HC14-161911-0501	16.3 x 19.3	Φ 11.9	PBT	Philips 1203
CKO-HC14-202419-0502	20.3 x 24.3	Φ 19.2	PBT	Philips 1204
CKO-HC14-202419-0502	20.3 x 24.3	Φ 19.2	PBT	Philips 1205