



## Product Model Number

CKO-CH15-060027-4307

### ✓ Model Number Definitions

**CKO-XXXX-XXXXXX-XXXX**

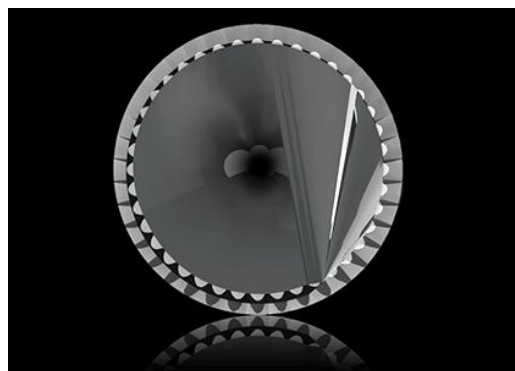

- A. Chun Kuang Optics Corp. Product
- B. Product Type: product abbreviation  
Ex:  
CH→CoB High Intensity  
CC→CoB Compact  
CS→Soft Shading for CoB LED  
HC→Holder for CoB LED

- C. Identity Code
- D. Lens / Fixture Size  
Ex: 075026=Φ75mm / Thickness=26mm (round up)
- C. Serial Numbers

The lens datasheet is applicable for **CREE LED**, that manufactured by Chun Kuang Optics Corp.

### ✓ Dimensions (mm) : Φ60 x 26.85

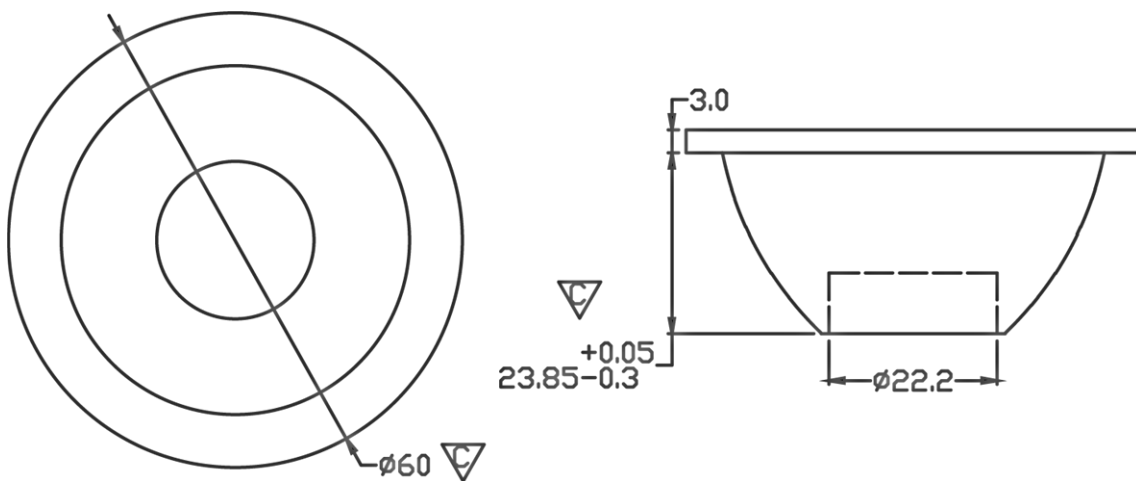

▽:Critical Dimension



✓ Optical Characteristics – Angle Performances

| CREE    | LED LES (mm) | FWHM (degrees) | Field Angle (degrees) |
|---------|--------------|----------------|-----------------------|
| XHP50   | 5.0 x 5.0    | 42°            | 75°                   |
| CXA1304 | Φ6           | 37°            | 64°                   |
| CXB1304 | Φ6           | 36°            | 69°                   |
| CXA1310 | Φ6           | 37°            | 69°                   |
| CXB1310 | Φ6           | 36°            | 68°                   |
| CXA1507 | Φ9           | 37°            | 64°                   |
| CXB1507 | Φ9           | 39°            | 71°                   |
| CXA1510 | Φ9           | 39°            | 66°                   |
| CXA1512 | Φ9           | 39°            | 65°                   |
| CXB1512 | Φ9           | 38°            | 65°                   |
| CMA1516 | Φ9           | 39°            | 71°                   |
| CXA1520 | Φ9           | 38°            | 64°                   |
| CXB1520 | Φ9           | 38°            | 70°                   |
| CMT1407 | Φ9.8         | 38°            | 69°                   |
| CMT1420 | Φ9.8         | 38°            | 69°                   |
| CXA1816 | Φ12          | 40°            | 68°                   |
| CXB1816 | Φ12          | 41°            | 68°                   |
| CXA1820 | Φ12          | 42°            | 69°                   |
| CXB1820 | Φ12          | 42°            | 70°                   |
| CMA1825 | Φ12          | 42°            | 74°                   |
| CXA1850 | Φ12          | 41°            | 69°                   |
| CXA1830 | Φ14          | 42°            | 71°                   |
| CXB1830 | Φ14          | 42°            | 71°                   |
| CMA1840 | Φ14          | 43°            | 76°                   |
| CMT1922 | Φ14.5        | 43°            | 76°                   |
| CMT1925 | Φ14.5        | 44°            | 79°                   |
| CMT1930 | Φ14.5        | 43°            | 77°                   |
| CMT1945 | Φ14.5        | 43°            | 77°                   |
| CXA2520 | Φ19          | 46°            | 83°                   |
| CXA2530 | Φ19          | 45°            | 78°                   |
| CXB2530 | Φ19          | 48°            | 86°                   |





## Optical Characteristics

|                   |                              |                  |                       |
|-------------------|------------------------------|------------------|-----------------------|
| Model Number      | CKO-CH15-060027-4307         |                  | <p>"H" definition</p> |
| LED               | <b>CREE XHP50</b>            |                  |                       |
| LES / LED Size    | Φ 5.0X5.0 mm                 |                  |                       |
| FWHM (D50)        | 42°                          |                  |                       |
| Field Angle (D10) | 75°                          |                  |                       |
| H (distance)      | 3.65mm                       |                  |                       |
| Dimension         | Φ =60 mm, Thickness=26.85 mm |                  |                       |
| Luminous Flux     | 770 lm                       | Measured @ 8.4 W |                       |
| Material          | PC / UL94V2                  |                  |                       |

## cd/klm

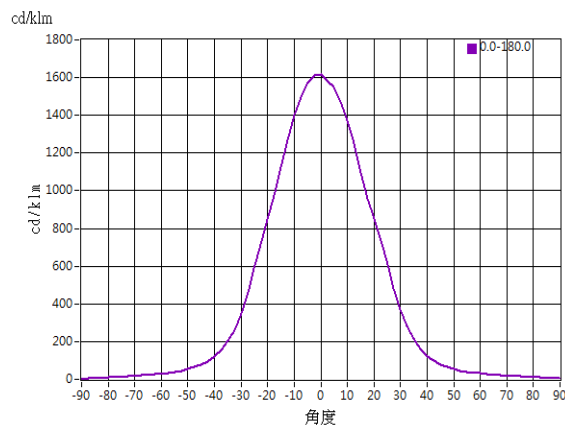

## Illuminance At Distances

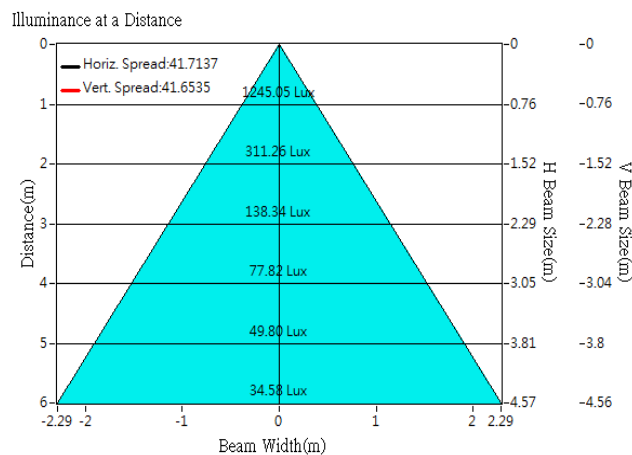



## Optical Characteristics

|                   |                              |                  |                       |
|-------------------|------------------------------|------------------|-----------------------|
| Model Number      | CKO-CH15-060027-4307         |                  | <p>"H" definition</p> |
| LED               | <b>CREE CXA1304</b>          |                  |                       |
| LES / LED Size    | Φ 6 mm                       |                  |                       |
| FWHM (D50)        | 37°                          |                  |                       |
| Field Angle (D10) | 64°                          |                  |                       |
| H (distance)      | 3.65mm                       |                  |                       |
| Dimension         | Φ =60 mm, Thickness=26.85 mm |                  |                       |
| Luminous Flux     | 310 lm                       | Measured @ 3.1 W |                       |
| Material          | PC / UL94V2                  |                  |                       |

## cd/klm

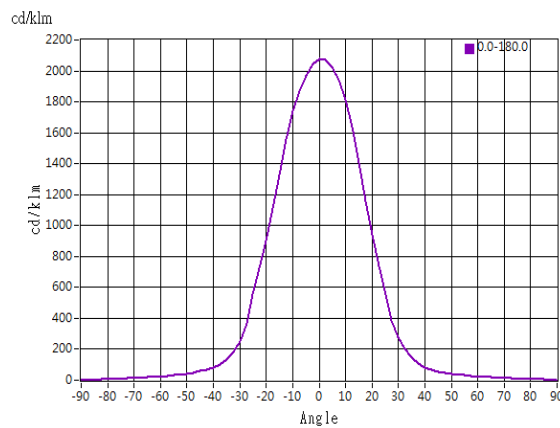

## Illuminance At Distances

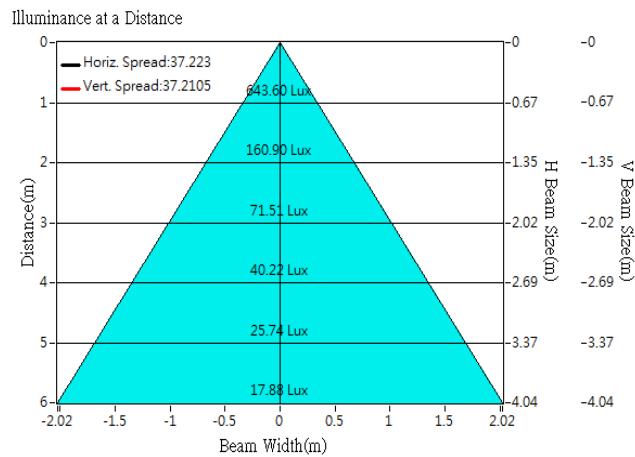



## Optical Characteristics

|                   |                              |                  |                       |
|-------------------|------------------------------|------------------|-----------------------|
| Model Number      | CKO-CH15-060027-4307         |                  | <p>"H" definition</p> |
| LED               | CREE CXB1304                 |                  |                       |
| LES / LED Size    | Φ 6 mm                       |                  |                       |
| FWHM (D50)        | 36°                          |                  |                       |
| Field Angle (D10) | 69°                          |                  |                       |
| H (distance)      | 3.65mm                       |                  |                       |
| Dimension         | Φ =60 mm, Thickness=26.85 mm |                  |                       |
| Luminous Flux     | 421 lm                       | Measured @ 3.5 W |                       |
| Material          | PC / UL94V2                  |                  |                       |

## cd/klm

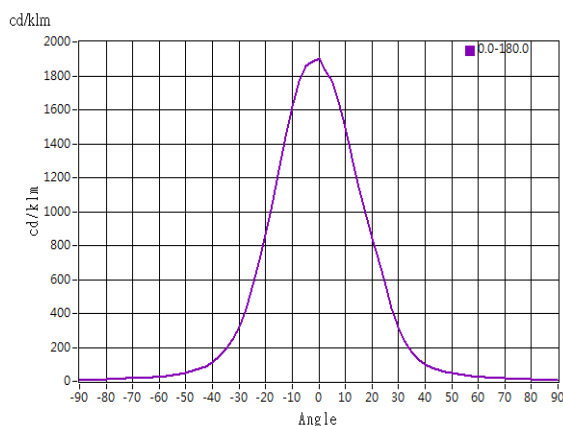

## Illuminance At Distances

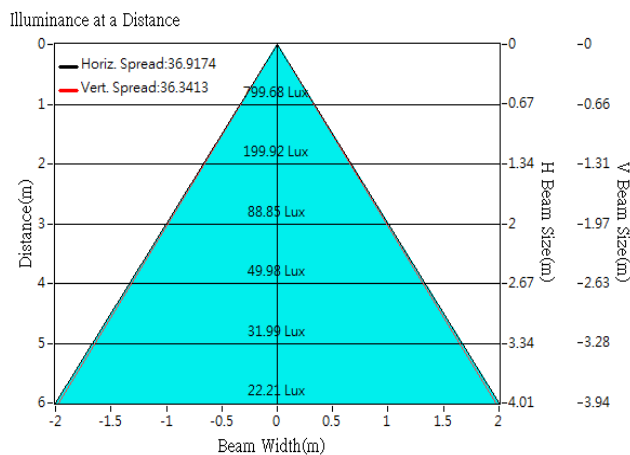



## Optical Characteristics

|                   |                              |                   |                       |
|-------------------|------------------------------|-------------------|-----------------------|
| Model Number      | CKO-CH15-060027-4307         |                   | <p>"H" definition</p> |
| LED               | <b>CREE CXA1310</b>          |                   |                       |
| LES / LED Size    | Φ 6 mm                       |                   |                       |
| FWHM (D50)        | 37°                          |                   |                       |
| Field Angle (D10) | 69°                          |                   |                       |
| H (distance)      | 3.65mm                       |                   |                       |
| Dimension         | Φ =60 mm, Thickness=26.85 mm |                   |                       |
| Luminous Flux     | 1030 lm                      | Measured @ 12.8 W |                       |
| Material          | PC / UL94V2                  |                   |                       |

## cd/klm

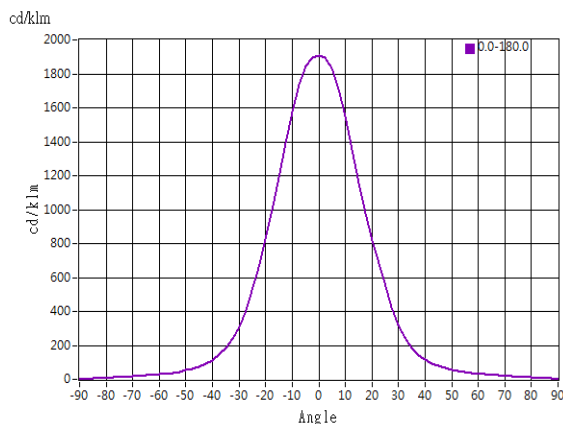

## Illuminance At Distances

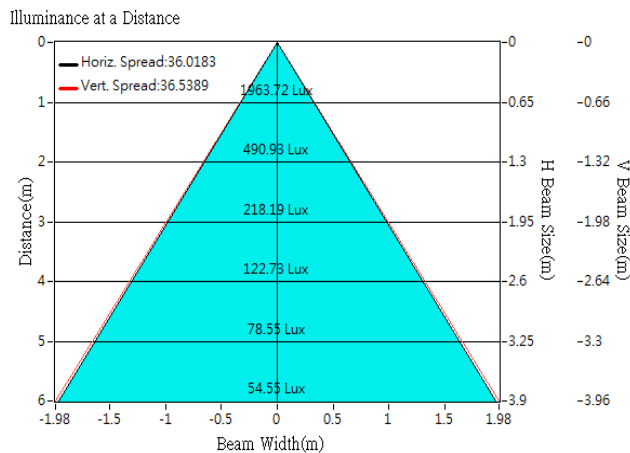



## Optical Characteristics

|                   |                              |                   |                       |
|-------------------|------------------------------|-------------------|-----------------------|
| Model Number      | CKO-CH15-060027-4307         |                   | <p>"H" definition</p> |
| LED               | <b>CREE CXB1310</b>          |                   |                       |
| LES / LED Size    | Φ 6 mm                       |                   |                       |
| FWHM (D50)        | 36°                          |                   |                       |
| Field Angle (D10) | 68°                          |                   |                       |
| H (distance)      | 3.65mm                       |                   |                       |
| Dimension         | Φ =60 mm, Thickness=26.85 mm |                   |                       |
| Luminous Flux     | 1406 lm                      | Measured @ 11.9 W |                       |
| Material          | PC / UL94V2                  |                   |                       |

## cd/klm

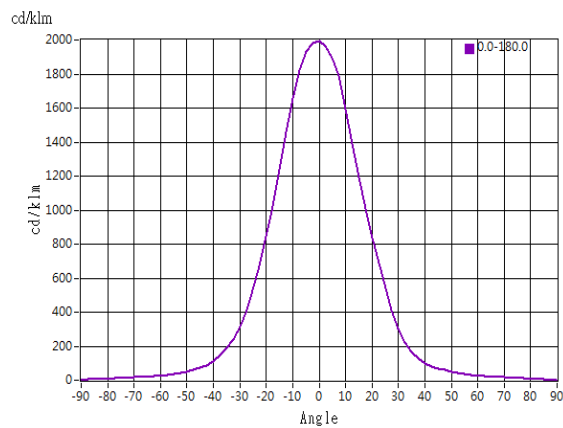

## Illuminance At Distances

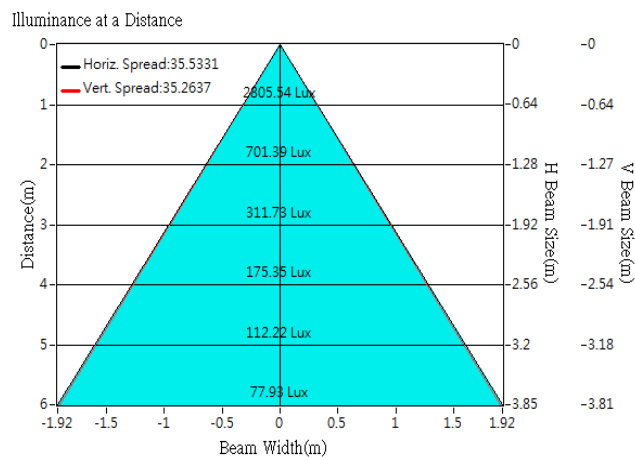



## Optical Characteristics

|                   |                              |                  |                       |
|-------------------|------------------------------|------------------|-----------------------|
| Model Number      | CKO-CH15-060027-4307         |                  | <p>"H" definition</p> |
| LED               | <b>CREE CXA1507</b>          |                  |                       |
| LES / LED Size    | Φ 9 mm                       |                  |                       |
| FWHM (D50)        | 37°                          |                  |                       |
| Field Angle (D10) | 64°                          |                  |                       |
| H (distance)      | 3.65mm                       |                  |                       |
| Dimension         | Φ =60 mm, Thickness=26.85 mm |                  |                       |
| Luminous Flux     | 685 lm                       | Measured @ 7.3 W |                       |
| Material          | PC / UL94V2                  |                  |                       |

## cd/klm

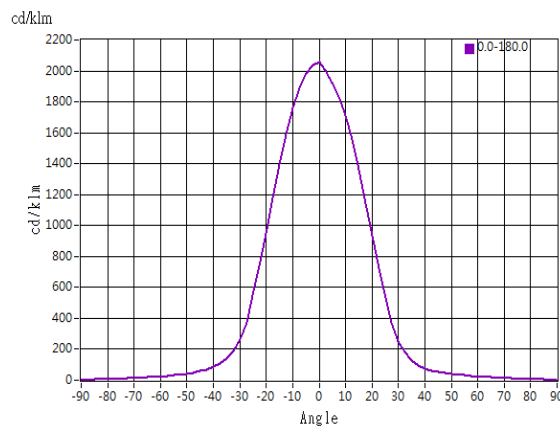

## Illuminance At Distances

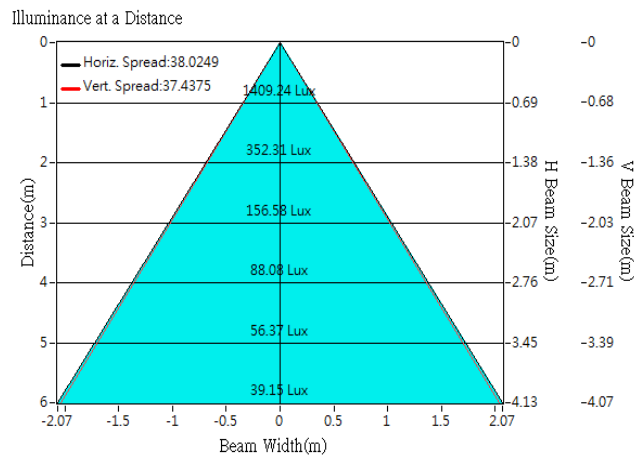



## Optical Characteristics

|                   |                              |                  |                       |
|-------------------|------------------------------|------------------|-----------------------|
| Model Number      | CKO-CH15-060027-4307         |                  | <p>"H" definition</p> |
| LED               | <b>CREE CXB1507</b>          |                  |                       |
| LES / LED Size    | Φ 9 mm                       |                  |                       |
| FWHM (D50)        | 39°                          |                  |                       |
| Field Angle (D10) | 71°                          |                  |                       |
| H (distance)      | 3.65mm                       |                  |                       |
| Dimension         | Φ =60 mm, Thickness=26.85 mm |                  |                       |
| Luminous Flux     | 817 lm                       | Measured @ 7.1 W |                       |
| Material          | PC / UL94V2                  |                  |                       |

## cd/klm

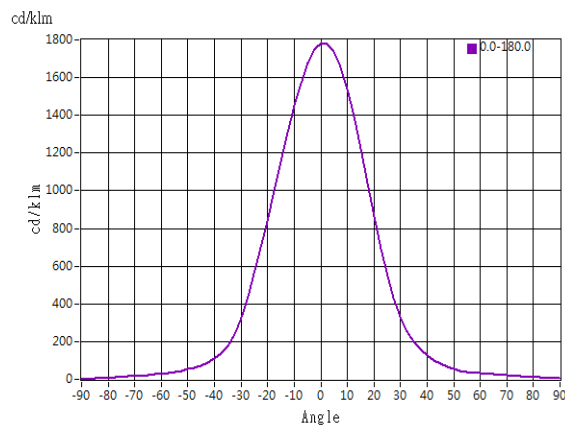

## Illuminance At Distances

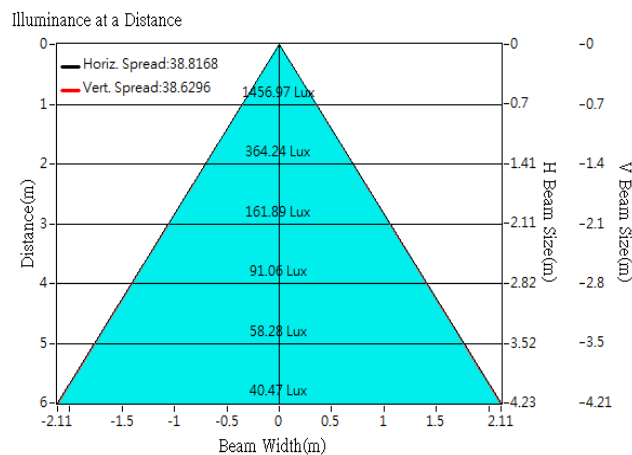



## Optical Characteristics

|                   |                              |                       |
|-------------------|------------------------------|-----------------------|
| Model Number      | CKO-CH15-060027-4307         | <p>"H" definition</p> |
| LED               | <b>CREE CXA1510</b>          |                       |
| LES / LED Size    | Φ 9 mm                       |                       |
| FWHM (D50)        | 39°                          |                       |
| Field Angle (D10) | 66°                          |                       |
| H (distance)      | 3.65mm                       |                       |
| Dimension         | Φ =60 mm, Thickness=26.85 mm |                       |
| Luminous Flux     | 974 lm                       |                       |
| Material          | PC / UL94V2                  |                       |

## cd/klm

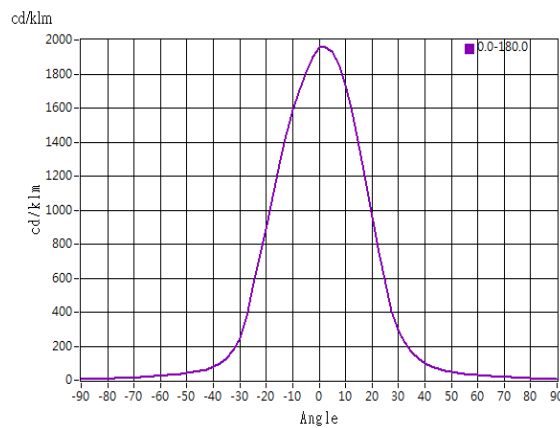

## Illuminance At Distances

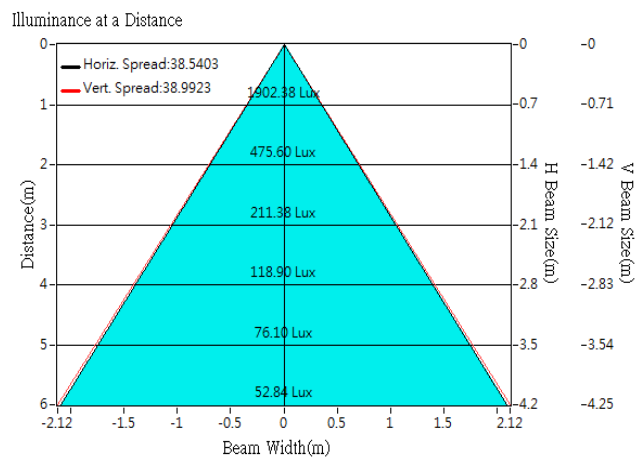



## Optical Characteristics

|                   |                              |  |
|-------------------|------------------------------|--|
| Model Number      | CKO-CH15-060027-4307         | <p>"H" definition</p> <p>LES<br/>CoB</p> |
| LED               | <b>CREE CXA1512</b>          |  |
| LES / LED Size    | Φ 9 mm                       |  |
| FWHM (D50)        | 39°                          |  |
| Field Angle (D10) | 65°                          |  |
| H (distance)      | 3.65mm                       |  |
| Dimension         | Φ =60 mm, Thickness=26.85 mm |  |
| Luminous Flux     | 1177lm                       |  |
| Material          | PC / UL94V2                  |  |

## cd/klm

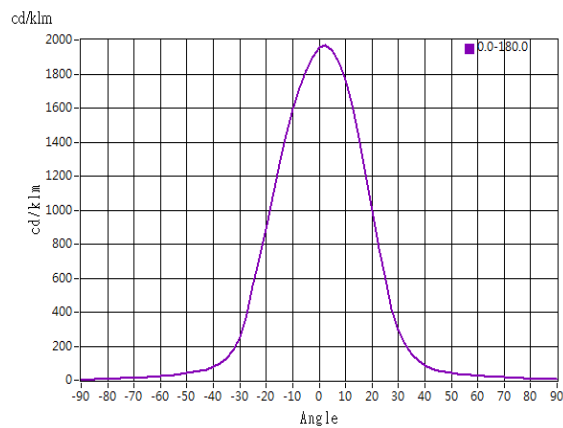

## Illuminance At Distances

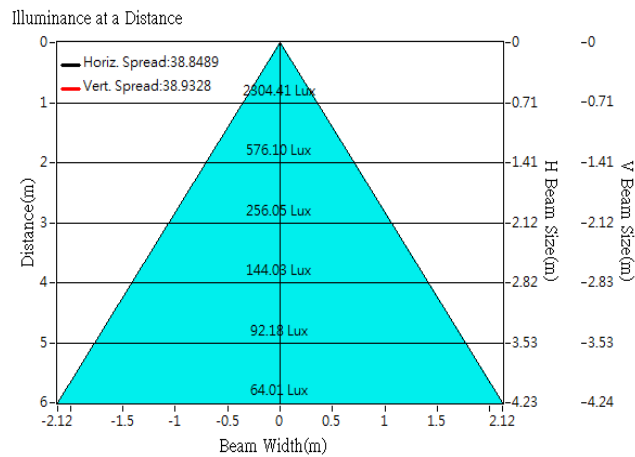



## Optical Characteristics

|                   |                              |                       |                   |
|-------------------|------------------------------|-----------------------|-------------------|
| Model Number      | CKO-CH15-060027-4307         | <p>"H" definition</p> |                   |
| LED               | <b>CREE CXB1512</b>          |                       |                   |
| LES / LED Size    | Φ 9 mm                       |                       |                   |
| FWHM (D50)        | 38°                          |                       |                   |
| Field Angle (D10) | 65°                          |                       |                   |
| H (distance)      | 3.65mm                       |                       |                   |
| Dimension         | Φ =60 mm, Thickness=26.85 mm |                       |                   |
| Luminous Flux     | 2064lm                       |                       | Measured @ 21.6 W |
| Material          | PC / UL94V2                  |                       |                   |

## cd/klm

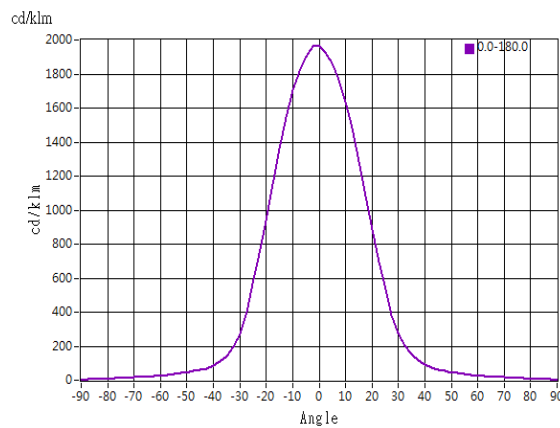

## Illuminance At Distances

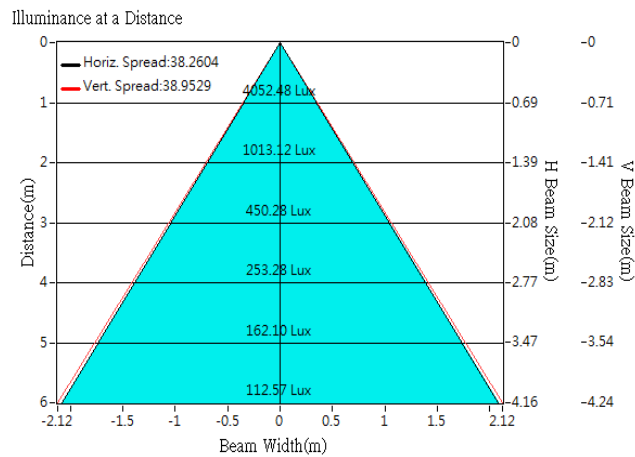



## Optical Characteristics

|                   |                                |  |
|-------------------|--------------------------------|--|
| Model Number      | CKO-CH15-060027-4307           | <p>"H" definition</p> <p>LES<br/>CoB</p> |
| LED               | <b>CREE CMA1516</b>            |  |
| LES / LED Size    | Φ 9 mm                         |  |
| FWHM (D50)        | 39°                            |  |
| Field Angle (D10) | 71°                            |  |
| H (distance)      | 3.65mm                         |  |
| Dimension         | Φ =60 mm, Thickness=26.85 mm   |  |
| Luminous Flux     | 1851 lm      Measured @ 15.8 W |  |
| Material          | PC / UL94V2                    |  |

## cd/klm

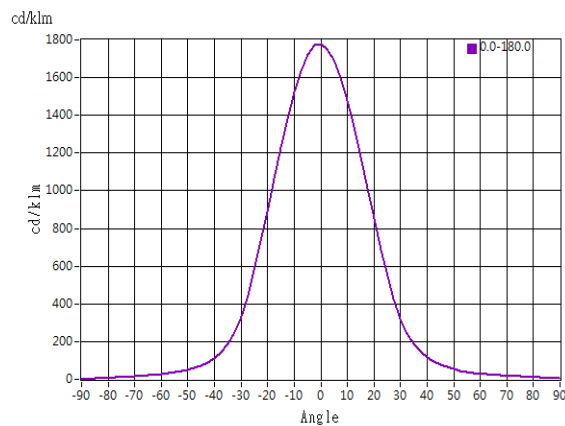

## Illuminance At Distances

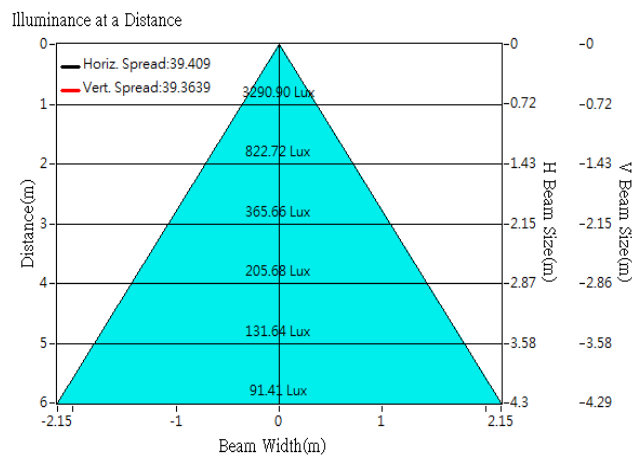



## Optical Characteristics

|                   |                                |                       |
|-------------------|--------------------------------|-----------------------|
| Model Number      | CKO-CH15-060027-4307           | <p>"H" definition</p> |
| LED               | <b>CREE CXA1520</b>            |                       |
| LES / LED Size    | Φ 9 mm                         |                       |
| FWHM (D50)        | 38°                            |                       |
| Field Angle (D10) | 64°                            |                       |
| H (distance)      | 3.65mm                         |                       |
| Dimension         | Φ =60 mm, Thickness=26.85 mm   |                       |
| Luminous Flux     | 1659 lm      Measured @ 18.1 W |                       |
| Material          | PC / UL94V2                    |                       |

## cd/klm

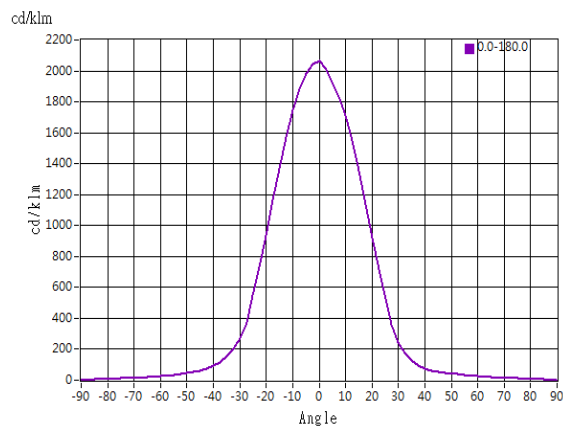

## Illuminance At Distances

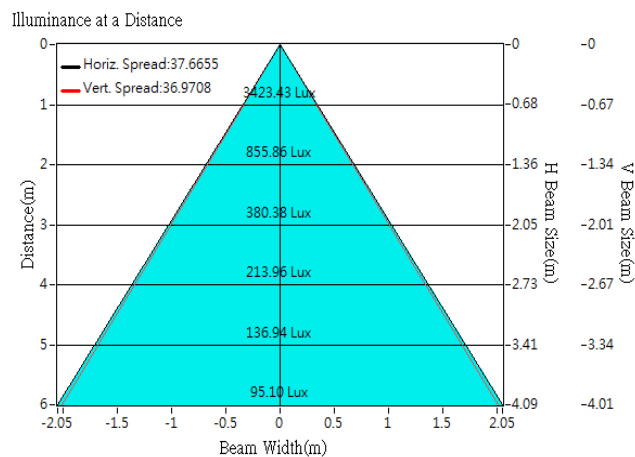

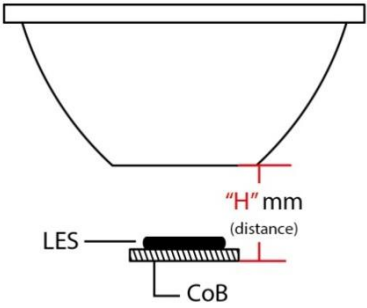

## Optical Characteristics

|                   |                                |  |
|-------------------|--------------------------------|--|
| Model Number      | CKO-CH15-060027-4307           | <p>"H" definition</p>  |
| LED               | <b>CREE CXB1520</b>            |  |
| LES / LED Size    | Φ 9 mm                         |  |
| FWHM (D50)        | 38°                            |  |
| Field Angle (D10) | 70°                            |  |
| H (distance)      | 3.65mm                         |  |
| Dimension         | Φ =60 mm, Thickness=26.85 mm   |  |
| Luminous Flux     | 1989 lm      Measured @ 16.5 W |  |
| Material          | PC / UL94V2                    |  |

## cd/klm

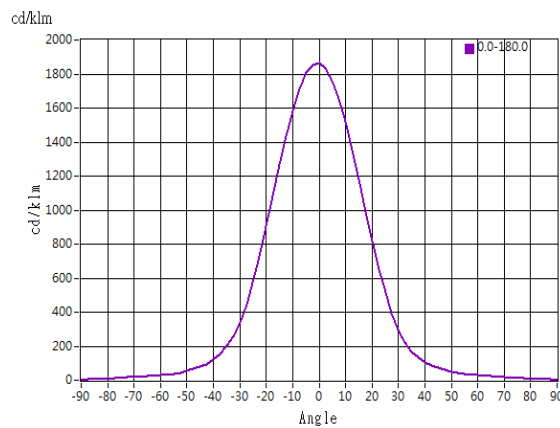

## Illuminance At Distances

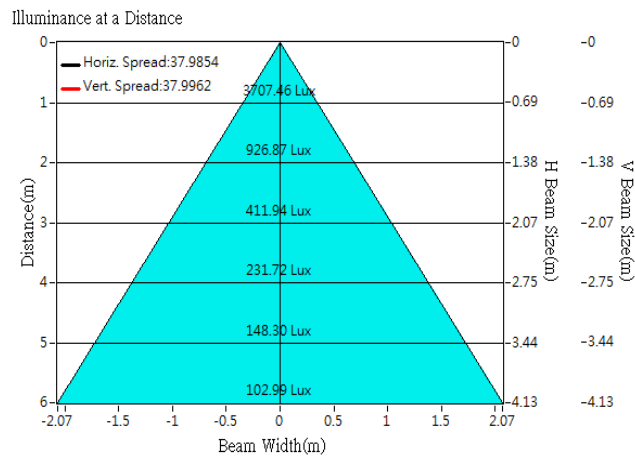



## Optical Characteristics

|                   |                              |  |
|-------------------|------------------------------|--|
| Model Number      | CKO-CH15-060027-4307         | <p>"H" definition</p> <p>LES<br/>CoB</p> |
| LED               | <b>CREE CMT1407</b>          |  |
| LES / LED Size    | Φ 9.8 mm                     |  |
| FWHM (D50)        | 38°                          |  |
| Field Angle (D10) | 69°                          |  |
| H (distance)      | 3.65mm                       |  |
| Dimension         | Φ =60 mm, Thickness=26.85 mm |  |
| Luminous Flux     | 866 lm      Measured @ 7 W   |  |
| Material          | PC / UL94V2                  |  |

## cd/klm

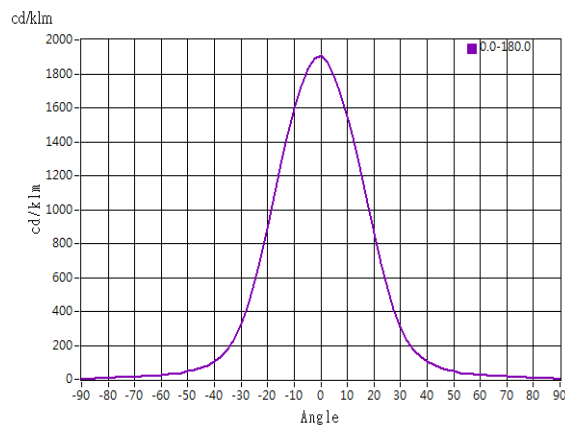

## Illuminance At Distances

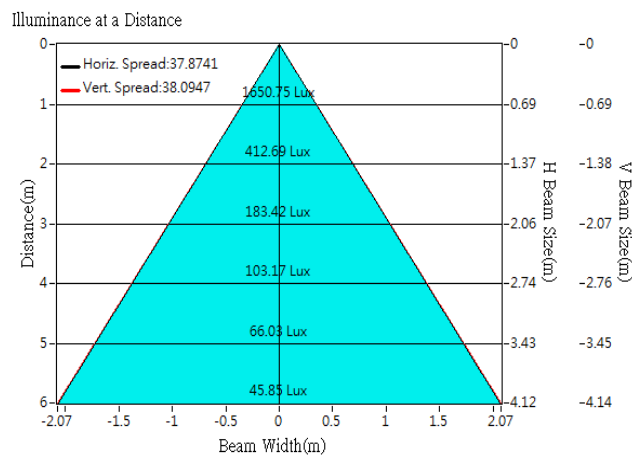



## Optical Characteristics

|                   |                              |                 |                       |
|-------------------|------------------------------|-----------------|-----------------------|
| Model Number      | CKO-CH15-060027-4307         |                 | <p>"H" definition</p> |
| LED               | <b>CREE CMT1420</b>          |                 |                       |
| LES / LED Size    | Φ 9.8 mm                     |                 |                       |
| FWHM (D50)        | 38°                          |                 |                       |
| Field Angle (D10) | 69°                          |                 |                       |
| H (distance)      | 3.65mm                       |                 |                       |
| Dimension         | Φ =60 mm, Thickness=26.85 mm |                 |                       |
| Luminous Flux     | 2251 lm                      | Measured @ 19 W |                       |
| Material          | PC / UL94V2                  |                 |                       |

## cd/klm

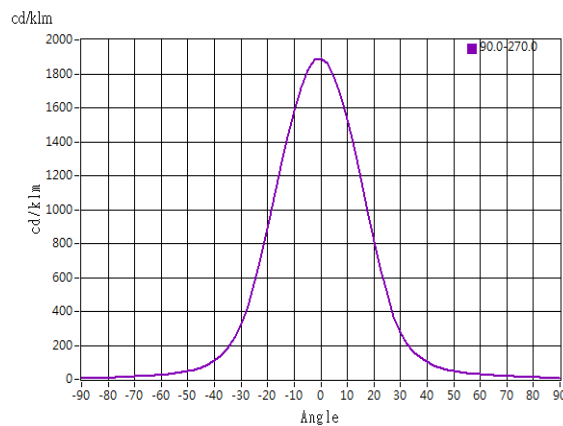

## Illuminance At Distances

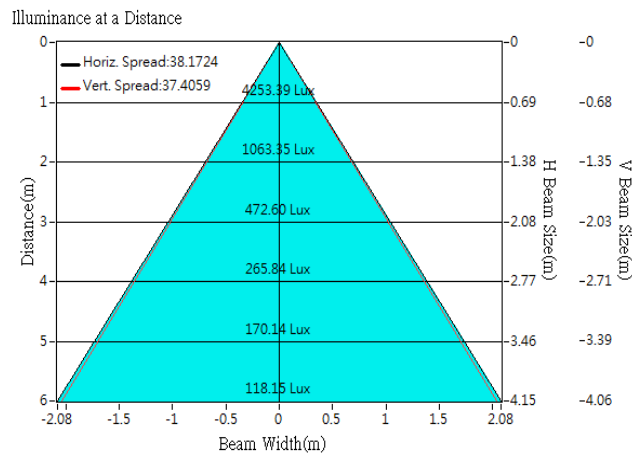



## Optical Characteristics

|                   |                              |                       |
|-------------------|------------------------------|-----------------------|
| Model Number      | CKO-CH15-060027-4307         | <p>"H" definition</p> |
| LED               | <b>CREE CXA1816</b>          |                       |
| LES / LED Size    | Φ 12 mm                      |                       |
| FWHM (D50)        | 40°                          |                       |
| Field Angle (D10) | 68°                          |                       |
| H (distance)      | 3.65mm                       |                       |
| Dimension         | Φ =60 mm, Thickness=26.85 mm |                       |
| Luminous Flux     | 1681 lm                      |                       |
| Material          | PC / UL94V2                  |                       |

## cd/klm

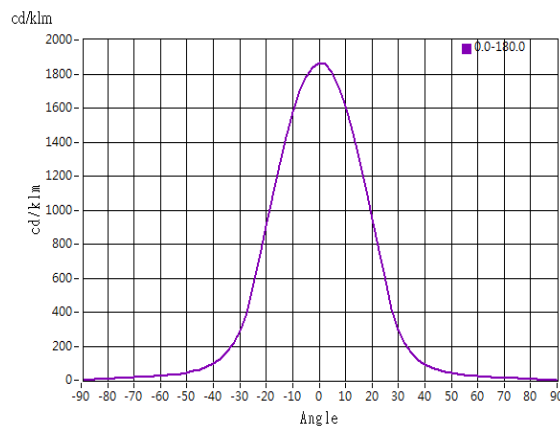

## Illuminance At Distances

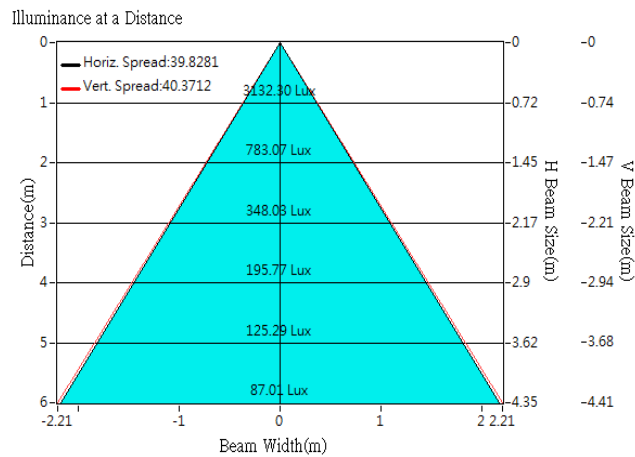



## Optical Characteristics

|                   |                              |                       |
|-------------------|------------------------------|-----------------------|
| Model Number      | CKO-CH15-060027-4307         | <p>"H" definition</p> |
| LED               | <b>CREE CXB1816</b>          |                       |
| LES / LED Size    | Φ 12 mm                      |                       |
| FWHM (D50)        | 41°                          |                       |
| Field Angle (D10) | 68°                          |                       |
| H (distance)      | 3.65mm                       |                       |
| Dimension         | Φ =60 mm, Thickness=26.85 mm |                       |
| Luminous Flux     | 1874 lm                      |                       |
| Material          | PC / UL94V2                  |                       |

## cd/klm

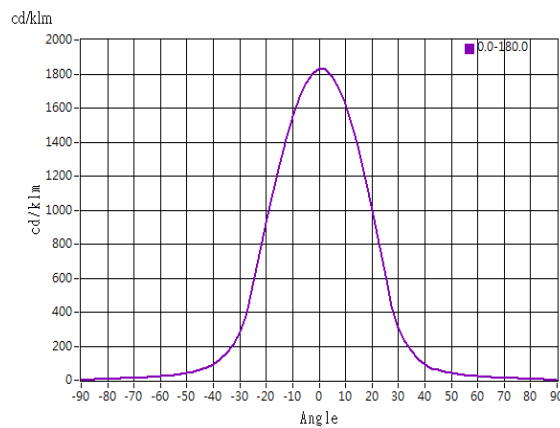

## Illuminance At Distances

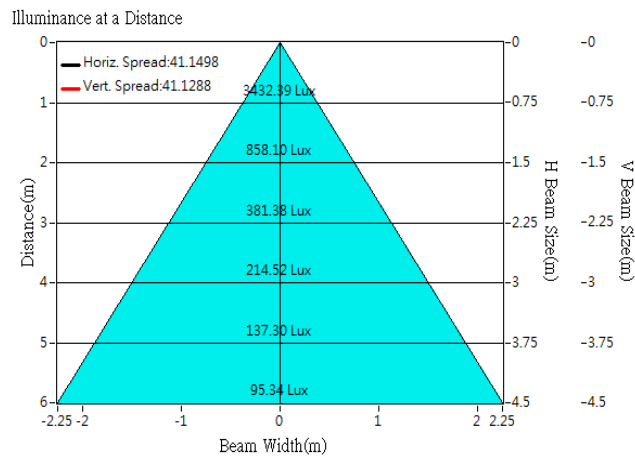



## Optical Characteristics

|                   |                              |                       |
|-------------------|------------------------------|-----------------------|
| Model Number      | CKO-CH15-060027-4307         | <p>"H" definition</p> |
| LED               | <b>CREE CXA1820</b>          |                       |
| LES / LED Size    | Φ 12 mm                      |                       |
| FWHM (D50)        | 42°                          |                       |
| Field Angle (D10) | 69°                          |                       |
| H (distance)      | 3.65mm                       |                       |
| Dimension         | Φ =60 mm, Thickness=26.85 mm |                       |
| Luminous Flux     | 2453 lm                      |                       |
| Material          | PC / UL94V2                  |                       |

## cd/klm

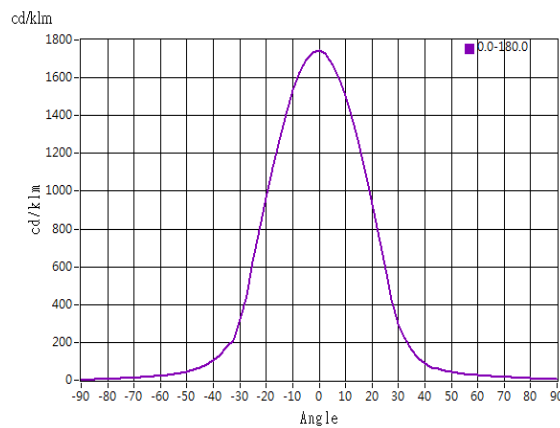

## Illuminance At Distances

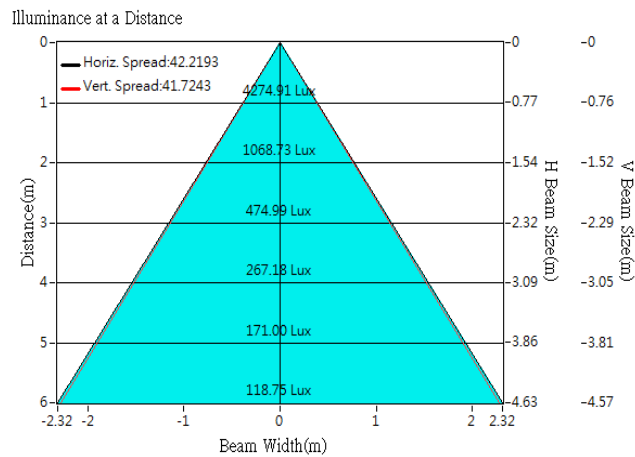



## Optical Characteristics

|                   |                              |                  |                       |
|-------------------|------------------------------|------------------|-----------------------|
| Model Number      | CKO-CH15-060027-4307         |                  | <p>"H" definition</p> |
| LED               | <b>CREE CXB1820</b>          |                  |                       |
| LES / LED Size    | Φ 12 mm                      |                  |                       |
| FWHM (D50)        | 42°                          |                  |                       |
| Field Angle (D10) | 70°                          |                  |                       |
| H (distance)      | 3.65mm                       |                  |                       |
| Dimension         | Φ =60 mm, Thickness=26.85 mm |                  |                       |
| Luminous Flux     | 2333 lm                      | Measured @ 19.6W |                       |
| Material          | PC / UL94V2                  |                  |                       |

## cd/klm

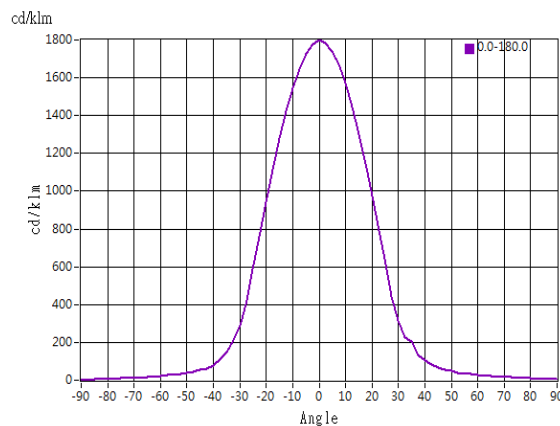

## Illuminance At Distances

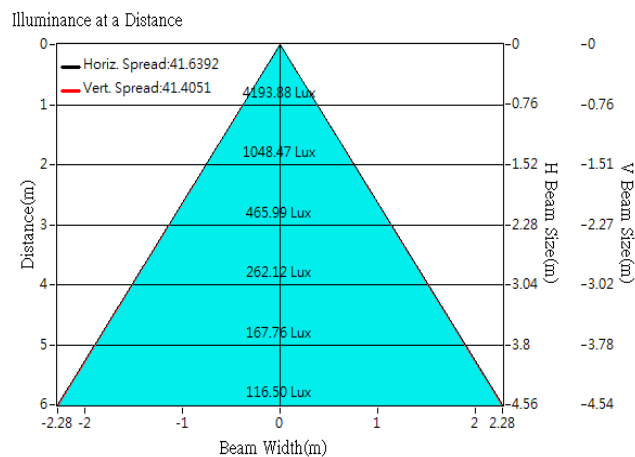



## Optical Characteristics

|                   |                                |  |
|-------------------|--------------------------------|--|
| Model Number      | CKO-CH15-060027-4307           | <p>"H" definition</p> <p>LES<br/>CoB<br/>"H" mm (distance)</p> |
| LED               | <b>CREE CMA1825</b>            |  |
| LES / LED Size    | Φ 12 mm                        |  |
| FWHM (D50)        | 42°                            |  |
| Field Angle (D10) | 74°                            |  |
| H (distance)      | 3.65mm                         |  |
| Dimension         | Φ =60 mm, Thickness=26.85 mm   |  |
| Luminous Flux     | 2858 lm      Measured @ 25.2 W |  |
| Material          | PC / UL94V2                    |  |

## cd/klm

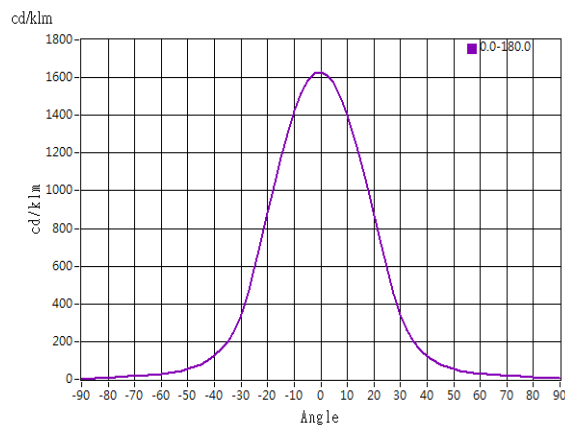

## Illuminance At Distances

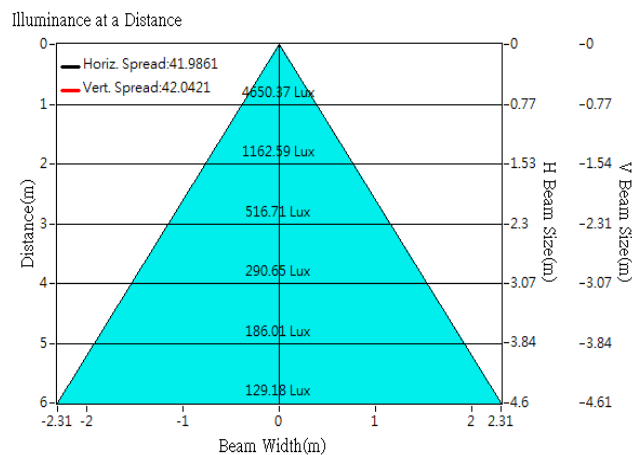

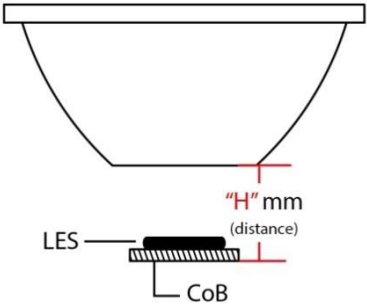

## Optical Characteristics

|                   |                               |  |
|-------------------|-------------------------------|--|
| Model Number      | CKO-CH15-060027-4307          | <p>"H" definition</p>  |
| LED               | <b>CREE CXA1850</b>           |  |
| LES / LED Size    | Φ 12 mm                       |  |
| FWHM (D50)        | 41°                           |  |
| Field Angle (D10) | 69°                           |  |
| H (distance)      | 3.65mm                        |  |
| Dimension         | Φ =60 mm, Thickness=26.85 mm  |  |
| Luminous Flux     | 4209 lm      Measured @ 48.3W |  |
| Material          | PC / UL94V2                   |  |

## cd/klm

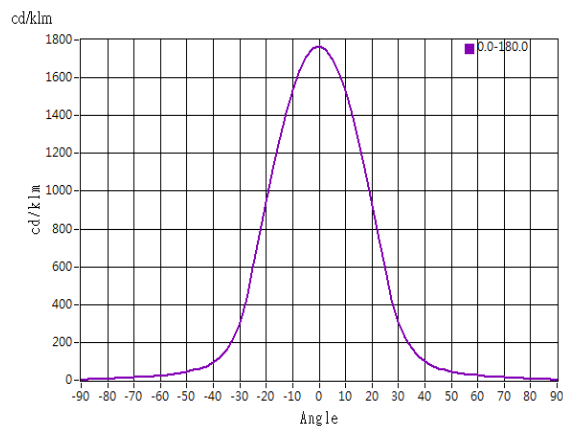

## Illuminance At Distances

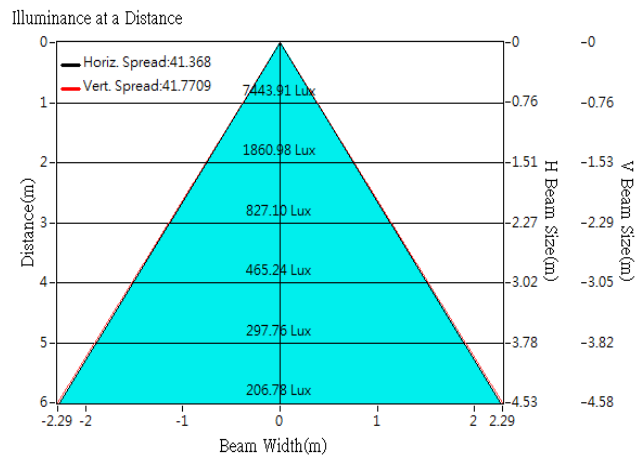



## Optical Characteristics

|                   |                                |                       |
|-------------------|--------------------------------|-----------------------|
| Model Number      | CKO-CH15-060027-4307           | <p>"H" definition</p> |
| LED               | <b>CREE CXA1830</b>            |                       |
| LES / LED Size    | Φ 14 mm                        |                       |
| FWHM (D50)        | 42°                            |                       |
| Field Angle (D10) | 71°                            |                       |
| H (distance)      | 3.65mm                         |                       |
| Dimension         | Φ =60 mm, Thickness=26.85 mm   |                       |
| Luminous Flux     | 2778 lm      Measured @ 28.9 W |                       |
| Material          | PC / UL94V2                    |                       |

## cd/klm

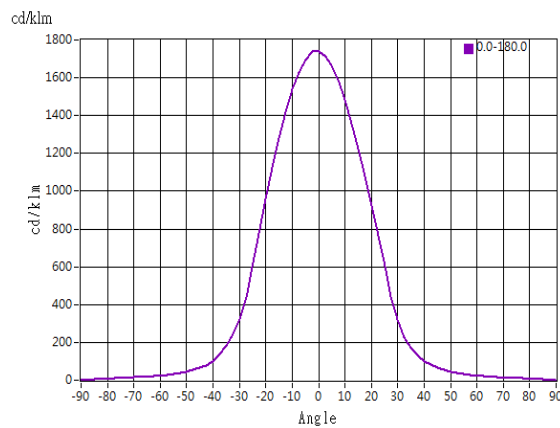

## Illuminance At Distances

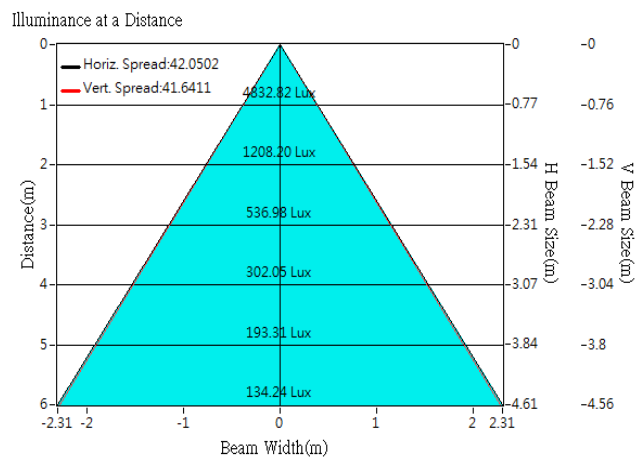



## Optical Characteristics

|                   |                                |  |
|-------------------|--------------------------------|--|
| Model Number      | CKO-CH15-060027-4307           | <p>"H" definition</p> <p>LES<br/>CoB</p> |
| LED               | <b>CREE CXB1830</b>            |  |
| LES / LED Size    | Φ 14 mm                        |  |
| FWHM (D50)        | 42°                            |  |
| Field Angle (D10) | 71°                            |  |
| H (distance)      | 3.65mm                         |  |
| Dimension         | Φ =60 mm, Thickness=26.85 mm   |  |
| Luminous Flux     | 3457 lm      Measured @ 28.4 W |  |
| Material          | PC / UL94V2                    |  |

## cd/klm

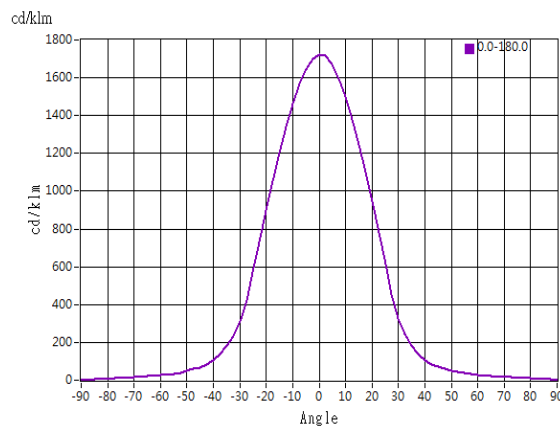

## Illuminance At Distances

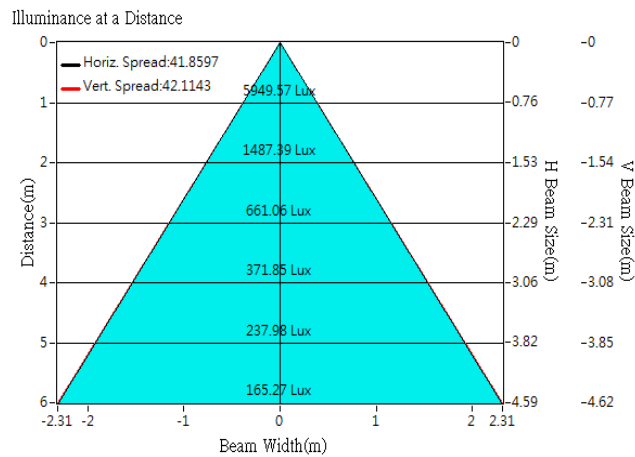



## Optical Characteristics

|                   |                              |                   |                       |
|-------------------|------------------------------|-------------------|-----------------------|
| Model Number      | CKO-CH15-060027-4307         |                   | <p>"H" definition</p> |
| LED               | <b>CREE CMA1840</b>          |                   |                       |
| LES / LED Size    | Φ 14 mm                      |                   |                       |
| FWHM (D50)        | 43°                          |                   |                       |
| Field Angle (D10) | 76°                          |                   |                       |
| H (distance)      | 3.65mm                       |                   |                       |
| Dimension         | Φ =60 mm, Thickness=26.85 mm |                   |                       |
| Luminous Flux     | 4483 lm                      | Measured @ 38.5 W |                       |
| Material          | PC / UL94V2                  |                   |                       |

## cd/klm

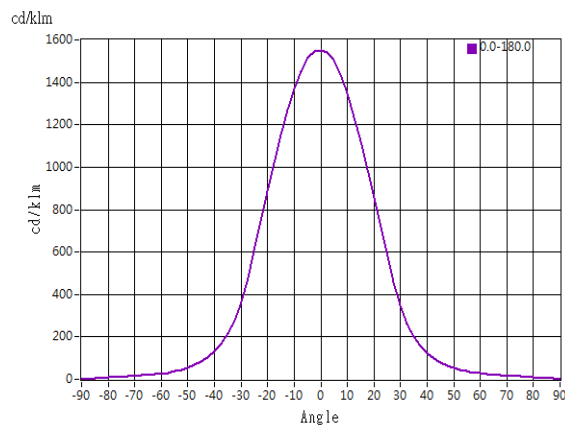

## Illuminance At Distances

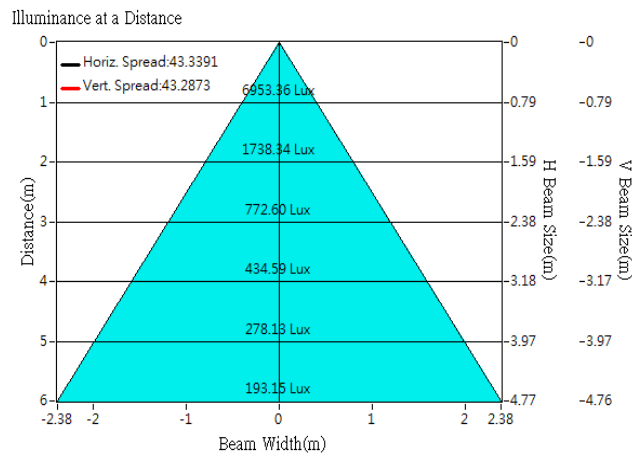



## Optical Characteristics

|                   |                                |  |
|-------------------|--------------------------------|--|
| Model Number      | CKO-CH15-060027-4307           | <p>"H" definition</p> <p>LES<br/>CoB</p> |
| LED               | <b>CREE CMT1922</b>            |  |
| LES / LED Size    | Φ 14.5 mm                      |  |
| FWHM (D50)        | 43°                            |  |
| Field Angle (D10) | 76°                            |  |
| H (distance)      | 3.65mm                         |  |
| Dimension         | Φ =60 mm, Thickness=26.85 mm   |  |
| Luminous Flux     | 2514 lm      Measured @ 21.6 W |  |
| Material          | PC / UL94V2                    |  |

## cd/klm

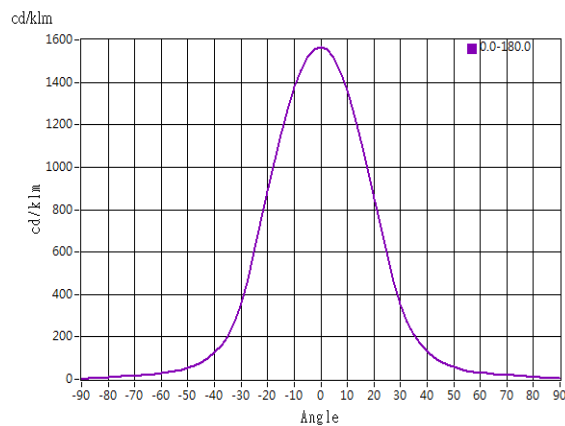

## Illuminance At Distances

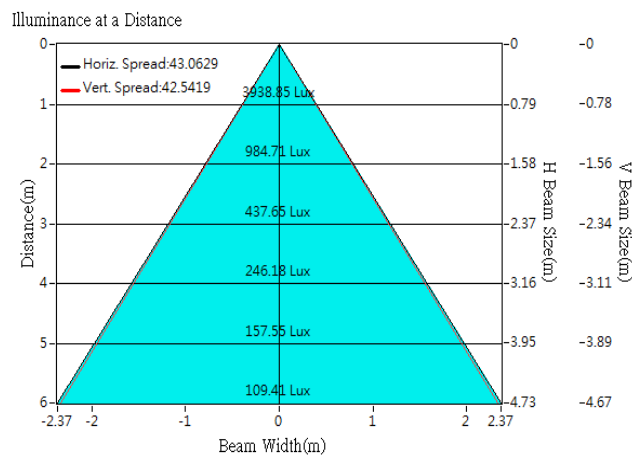



## Optical Characteristics

|                   |                              |                       |
|-------------------|------------------------------|-----------------------|
| Model Number      | CKO-CH15-060027-4307         | <p>"H" definition</p> |
| LED               | <b>CREE CMT1925</b>          |                       |
| LES / LED Size    | Φ 14.5 mm                    |                       |
| FWHM (D50)        | 44°                          |                       |
| Field Angle (D10) | 79°                          |                       |
| H (distance)      | 3.65mm                       |                       |
| Dimension         | Φ =60 mm, Thickness=26.85 mm |                       |
| Luminous Flux     | 2944 lm                      |                       |
| Material          | PC / UL94V2                  |                       |

## cd/klm

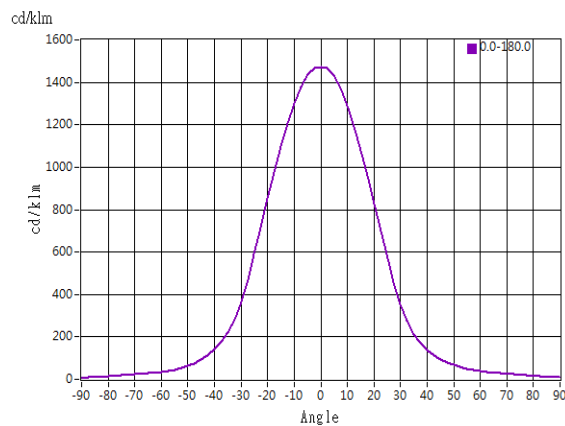

## Illuminance At Distances

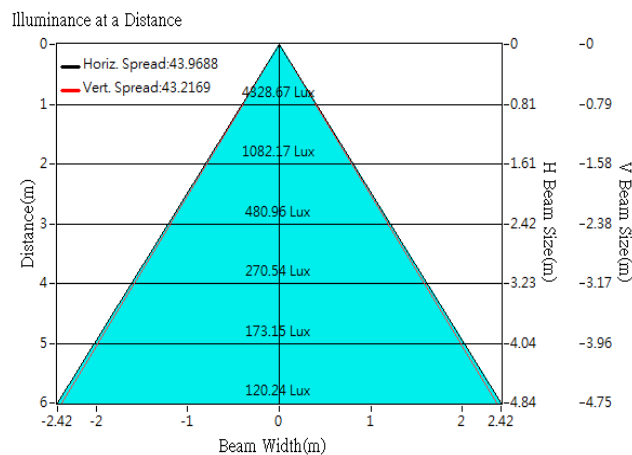



## Optical Characteristics

|                   |                              |                   |  |
|-------------------|------------------------------|-------------------|--|
| Model Number      | CKO-CH15-060027-4307         |                   | <p>"H" definition</p> <p>LES<br/>CoB</p> |
| LED               | <b>CREE CMT1930</b>          |                   |  |
| LES / LED Size    | Φ 14.5 mm                    |                   |  |
| FWHM (D50)        | 43°                          |                   |  |
| Field Angle (D10) | 77°                          |                   |  |
| H (distance)      | 3.65mm                       |                   |  |
| Dimension         | Φ =60 mm, Thickness=26.85 mm |                   |  |
| Luminous Flux     | 3312 lm                      | Measured @ 29.1 W |  |
| Material          | PC / UL94V2                  |                   |  |

## cd/klm

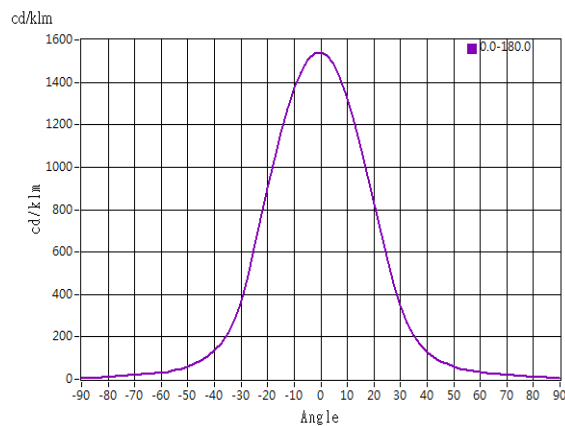

## Illuminance At Distances

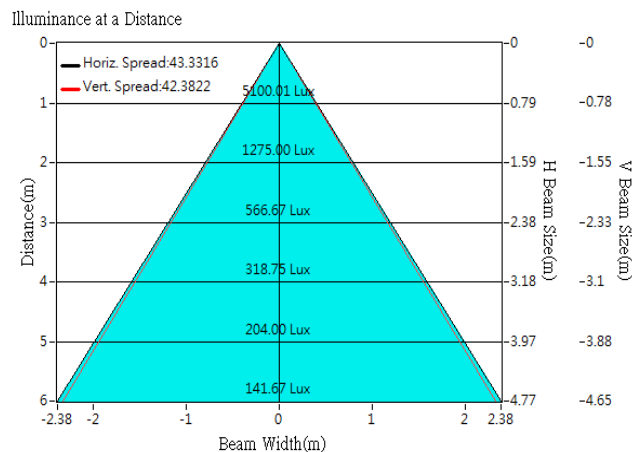

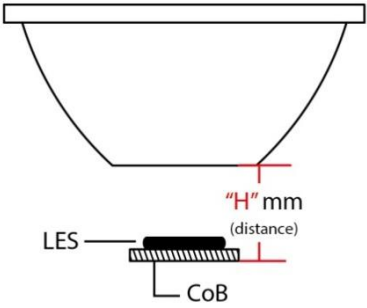

## Optical Characteristics

|                   |                                |  |
|-------------------|--------------------------------|--|
| Model Number      | CKO-CH15-060027-4307           | <p>"H" definition</p>  |
| LED               | <b>CREE CMT1945</b>            |  |
| LES / LED Size    | Φ 14.5 mm                      |  |
| FWHM (D50)        | 43°                            |  |
| Field Angle (D10) | 77°                            |  |
| H (distance)      | 3.65mm                         |  |
| Dimension         | Φ =60 mm, Thickness=26.85 mm   |  |
| Luminous Flux     | 4781 lm      Measured @ 44.2 W |  |
| Material          | PC / UL94V2                    |  |

## cd/klm

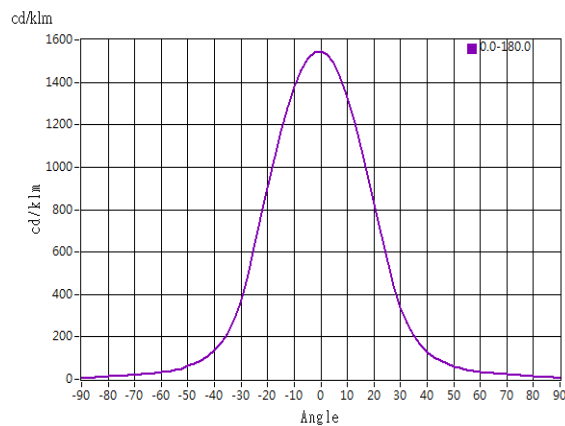

## Illuminance At Distances

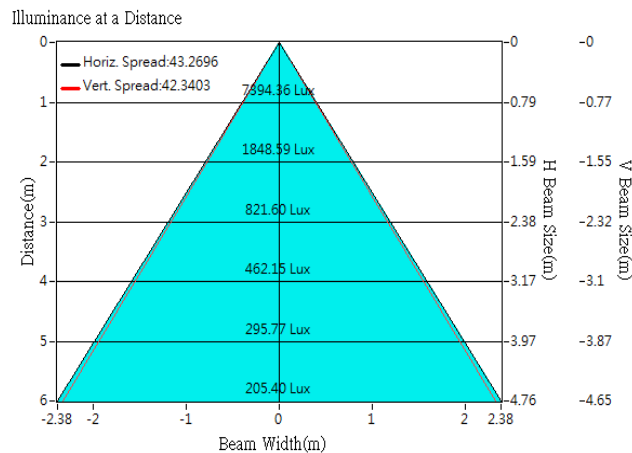

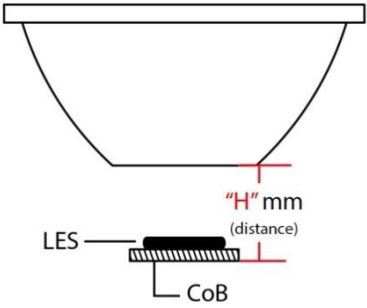

## Optical Characteristics

|                   |                              |                   |  |
|-------------------|------------------------------|-------------------|--|
| Model Number      | CKO-CH15-060027-4307         |                   | <p>"H" definition</p>  |
| LED               | <b>CREE CXA2520</b>          |                   |  |
| LES / LED Size    | Φ 19 mm                      |                   |  |
| FWHM (D50)        | 46°                          |                   |  |
| Field Angle (D10) | 83°                          |                   |  |
| H (distance)      | 3.65mm                       |                   |  |
| Dimension         | Φ =60 mm, Thickness=26.85 mm |                   |  |
| Luminous Flux     | 1892 lm                      | Measured @ 20.2 W |  |
| Material          | PC / UL94V2                  |                   |  |

## cd/klm

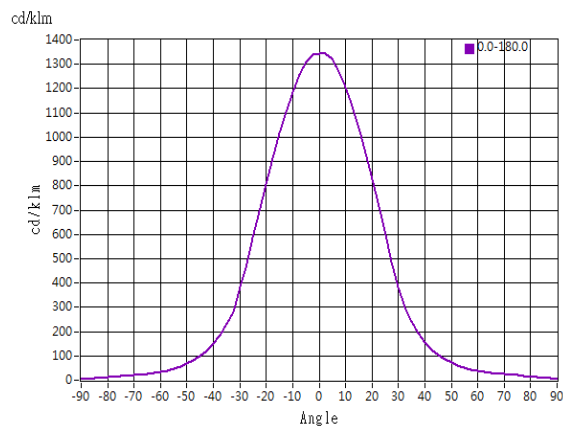

## Illuminance At Distances

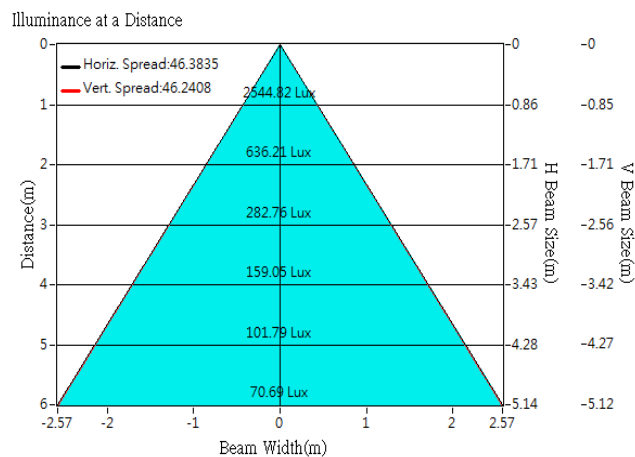



## Optical Characteristics

|                   |                              |                       |
|-------------------|------------------------------|-----------------------|
| Model Number      | CKO-CH15-060027-4307         | <p>"H" definition</p> |
| LED               | <b>CREE CXA2530</b>          |                       |
| LES / LED Size    | Φ 19 mm                      |                       |
| FWHM (D50)        | 45°                          |                       |
| Field Angle (D10) | 78°                          |                       |
| H (distance)      | 3.65mm                       |                       |
| Dimension         | Φ =60 mm, Thickness=26.85 mm |                       |
| Luminous Flux     | 2746 lm                      |                       |
| Material          | PC / UL94V2                  |                       |

## cd/klm

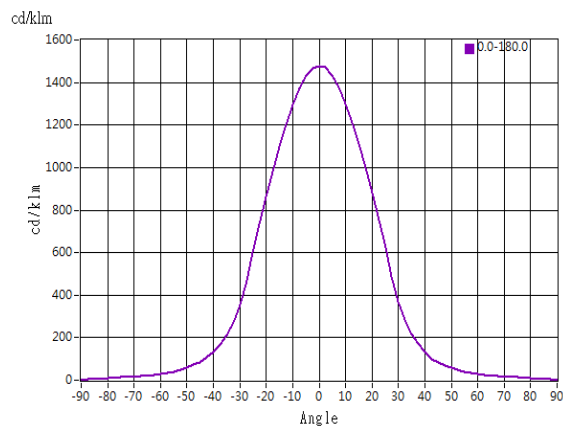

## Illuminance At Distances

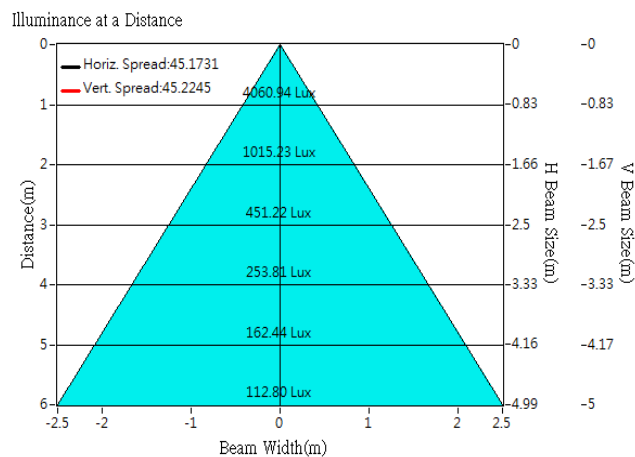



## Optical Characteristics

|                   |                                |                       |
|-------------------|--------------------------------|-----------------------|
| Model Number      | CKO-CH15-060027-4307           | <p>"H" definition</p> |
| LED               | <b>CREE CXB2530</b>            |                       |
| LES / LED Size    | Φ 19 mm                        |                       |
| FWHM (D50)        | 48°                            |                       |
| Field Angle (D10) | 86°                            |                       |
| H (distance)      | 3.65mm                         |                       |
| Dimension         | Φ =60 mm, Thickness=26.85 mm   |                       |
| Luminous Flux     | 3295 lm      Measured @ 27.9 W |                       |
| Material          | PC / UL94V2                    |                       |

## cd/klm

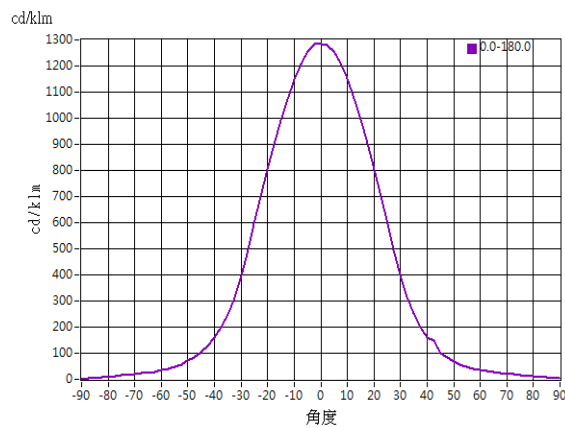

## Illuminance At Distances

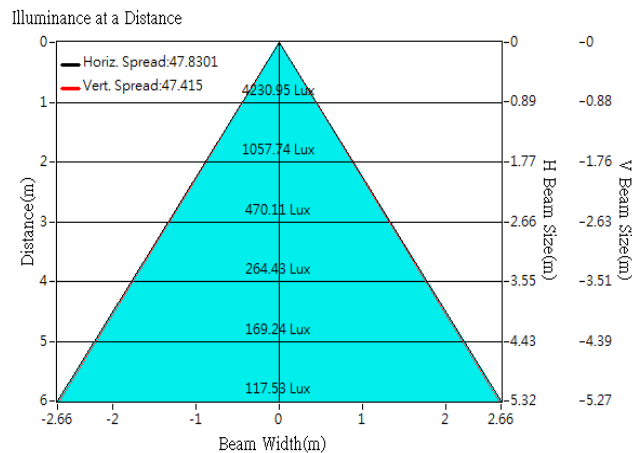



## Optical Characteristics

|                   |                                |                       |
|-------------------|--------------------------------|-----------------------|
| Model Number      | CKO-CH15-060027-4307           | <p>"H" definition</p> |
| LED               | <b>CREE CXA2540</b>            |                       |
| LES / LED Size    | Φ 19 mm                        |                       |
| FWHM (D50)        | 47°                            |                       |
| Field Angle (D10) | 84°                            |                       |
| H (distance)      | 3.65mm                         |                       |
| Dimension         | Φ =60 mm, Thickness=26.85 mm   |                       |
| Luminous Flux     | 2763 lm      Measured @ 40.3 W |                       |
| Material          | PC / UL94V2                    |                       |

## cd/klm

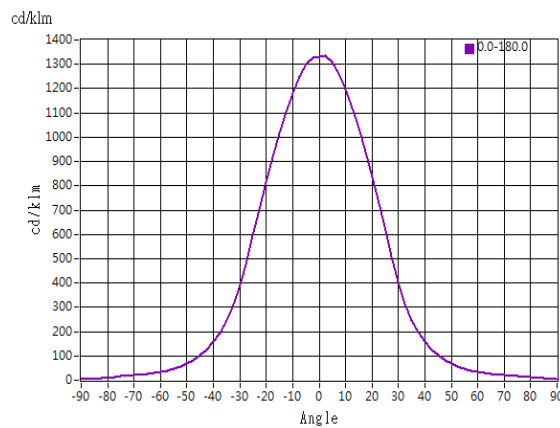

## Illuminance At Distances

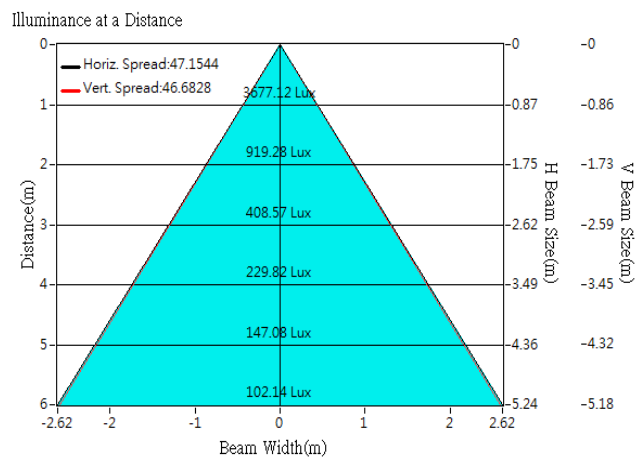



## Optical Characteristics

|                   |                              |                 |                       |
|-------------------|------------------------------|-----------------|-----------------------|
| Model Number      | CKO-CH15-060027-4307         |                 | <p>"H" definition</p> |
| LED               | <b>CREE CXB2540</b>          |                 |                       |
| LES / LED Size    | Φ 19 mm                      |                 |                       |
| FWHM (D50)        | 48°                          |                 |                       |
| Field Angle (D10) | 86°                          |                 |                       |
| H (distance)      | 3.65mm                       |                 |                       |
| Dimension         | Φ =60 mm, Thickness=26.85 mm |                 |                       |
| Luminous Flux     | 4283 lm                      | Measured @ 38 W |                       |
| Material          | PC / UL94V2                  |                 |                       |

## cd/klm

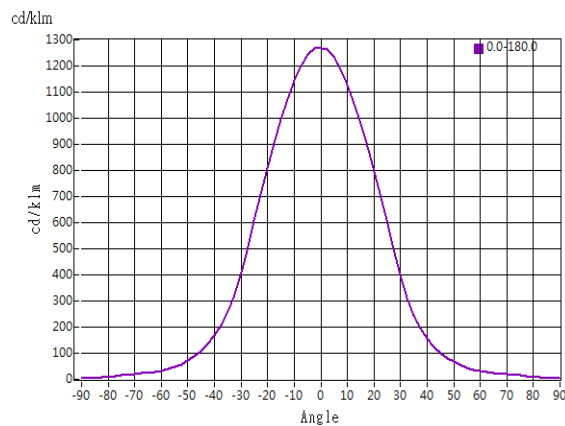

## Illuminance At Distances

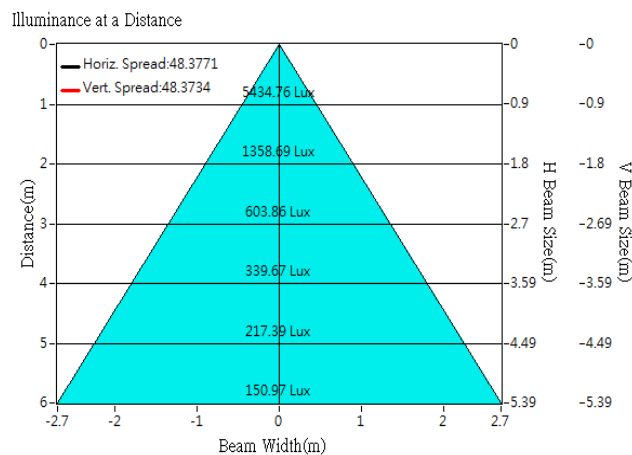



## Optical Characteristics

|                   |                              |                   |                       |
|-------------------|------------------------------|-------------------|-----------------------|
| Model Number      | CKO-CH15-060027-4307         |                   | <p>"H" definition</p> |
| LED               | <b>CREE CMA2550</b>          |                   |                       |
| LES / LED Size    | Φ 19 mm                      |                   |                       |
| FWHM (D50)        | 50°                          |                   |                       |
| Field Angle (D10) | 88°                          |                   |                       |
| H (distance)      | 3.65mm                       |                   |                       |
| Dimension         | Φ =60 mm, Thickness=26.85 mm |                   |                       |
| Luminous Flux     | 5201 lm                      | Measured @ 43.1 W |                       |
| Material          | PC / UL94V2                  |                   |                       |

## cd/klm

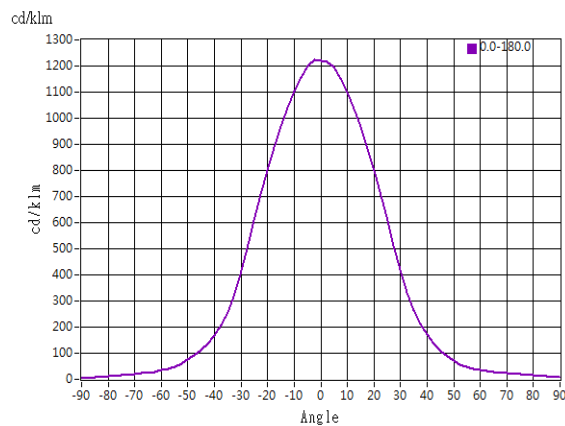

## Illuminance At Distances

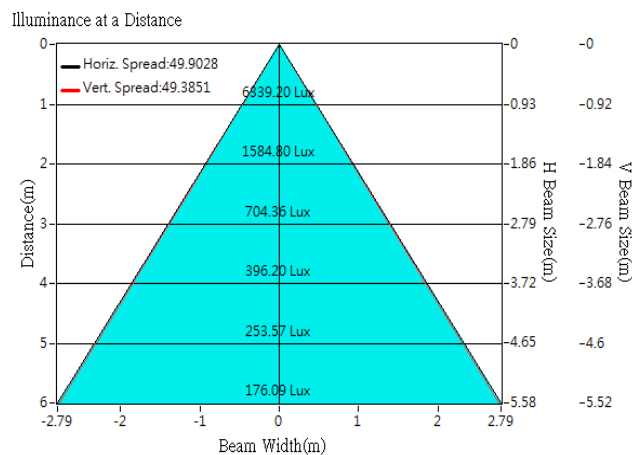



## Lens Accessories - CoB Holder

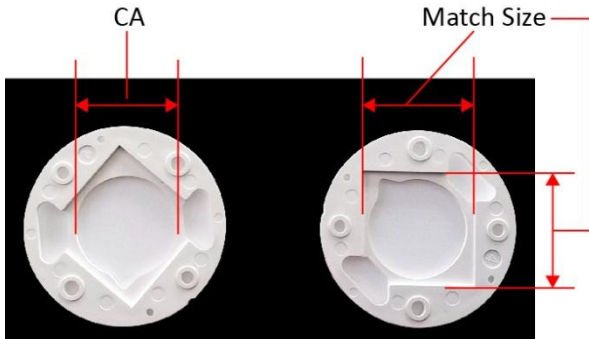

Example of LES Area & LED Size Dimension Locations

| Product Model        | Match Size (mm) | CA (mm) | Material | Applicability |
|----------------------|-----------------|---------|----------|---------------|
| CKO-HC13-131307-6411 | 13.6 x 13.6     | Φ 7.8   | PBT      | CREE CXA 13XX |
| CKO-HC13-161610-6412 | 16.1 x 16.1     | Φ 10.8  | PBT      | CREE CXA 15XX |
| CKO-HC13-181816-6413 | 18.1 x 18.1     | Φ 16.4  | PBT      | CREE CXA 18XX |
| CKO-HC13-242421-6414 | 24.1 x 24.1     | Φ 21.3  | PBT      | CREE CXA 25XX |
| CKO-HC13-272725-6415 | 27.6 x 27.6     | Φ 25.3  | PBT      | CREE CXA 30XX |