



## Product Model Number

CKO-CH15-060027-4307

### ✓ Model Number Definitions

**CKO-XXXX-XXXXXX-XXXX**



- A. Chun Kuang Optics Corp. Product
- B. Product Type: product abbreviation  
Ex:  
CH→CoB High Intensity  
CC→CoB Compact  
CS→Soft Shading for CoB LED  
HC→Holder for CoB LED

- C. Identity Code
- D. Lens / Fixture Size  
Ex: 075026=Φ75mm / Thickness=26mm (round up)
- C. Serial Numbers

The lens datasheet is applicable for **TRIDONIC LED**, that manufactured by Chun Kuang Optics Corp.

### ✓ Dimensions (mm) : Φ60 x 26.85

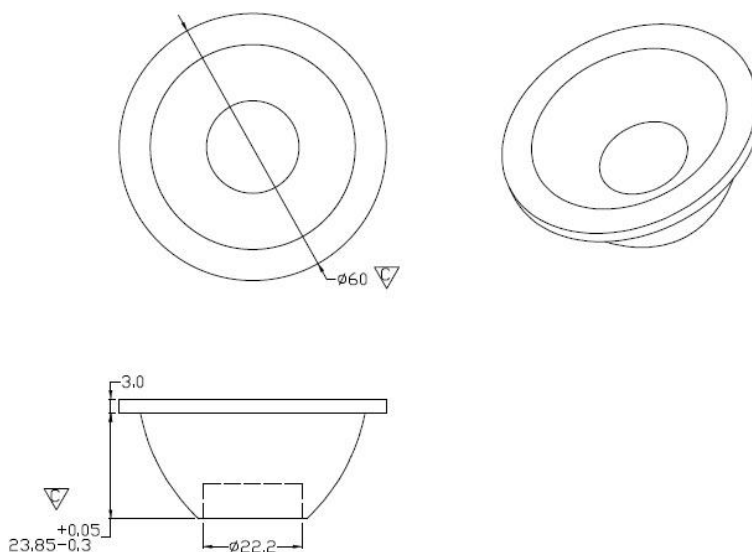

▽:Critical Dimension





## Optical Characteristics

Model Number	CKO-CH15-060027-4307		
LED	SLE G7 09mm 1200lm 940 R ADV		
LES / LED Size	Φ 9 mm		
FWHM (D50)	37°		
Field Angle (D10)	69°		
H (distance)	3.65mm		
Dimension	Φ =60 mm, Thickness=26.85 mm		
Luminous Flux	1475 lm	Measured @ 12.3 W	
Material	PC / UL94V2		

## cd/klm

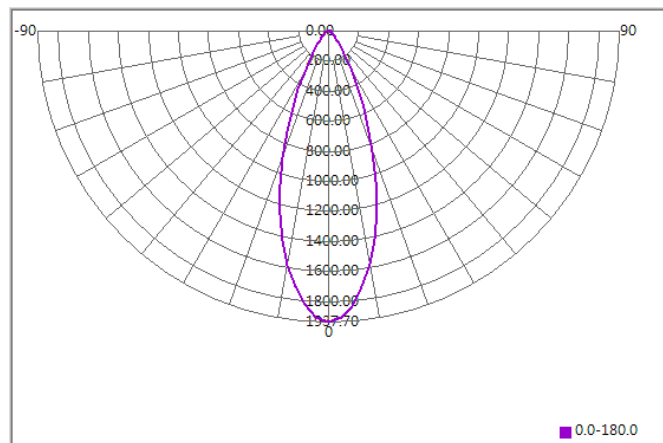

## Illuminance At Distances

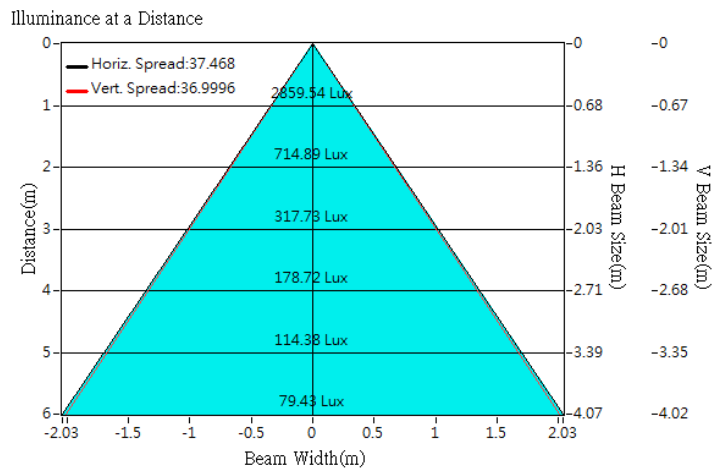



## Optical Characteristics

Model Number	CKO-CH15-060027-4307		<p>"H" definition</p>
LED	SLE G7 13mm 3000lm 930 R ADV		
LES / LED Size	Φ 13 mm		
FWHM (D50)	41°		
Field Angle (D10)	74°		
H (distance)	3.65mm		
Dimension	Φ =60 mm, Thickness=26.85 mm		
Luminous Flux	1479 lm	Measured @ 11.7 W	
Material	PC / UL94V2		

## cd/klm

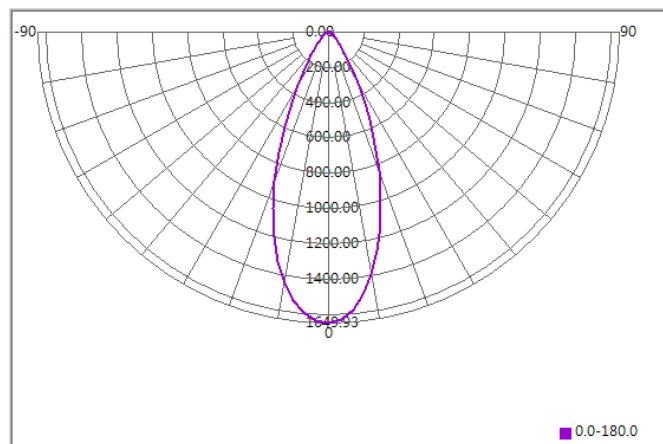

## Illuminance At Distances

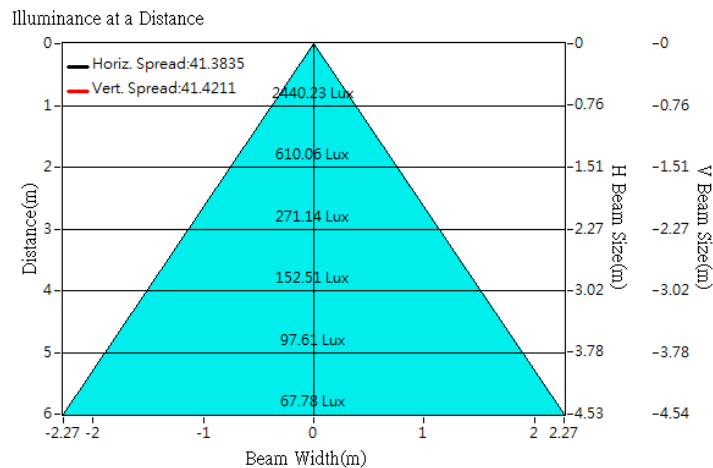



## Optical Characteristics

Model Number	CKO-CH15-060027-4307		<p>"H" definition</p>
LED	SLE G7 15mm 4000lm 840 R ADV		
LES / LED Size	Φ 15 mm		
FWHM (D50)	44°		
Field Angle (D10)	78°		
H (distance)	3.65mm		
Dimension	Φ =60 mm, Thickness=26.85 mm		
Luminous Flux	4105lm	Measured @ 32.8 W	
Material	PC / UL94V2		

## cd/klm

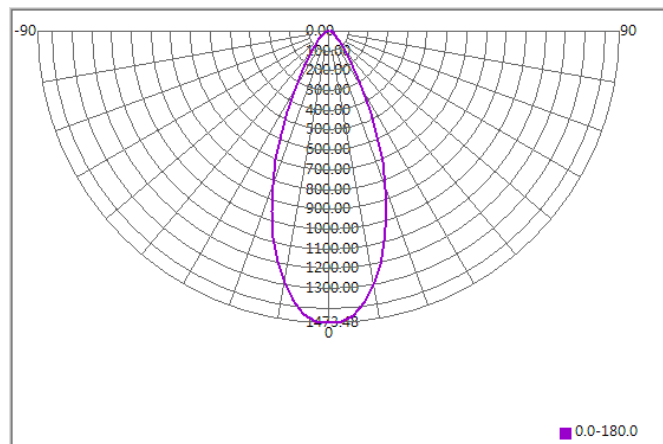

## Illuminance At Distances

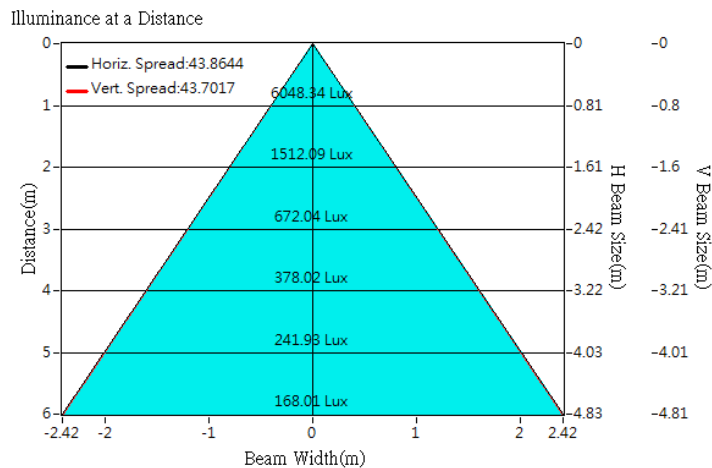



## Optical Characteristics

Model Number	CKO-CH15-060027-4307		<p>"H" definition</p>
LED	SLE G7 17mm 5000lm 830 R ADV		
LES / LED Size	Φ 17 mm		
FWHM (D50)	46°		
Field Angle (D10)	82°		
H (distance)	3.65mm		
Dimension	Φ =60 mm, Thickness=26.85 mm		
Luminous Flux	4752 lm	Measured @ 38.5 W	
Material	PC / UL94V2		

## cd/klm

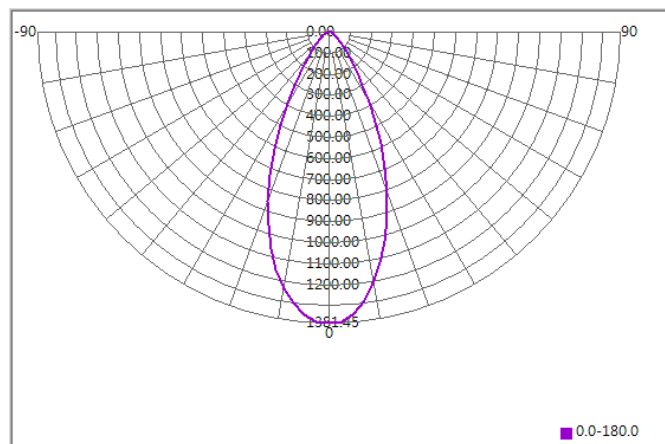

## Illuminance At Distances

