



Product Model Number

CKO-CH15-060027-4350

✓ Model Number Definitions

CKO-XXXX-XXXXXX-XXXX



- A. Chun Kuang Optics Corp. Product
- B. Product Type: product abbreviation
Ex:
MX→Multi 33 in 1
SW→Single Wall Washer
CS→Soft Shading for CoB LED
HC→Holder for CoB LED

- C. Identity Code
- D. Lens / Fixture Size
Ex: 025014=Φ25mm / Thickness=13.5mm (round up)
- C. Serial Numbers

The lens datasheet is applicable for **Cree LED**, that manufactured by Chun Kuang Optics Corp.

✓ Dimensions (mm) : Φ60x26.85

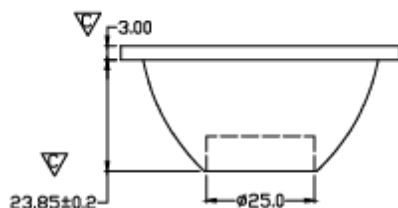
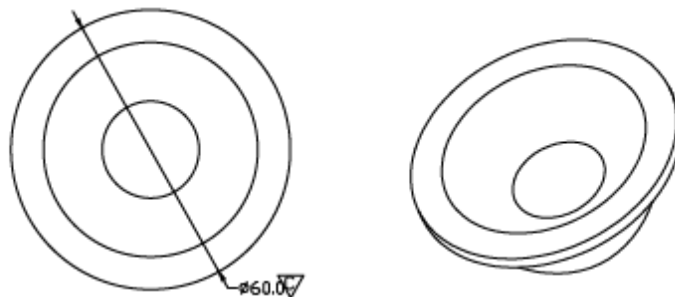

▽:Critical Dimension



✓ Optical Characteristics – Angle Performances

| Cree | LED LES (mm) | FWHM (degrees) | Field Angle (degrees) |
|---------|--------------|----------------|-----------------------|
| CXA1507 | Φ9 | 55° | 102° |
| CXB1507 | Φ9 | 55° | 101° |
| CXA1510 | Φ9 | 55° | 97° |
| CXA1512 | Φ9 | 55° | 102° |
| CXB1512 | Φ9 | 55° | 102° |
| CMA1516 | Φ9 | 55° | 101° |
| CXB1520 | Φ9 | 53° | 100° |
| CMT1407 | Φ9.8 | 53° | 100° |
| CMT1420 | Φ9.8 | 52° | 98° |
| CXA1816 | Φ12 | 57° | 103° |
| CXB1816 | Φ12 | 55° | 100° |
| CXA1820 | Φ12 | 55° | 102° |
| CXB1820 | Φ12 | 56° | 103° |
| CMA1825 | Φ12 | 55° | 101° |
| CXA1830 | Φ14 | 56° | 102° |
| CXB1830 | Φ14 | 56° | 103° |
| CMA1840 | Φ14 | 57° | 104° |
| CMT1922 | Φ14.5 | 56° | 103° |
| CMT1925 | Φ14.5 | 53° | 102° |
| CMT1930 | Φ14.5 | 55° | 104° |
| CMT1945 | Φ14.5 | 55° | 103° |



Optical Characteristics

| | | |
|-------------------|------------------------------|--|
| Model Number | CKO-CH15-060027-4350 | <p>"H" definition</p> <p>LES CoB</p> |
| LED | CXA1507 | |
| LES / LED Size | Φ 9 mm | |
| FWHM (D50) | 55° | |
| Field Angle (D10) | 102° | |
| H (distance) | 3.65 mm | |
| Dimension | Φ =60 mm, Thickness=26.85 mm | |
| Luminous Flux | 620 lm | |
| Material | PC / UL94V2 | |

cd/klm

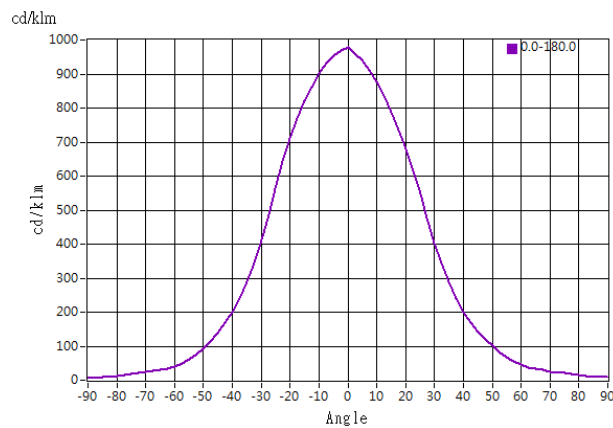

Illuminance At Distances

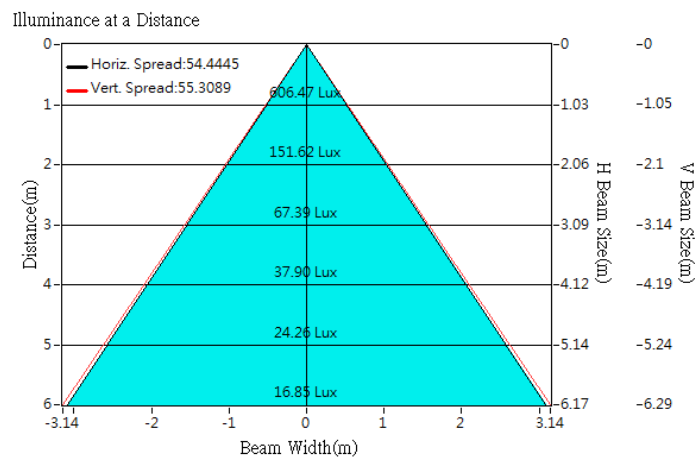



Optical Characteristics

| | | | |
|-------------------|------------------------------|------------------|-----------------------|
| Model Number | CKO-CH15-060027-4350 | | <p>"H" definition</p> |
| LED | CXB1507 | | |
| LES / LED Size | Φ 9 mm | | |
| FWHM (D50) | 55° | | |
| Field Angle (D10) | 101° | | |
| H (distance) | 3.65 mm | | |
| Dimension | Φ =60 mm, Thickness=26.85 mm | | |
| Luminous Flux | 782 lm | Measured @ 7.2 W | |
| Material | PC / UL94V2 | | |

cd/klm

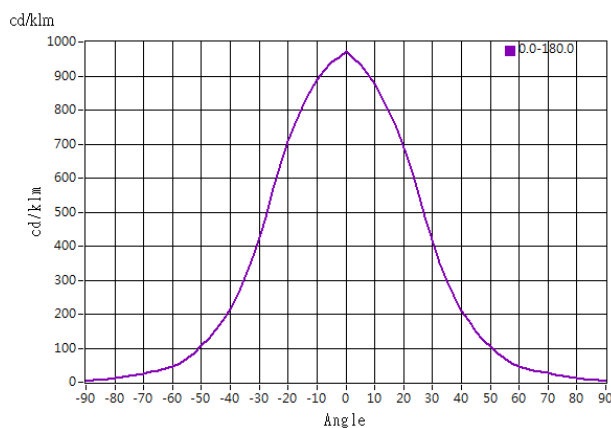

Illuminance At Distances

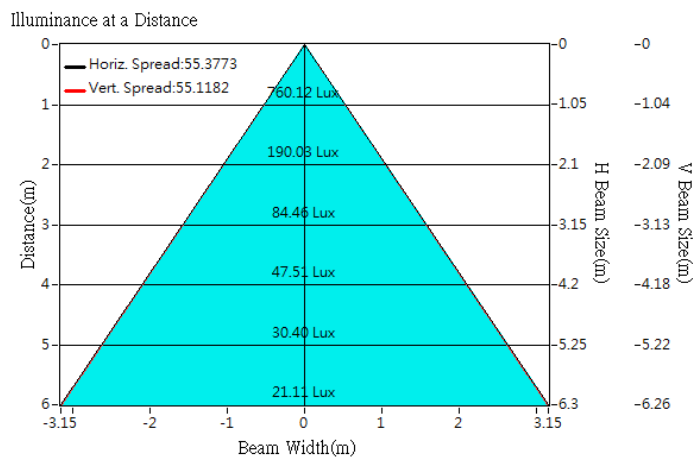

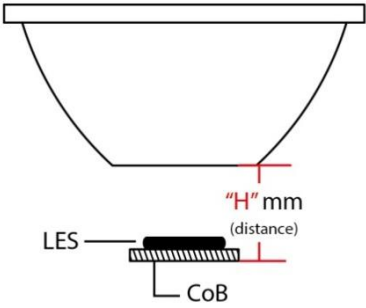

Optical Characteristics

| | | |
|-------------------|--------------------------------|--|
| Model Number | CKO-CH15-060027-4350 | <p>"H" definition</p>  |
| LED | CXA1512 | |
| LES / LED Size | Φ 9 mm | |
| FWHM (D50) | 55° | |
| Field Angle (D10) | 102° | |
| H (distance) | 3.65 mm | |
| Dimension | Φ =60 mm, Thickness=26.85 mm | |
| Luminous Flux | 1139 lm Measured @ 13.5 W | |
| Material | PC / UL94V2 | |

cd/klm

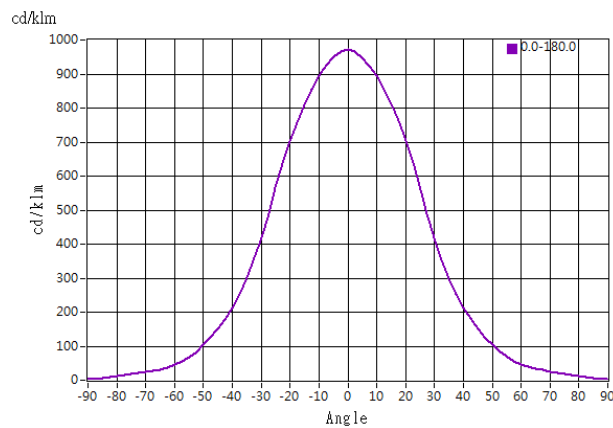

Illuminance At Distances

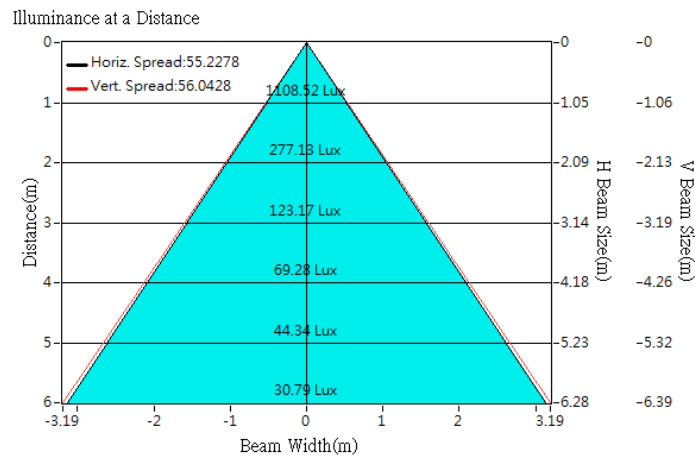

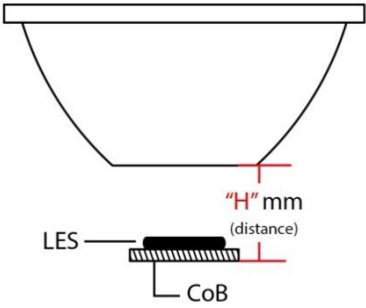

Optical Characteristics

| | | |
|-------------------|--------------------------------|--|
| Model Number | CKO-CH15-060027-4350 | <p>"H" definition</p>  |
| LED | CXB1512 | |
| LES / LED Size | Φ 9 mm | |
| FWHM (D50) | 55° | |
| Field Angle (D10) | 102° | |
| H (distance) | 3.65 mm | |
| Dimension | Φ =60 mm, Thickness=26.85 mm | |
| Luminous Flux | 1338 lm Measured @ 12.1 W | |
| Material | PC / UL94V2 | |

cd/klm

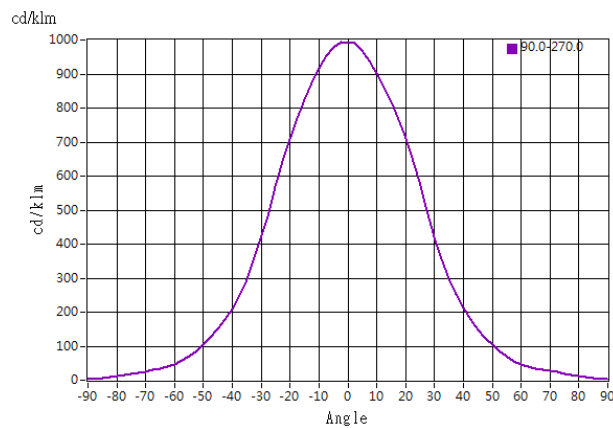

Illuminance At Distances

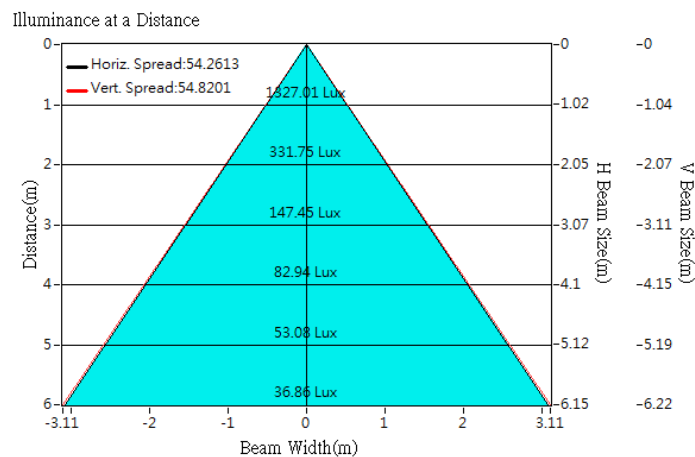



Optical Characteristics

| | | |
|-------------------|------------------------------|-----------------------|
| Model Number | CKO-CH15-060027-4350 | <p>"H" definition</p> |
| LED | CMA1516 | |
| LES / LED Size | Φ 9 mm | |
| FWHM (D50) | 55° | |
| Field Angle (D10) | 101° | |
| H (distance) | 3.65 mm | |
| Dimension | Φ =60 mm, Thickness=26.85 mm | |
| Luminous Flux | 1824 lm | |
| Material | PC / UL94V2 | |

cd/klm

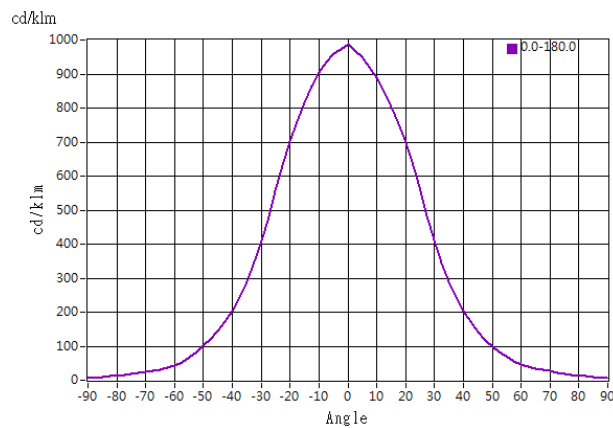

Illuminance At Distances

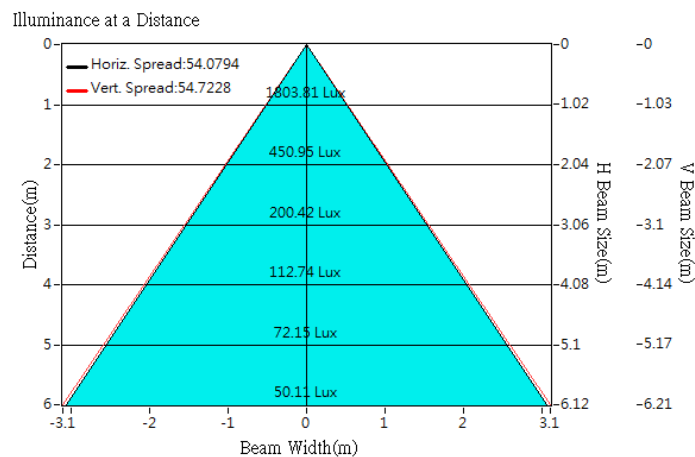



Optical Characteristics

| | | |
|-------------------|------------------------------|-----------------------|
| Model Number | CKO-CH15-060027-4350 | <p>"H" definition</p> |
| LED | CXB1520 | |
| LES / LED Size | Φ 9 mm | |
| FWHM (D50) | 53° | |
| Field Angle (D10) | 100° | |
| H (distance) | 3.65 mm | |
| Dimension | Φ =60 mm, Thickness=26.85 mm | |
| Luminous Flux | 2004 lm | |
| Material | PC / UL94V2 | |

cd/klm

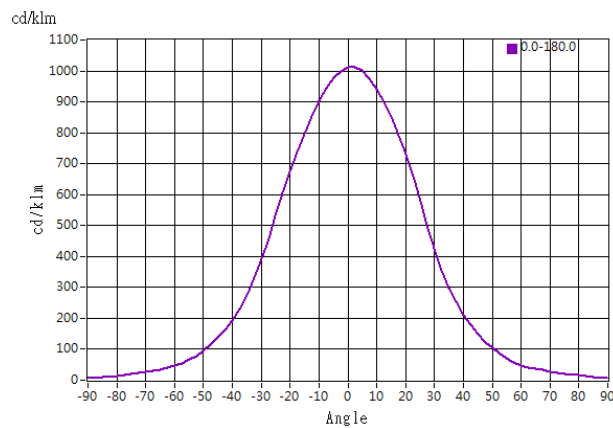

Illuminance At Distances

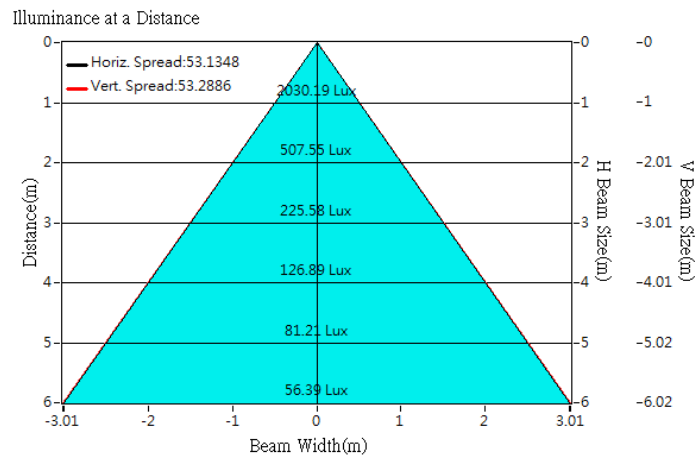



Optical Characteristics

| | | | |
|-------------------|------------------------------|---------------|-----------------------|
| Model Number | CKO-CH15-060027-4350 | | <p>"H" definition</p> |
| LED | CMT1407 | | |
| LES / LED Size | Φ 9.8 mm | | |
| FWHM (D50) | 53° | | |
| Field Angle (D10) | 100° | | |
| H (distance) | 3.65 mm | | |
| Dimension | Φ =60 mm, Thickness=26.85 mm | | |
| Luminous Flux | 818 lm | Measured @ 7W | |
| Material | PC / UL94V2 | | |

cd/klm

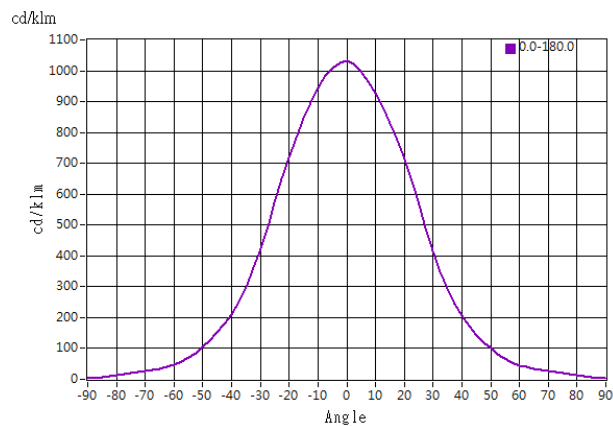

Illuminance At Distances

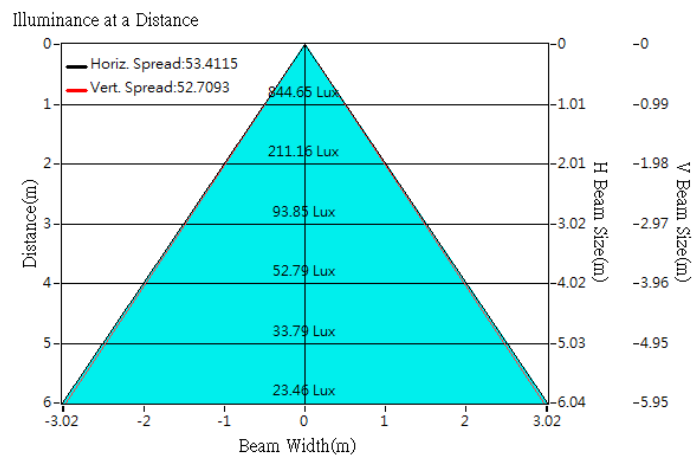



Optical Characteristics

| | | | |
|-------------------|------------------------------|-----------------|-----------------------|
| Model Number | CKO-CH15-060027-4350 | | <p>"H" definition</p> |
| LED | CMT1420 | | |
| LES / LED Size | Φ 9.8 mm | | |
| FWHM (D50) | 52° | | |
| Field Angle (D10) | 98° | | |
| H (distance) | 3.65 mm | | |
| Dimension | Φ =60 mm, Thickness=26.85 mm | | |
| Luminous Flux | 2132 lm | Measured @ 19 W | |
| Material | PC / UL94V2 | | |

cd/klm

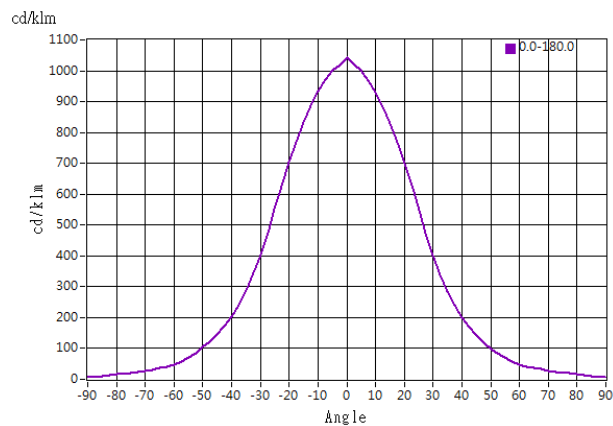

Illuminance At Distances

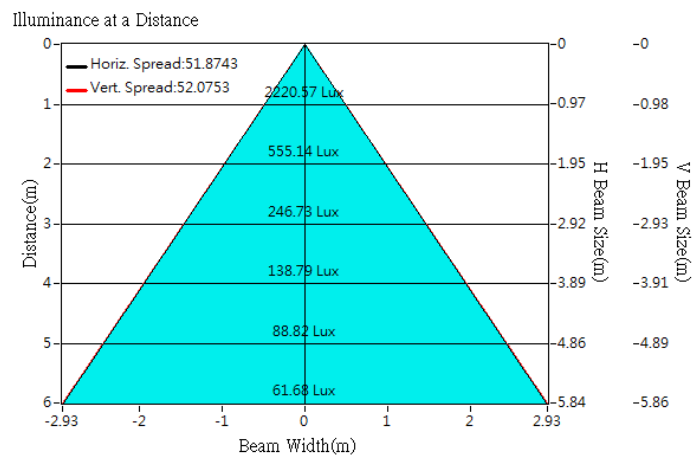



Optical Characteristics

| | | | |
|-------------------|------------------------------|-----------------|-----------------------|
| Model Number | CKO-CH15-060027-4350 | | <p>"H" definition</p> |
| LED | CXA1816 | | |
| LES / LED Size | Φ 12 mm | | |
| FWHM (D50) | 57° | | |
| Field Angle (D10) | 103° | | |
| H (distance) | 3.65 mm | | |
| Dimension | Φ =60 mm, Thickness=26.85 mm | | |
| Luminous Flux | 1444 lm | Measured @ 17 W | |
| Material | PC / UL94V2 | | |

cd/klm

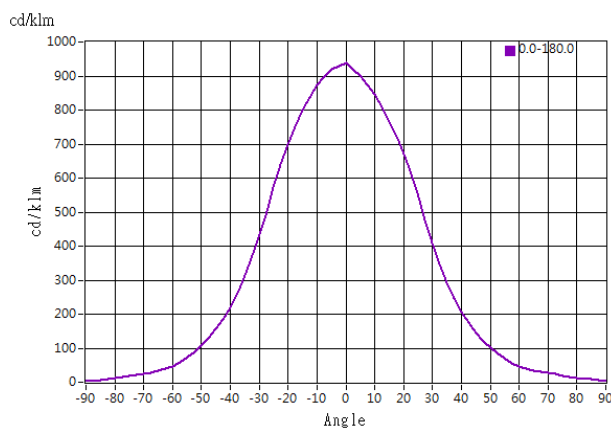

Illuminance At Distances

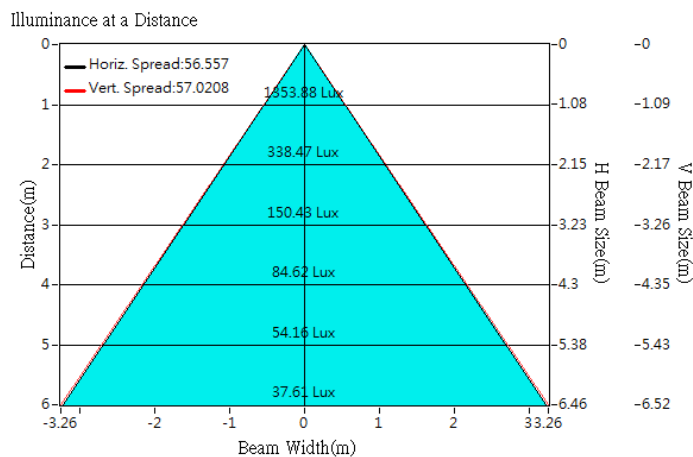



Optical Characteristics

| | | | |
|-------------------|------------------------------|-------------------|--|
| Model Number | CKO-CH15-060027-4350 | | <p>"H" definition</p> <p>LES CoB</p> |
| LED | CXB1816 | | |
| LES / LED Size | Φ 12 mm | | |
| FWHM (D50) | 55° | | |
| Field Angle (D10) | 100° | | |
| H (distance) | 3.65 mm | | |
| Dimension | Φ =60 mm, Thickness=26.85 mm | | |
| Luminous Flux | 1770 lm | Measured @ 15.6 W | |
| Material | PC / UL94V2 | | |

cd/klm

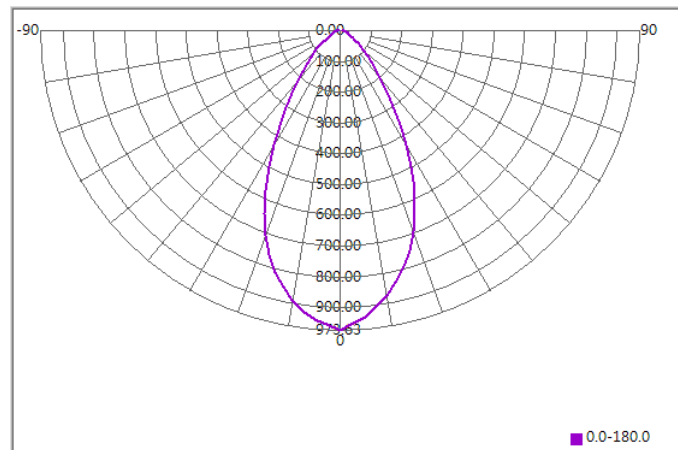

Illuminance At Distances

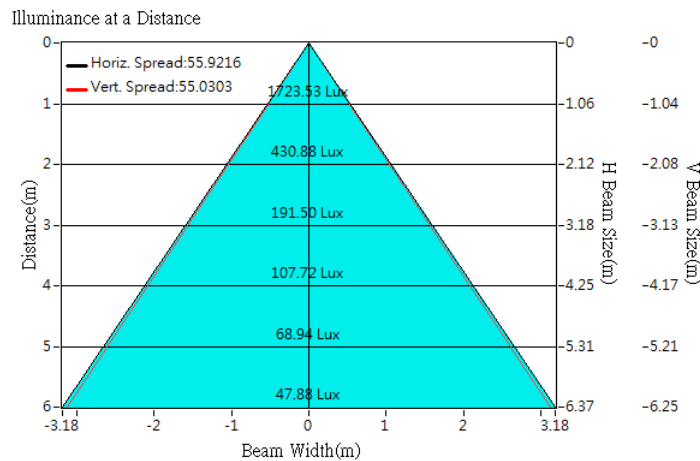



Optical Characteristics

| | | | |
|-------------------|------------------------------|-------------------|-----------------------|
| Model Number | CKO-CH15-060027-4350 | | <p>"H" definition</p> |
| LED | CXA1820 | | |
| LES / LED Size | Φ 12 mm | | |
| FWHM (D50) | 55° | | |
| Field Angle (D10) | 102° | | |
| H (distance) | 3.65 mm | | |
| Dimension | Φ =60 mm, Thickness=26.85 mm | | |
| Luminous Flux | 1837 lm | Measured @ 19.6 W | |
| Material | PC / UL94V2 | | |

cd/klm

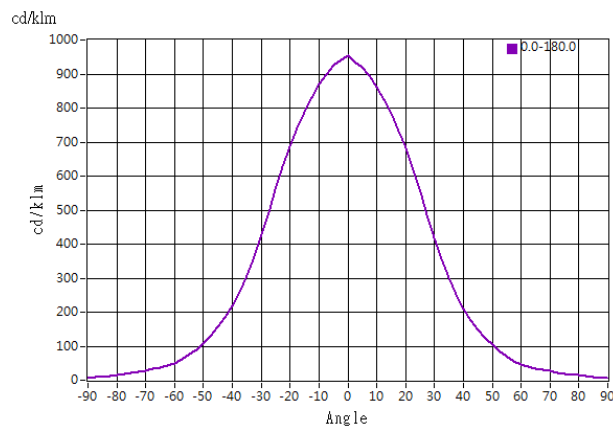

Illuminance At Distances

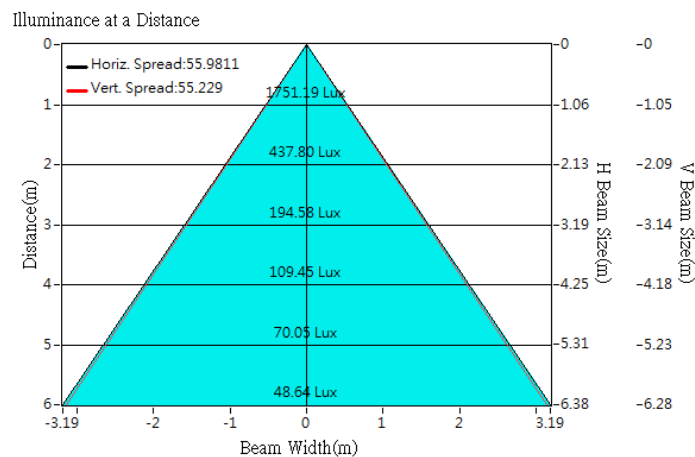



Optical Characteristics

| | | |
|-------------------|------------------------------|-----------------------|
| Model Number | CKO-CH15-060027-4350 | <p>"H" definition</p> |
| LED | CXB1820 | |
| LES / LED Size | Φ 12 mm | |
| FWHM (D50) | 56° | |
| Field Angle (D10) | 103° | |
| H (distance) | 3.65 mm | |
| Dimension | Φ =60 mm, Thickness=26.85 mm | |
| Luminous Flux | 2249 lm | |
| Material | PC / UL94V2 | |

cd/klm

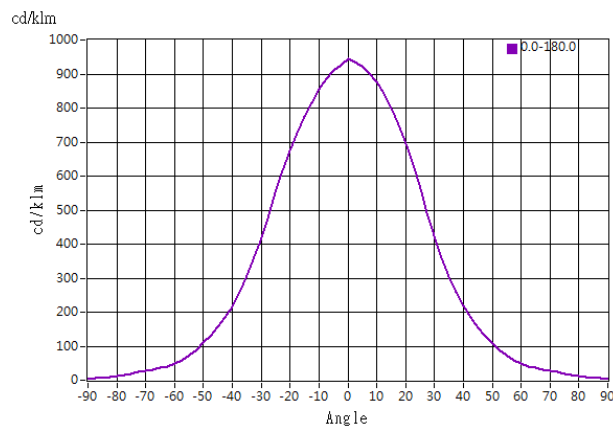

Illuminance At Distances

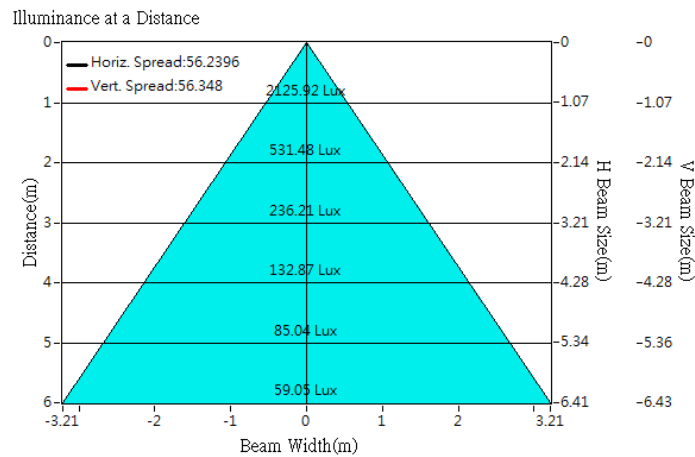



Optical Characteristics

| | | | |
|-------------------|------------------------------|-------------------|-----------------------|
| Model Number | CKO-CH15-060027-4350 | | <p>"H" definition</p> |
| LED | CXA1830 | | |
| LES / LED Size | Φ 14 mm | | |
| FWHM (D50) | 56° | | |
| Field Angle (D10) | 102° | | |
| H (distance) | 3.65 mm | | |
| Dimension | Φ =60 mm, Thickness=26.85 mm | | |
| Luminous Flux | 2408 lm | Measured @ 27.4 W | |
| Material | PC / UL94V2 | | |

cd/klm

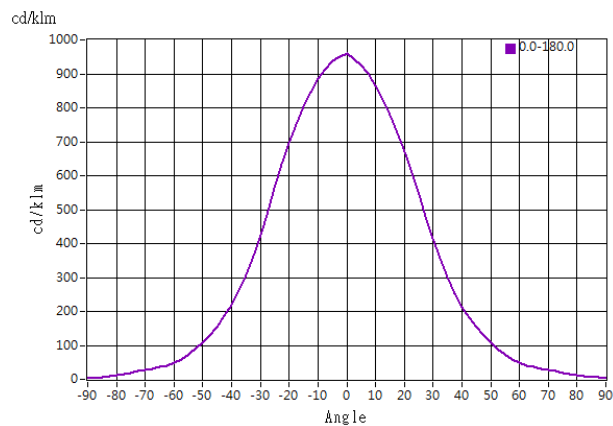

Illuminance At Distances

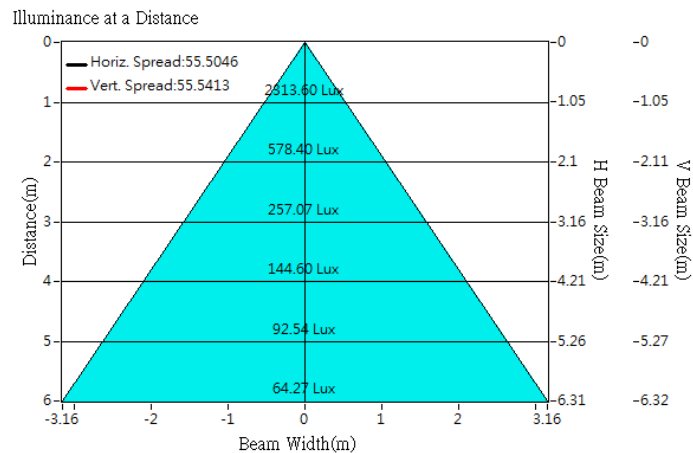



Optical Characteristics

| | | |
|-------------------|------------------------------|-----------------------|
| Model Number | CKO-CH15-060027-4350 | <p>"H" definition</p> |
| LED | CXB1830 | |
| LES / LED Size | Φ 14 mm | |
| FWHM (D50) | 56° | |
| Field Angle (D10) | 103° | |
| H (distance) | 3.65 mm | |
| Dimension | Φ =60 mm, Thickness=26.85 mm | |
| Luminous Flux | 3192 lm | |
| Material | PC / UL94V2 | |

cd/klm

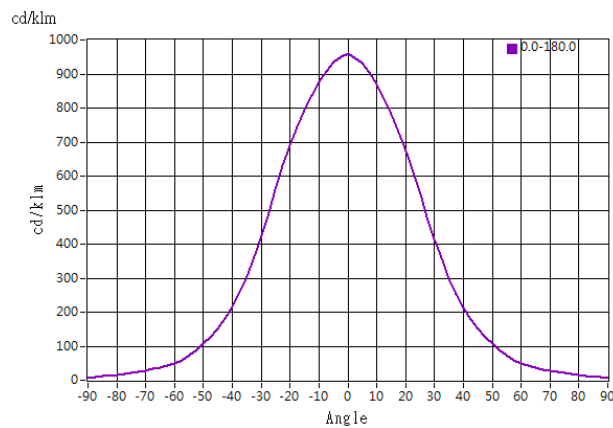

Illuminance At Distances

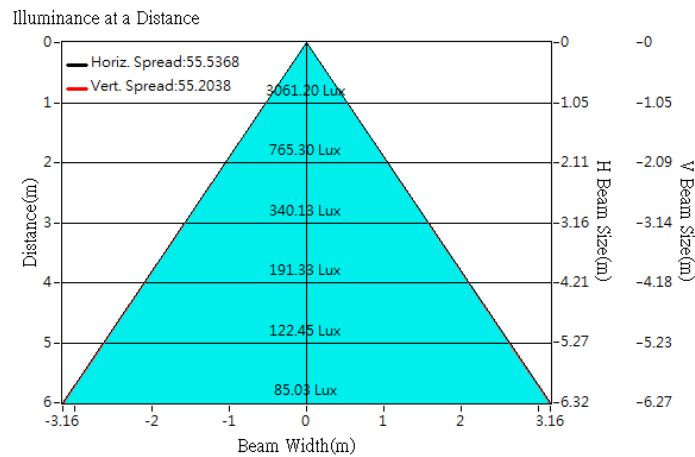



Optical Characteristics

| | | |
|-------------------|------------------------------|-----------------------|
| Model Number | CKO-CH15-060027-4350 | <p>"H" definition</p> |
| LED | CMA1840 | |
| LES / LED Size | Φ 14 mm | |
| FWHM (D50) | 57° | |
| Field Angle (D10) | 104° | |
| H (distance) | 3.65 mm | |
| Dimension | Φ =60 mm, Thickness=26.85 mm | |
| Luminous Flux | 4331 lm | |
| Material | PC / UL94V2 | |

cd/klm

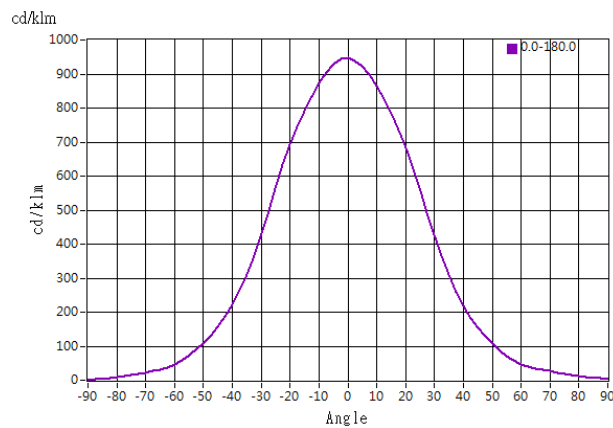

Illuminance At Distances

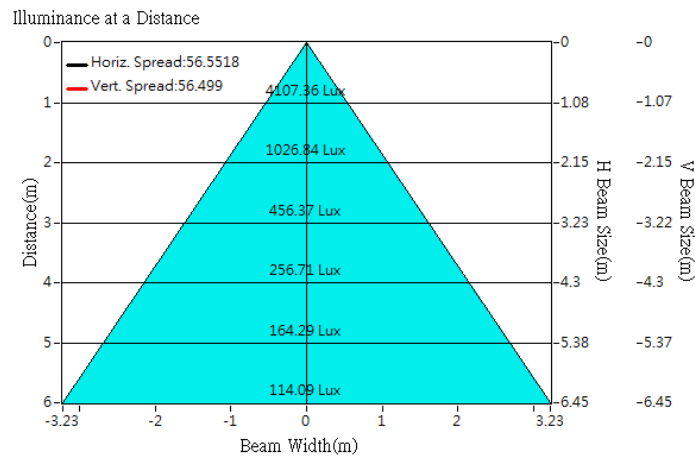



Optical Characteristics

| | | | |
|-------------------|------------------------------|-------------------|-----------------------|
| Model Number | CKO-CH15-060027-4350 | | <p>"H" definition</p> |
| LED | CMT1922 | | |
| LES / LED Size | Φ 14.5 mm | | |
| FWHM (D50) | 56° | | |
| Field Angle (D10) | 103° | | |
| H (distance) | 3.65 mm | | |
| Dimension | Φ =60 mm, Thickness=26.85 mm | | |
| Luminous Flux | 2401 lm | Measured @ 21.8 W | |
| Material | PC / UL94V2 | | |

cd/klm

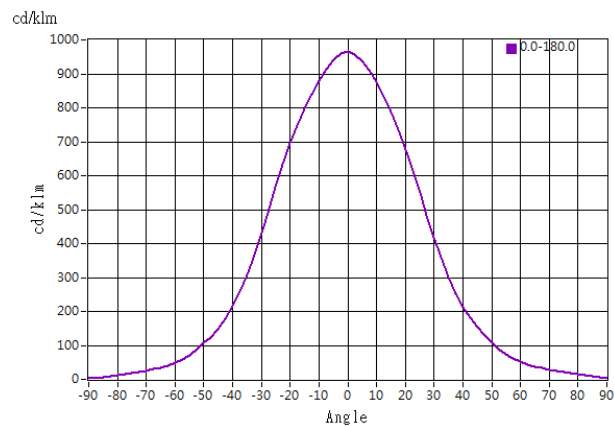

Illuminance At Distances

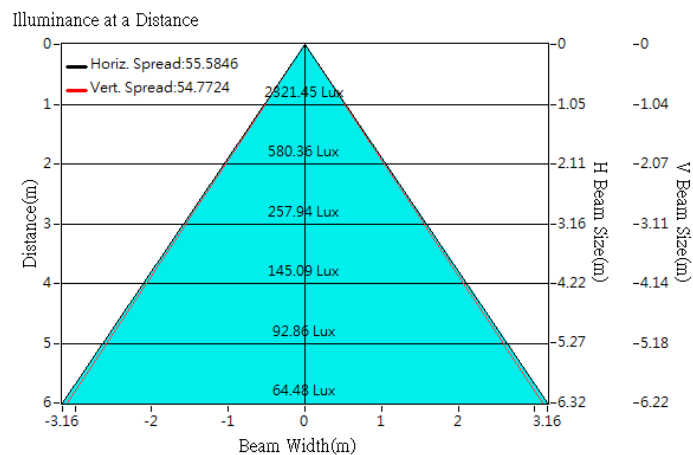



Optical Characteristics

| | | | |
|-------------------|------------------------------|-------------------|-----------------------|
| Model Number | CKO-CH15-060027-4350 | | <p>"H" definition</p> |
| LED | CMT1925 | | |
| LES / LED Size | Φ 14.5 mm | | |
| FWHM (D50) | 53° | | |
| Field Angle (D10) | 102° | | |
| H (distance) | 3.65 mm | | |
| Dimension | Φ =60 mm, Thickness=26.85 mm | | |
| Luminous Flux | 2806 lm | Measured @ 25.3 W | |
| Material | PC / UL94V2 | | |

cd/klm

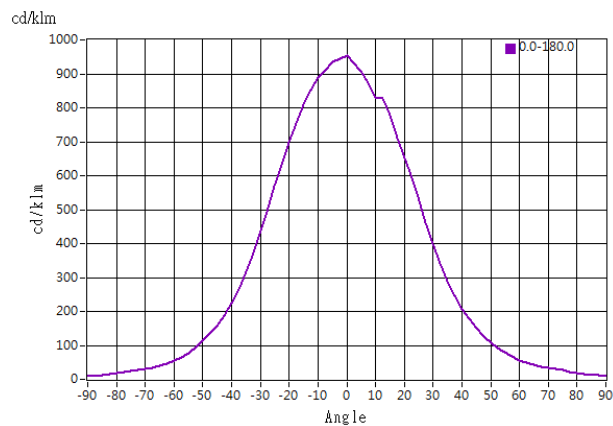

Illuminance At Distances

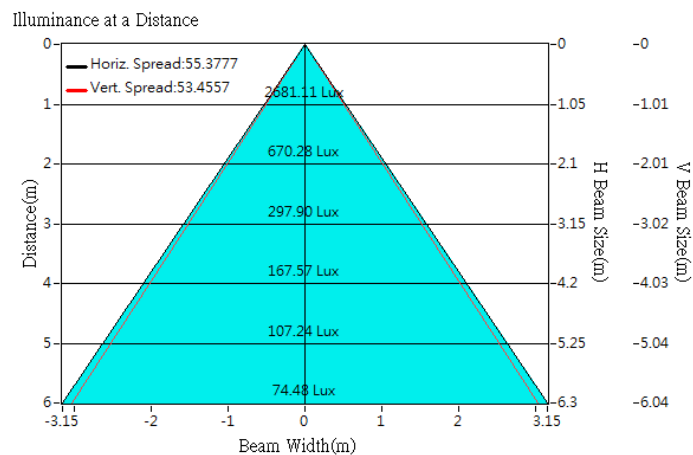



Optical Characteristics

| | | |
|-------------------|------------------------------|-----------------------|
| Model Number | CKO-CH15-060027-4350 | <p>"H" definition</p> |
| LED | CMT1930 | |
| LES / LED Size | Φ 14.5 mm | |
| FWHM (D50) | 55° | |
| Field Angle (D10) | 104° | |
| H (distance) | 3.65 mm | |
| Dimension | Φ =60 mm, Thickness=26.85 mm | |
| Luminous Flux | 3145 lm | |
| Material | PC / UL94V2 | |

cd/klm

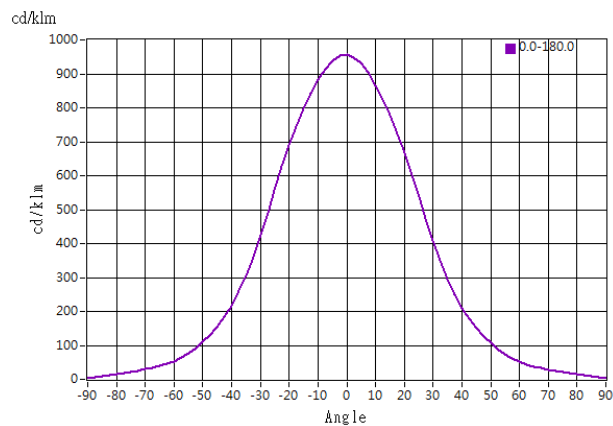

Illuminance At Distances

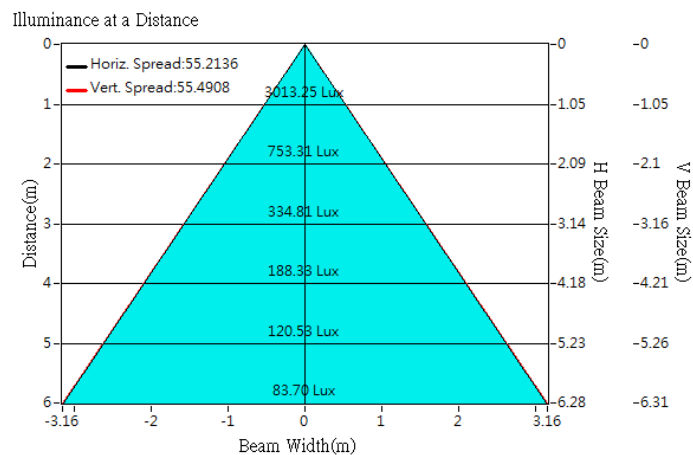

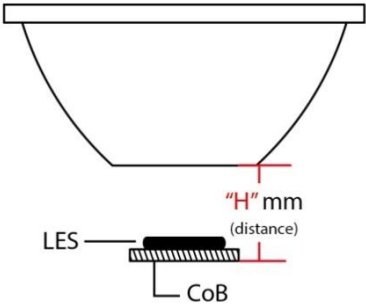

Optical Characteristics

| | | |
|-------------------|------------------------------|--|
| Model Number | CKO-CH15-060027-4350 | <p>"H" definition</p>  |
| LED | CMT1945 | |
| LES / LED Size | Φ 14.5 mm | |
| FWHM (D50) | 55° | |
| Field Angle (D10) | 103° | |
| H (distance) | 3.65 mm | |
| Dimension | Φ =60 mm, Thickness=26.85 mm | |
| Luminous Flux | 4522 lm Measured @ 43.7 W | |
| Material | PC / UL94V2 | |

cd/klm

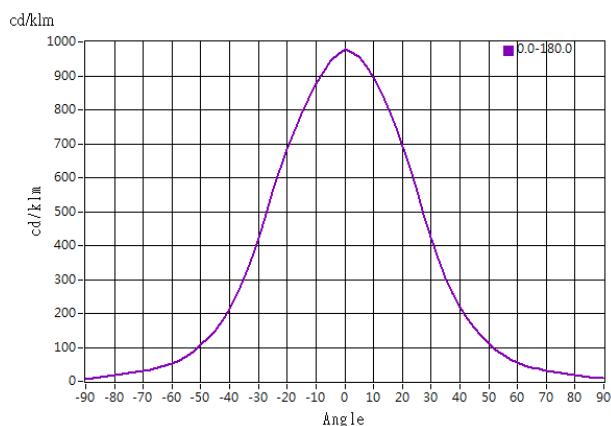

Illuminance At Distances

