



## Product Model Number

**CKO-CH15-075033-4460**

### ✓ Model Number Definitions

**CKO-XXXX-XXXXXX-XXXX**



- A. Chun Kuang Optics Corp. Product
- B. Product Type: product abbreviation  
Ex:  
CH→CoB High Intensity  
CC→CoB Compact  
CS→Soft Shading for CoB LED  
HC→Holder for CoB LED

- C. Identity Code
- D. Lens / Fixture Size  
Ex: 075026=Φ75mm / Thickness=26mm (round up)
- C. Serial Numbers

The lens datasheet is applicable for **Philips LED**, that manufactured by Chun Kuang Optics Corp.

### ✓ Dimensions (mm) : Φ75 x 33

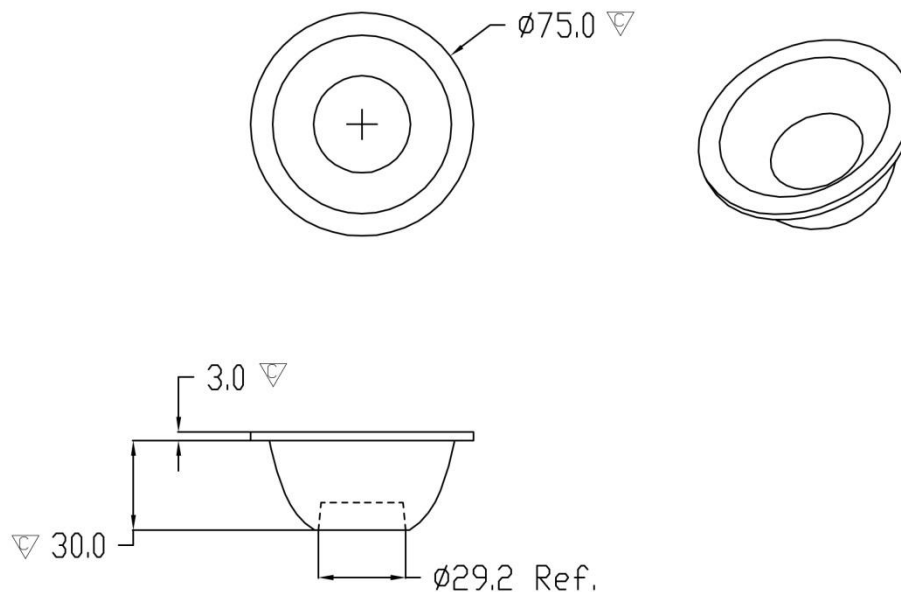

▽:Critical Dimension





## Optical Characteristics

Model Number	CKO-CH15-075033-4460		<p>"H" definition</p>
LED	Fortimo SLM 1203 L09 G6		
LES / LED Size	Φ 9 mm		
FWHM (D50)	56°		
Field Angle (D10)	91°		
H (distance)	3.65mm		
Dimension	Φ =75 mm, Thickness=33 mm		
Luminous Flux	1157 lm	Measured @ 10.5W	
Material	PC / UL94V2		

## cd/klm

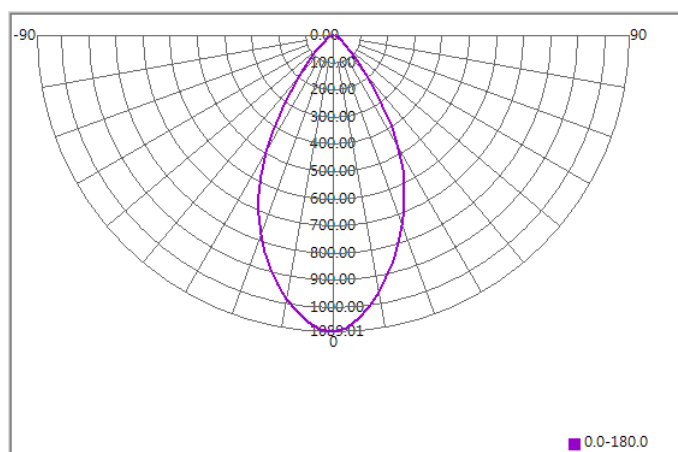

## Illuminance At Distances

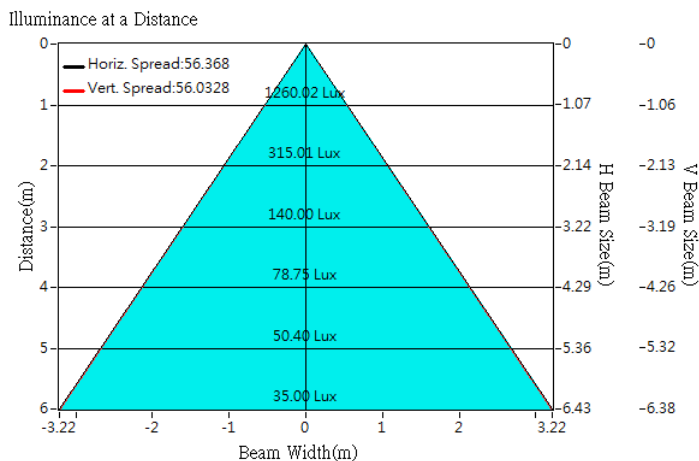



## Optical Characteristics

Model Number	CKO-CH15-075033-4460		<p>"H" definition</p>
LED	Fortimo SLM PW 1204 L09 G7		
LES / LED Size	Φ 9 mm		
FWHM (D50)	56°		
Field Angle (D10)	90°		
H (distance)	3.65mm		
Dimension	Φ =75 mm, Thickness=33 mm		
Luminous Flux	2140 lm	Measured @ 26.8 W	
Material	PC / UL94V2		

## cd/klm

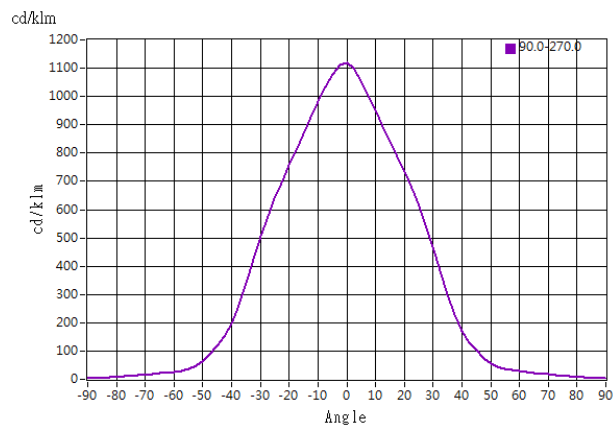

## Illuminance At Distances

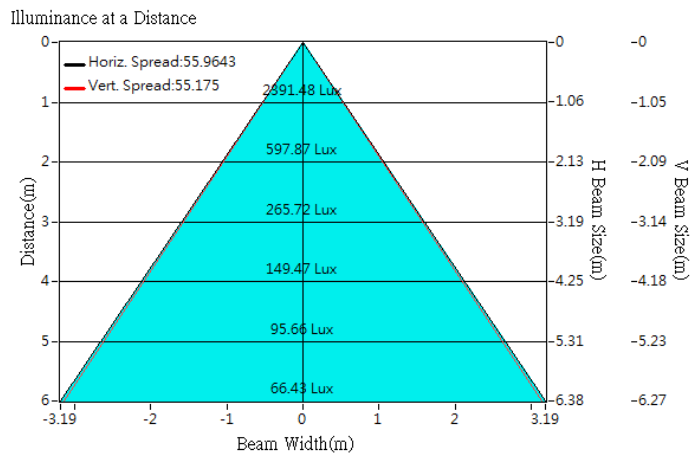

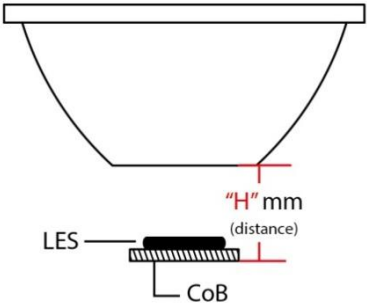

## Optical Characteristics

Model Number	CKO-CH15-075033-4460		<p>"H" definition</p> 
LED	Fortimo SLM 1201 L09 G7N		
LES / LED Size	Φ 9.8 mm		
FWHM (D50)	55°		
Field Angle (D10)	91°		
H (distance)	3.65mm		
Dimension	Φ =75 mm, Thickness=33 mm		
Luminous Flux	437 lm	Measured @3.1W	
Material	PC / UL94V2		

## cd/klm

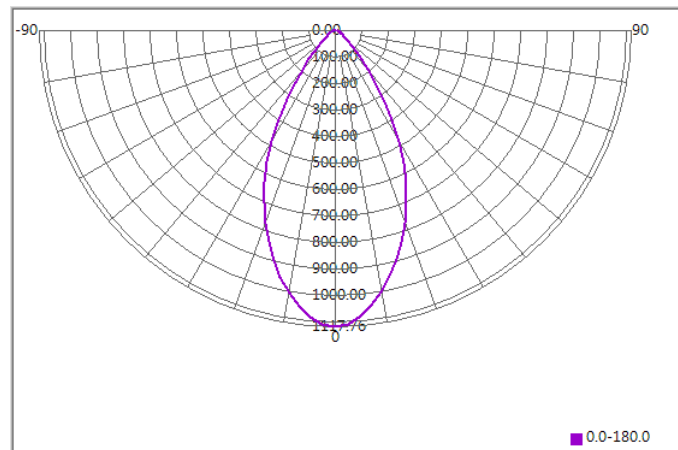

## Illuminance At Distances

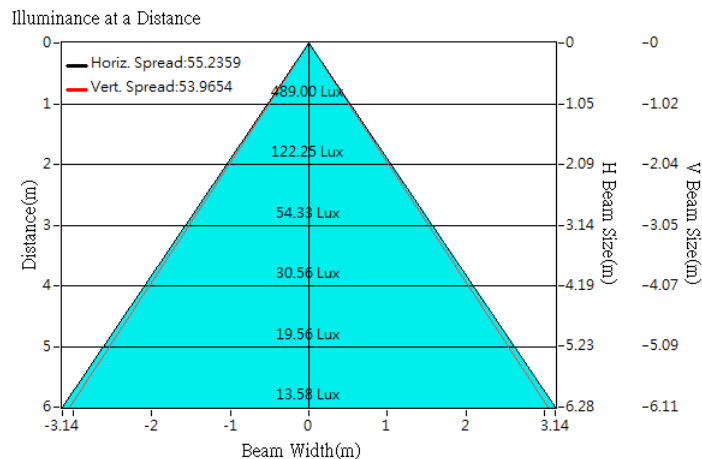



## Optical Characteristics

Model Number	CKO-CH15-075033-4460		<p>"H" definition</p> <p>LES</p> <p>CoB</p>
LED	Fortimo SLM 1202 L09 G7N		
LES / LED Size	Φ 9.8 mm		
FWHM (D50)	54°		
Field Angle (D10)	90°		
H (distance)	3.65mm		
Dimension	Φ =75 mm, Thickness=33 mm		
Luminous Flux	850 lm	Measured @6.1 W	
Material	PC / UL94V2		

## cd/klm

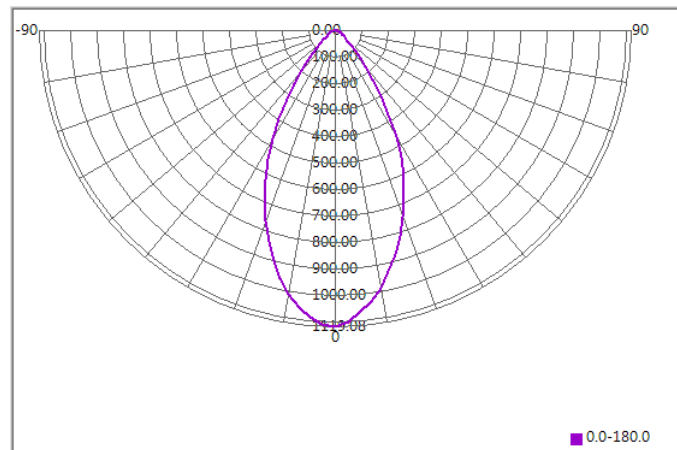

## Illuminance At Distances

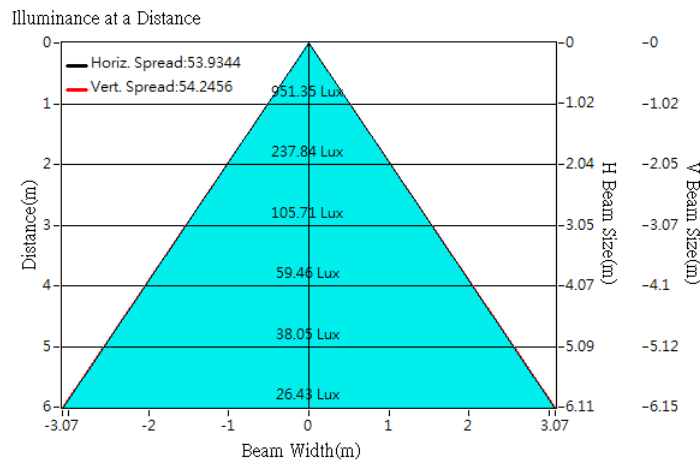



## Optical Characteristics

Model Number	CKO-CH15-075033-4460		<p>"H" definition</p> <p>LES CoB</p>
LED	Fortimo SLM 1203 L09 G7N		
LES / LED Size	Φ 9.8 mm		
FWHM (D50)	55°		
Field Angle (D10)	90°		
H (distance)	3.65mm		
Dimension	Φ =75 mm, Thickness=33 mm		
Luminous Flux	1245 lm	Measured @9.2 W	
Material	PC / UL94V2		

## cd/klm

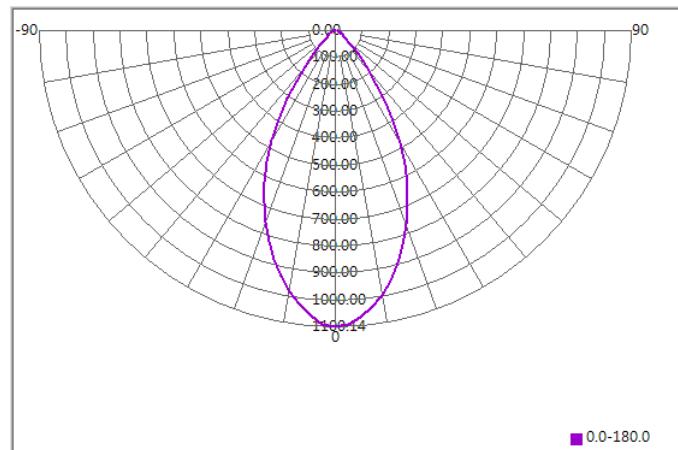

## Illuminance At Distances

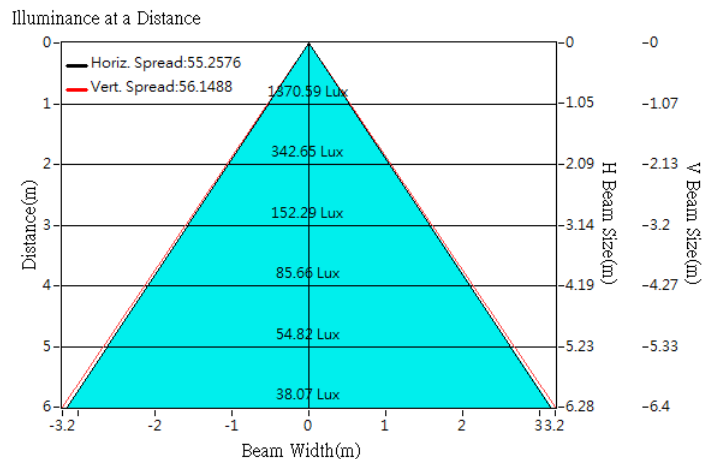



## Optical Characteristics

Model Number	CKO-CH15-075033-4460	<p>"H" definition</p> <p>LES</p> <p>CoB</p> <p>"H" mm (distance)</p>
LED	<b>Fortimo SLM 1204 L09 G7N</b>	
LES / LED Size	Φ 9.8 mm	
FWHM (D50)	54°	
Field Angle (D10)	89°	
H (distance)	3.65mm	
Dimension	Φ =75 mm, Thickness=33 mm	
Luminous Flux	1647 lm	
Material	PC / UL94V2	

## cd/klm

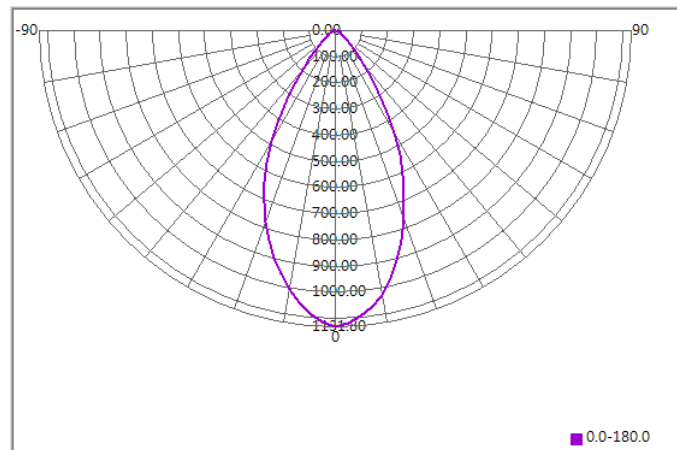

## Illuminance At Distances

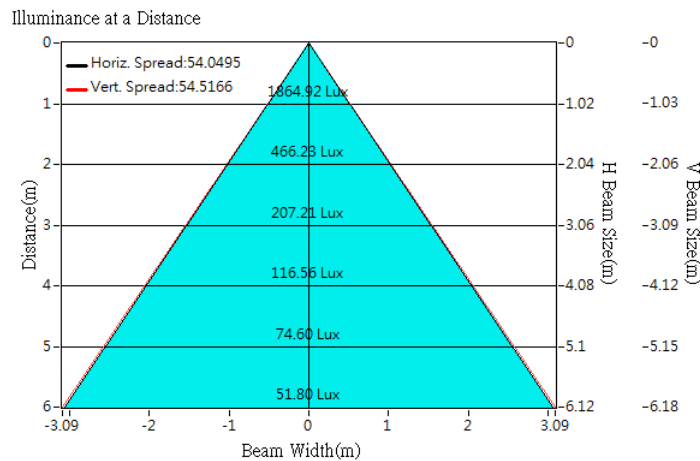



## Optical Characteristics

Model Number	CKO-CH15-075033-4460		<p>"H" definition</p>
LED	Fortimo SLM 830 1205 L13 G7		
LES / LED Size	Φ 13 mm		
FWHM (D50)	57°		
Field Angle (D10)	93°		
H (distance)	3.65mm		
Dimension	Φ =75 mm, Thickness=33 mm		
Luminous Flux	1795 lm	Measured @ 17.6 W	
Material	PC / UL94V2		

## cd/klm

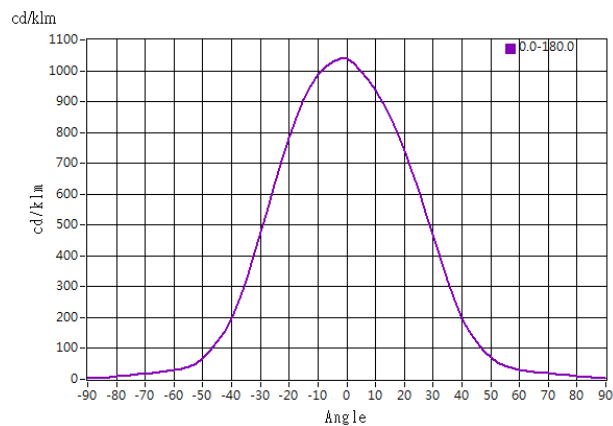

## Illuminance At Distances

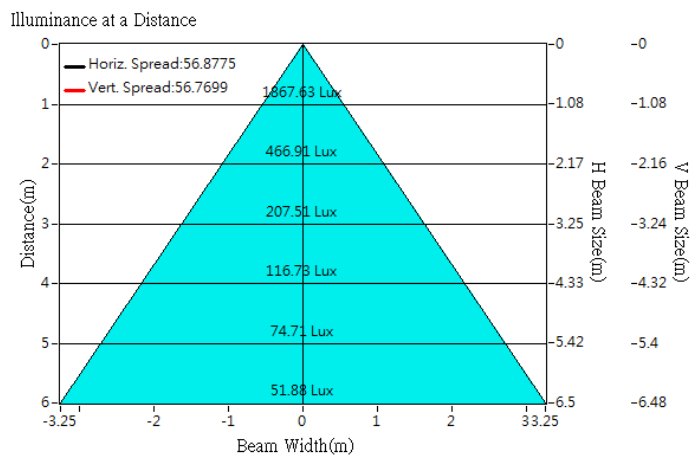



## Optical Characteristics

Model Number	CKO-CH15-075033-4460	<p>"H" definition</p>
LED	<b>Fortimo SLM PW 1205 L13 G6</b>	
LES / LED Size	Φ 13 mm	
FWHM (D50)	60°	
Field Angle (D10)	89°	
H (distance)	3.65mm	
Dimension	Φ =75 mm, Thickness=33 mm	
Luminous Flux	2245 lm	
Material	PC / UL94V2	

## cd/klm

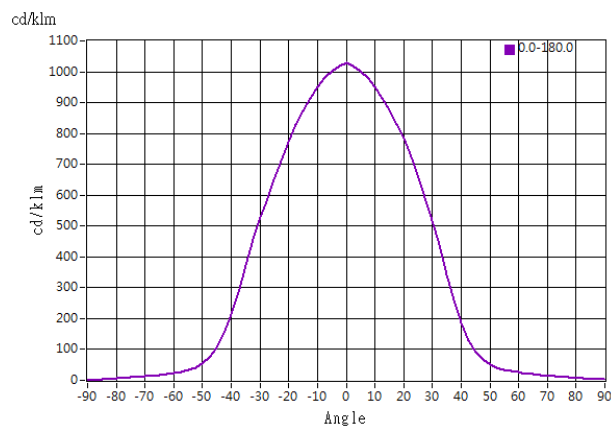

## Illuminance At Distances

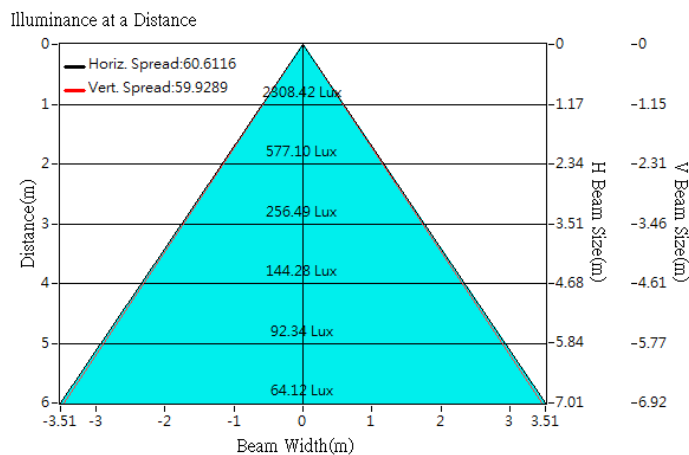



## Optical Characteristics

Model Number	CKO-CH15-075033-4460		<p>"H" definition</p> <p>LES</p> <p>CoB</p>
LED	Fortimo SLM 1205 L15 G7N		
LES / LED Size	Φ 14.5 mm		
FWHM (D50)	56°		
Field Angle (D10)	92°		
H (distance)	3.65mm		
Dimension	Φ =75 mm, Thickness=33 mm		
Luminous Flux	2042 lm	Measured @15.4 W	
Material	PC / UL94V2		

## cd/klm

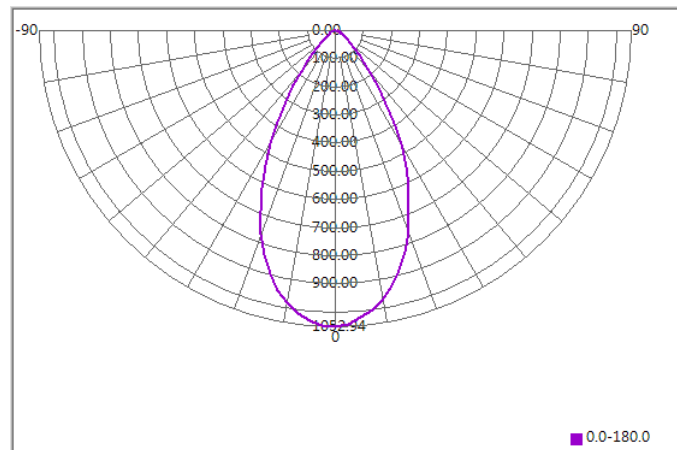

## Illuminance At Distances

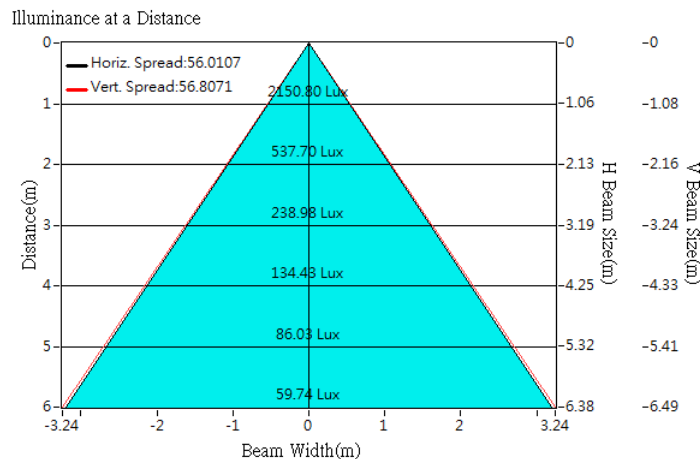



## Optical Characteristics

Model Number	CKO-CH15-075033-4460		<p>"H" definition</p>
LED	Fortimo SLM 1206 L15 G7N		
LES / LED Size	Φ 14.5 mm		
FWHM (D50)	56°		
Field Angle (D10)	93°		
H (distance)	3.65mm		
Dimension	Φ =75 mm, Thickness=33 mm		
Luminous Flux	2522 lm	Measured @18.5 W	
Material	PC / UL94V2		

## cd/klm

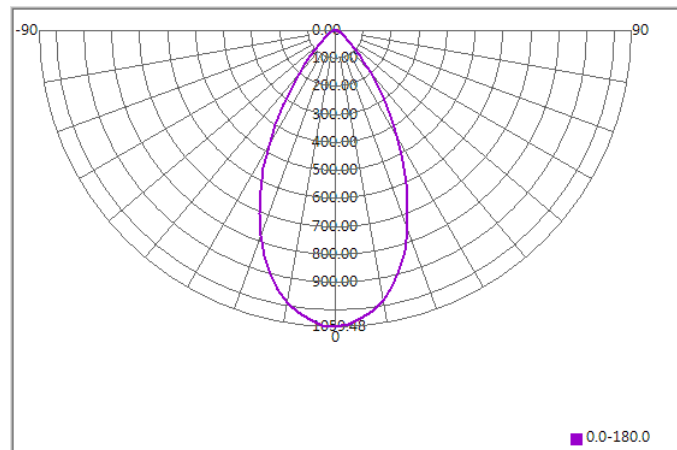

## Illuminance At Distances

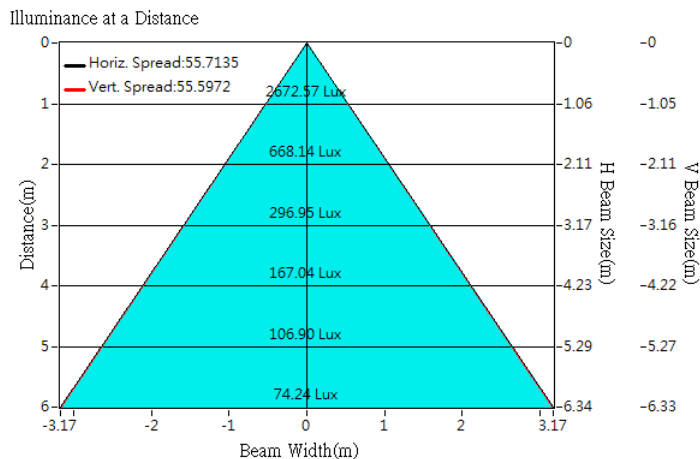



## Optical Characteristics

Model Number	CKO-CH15-075033-4460		<p>"H" definition</p> <p>LES</p> <p>CoB</p>
LED	Fortimo SLM 1208 L15 G7N		
LES / LED Size	Φ 14.5 mm		
FWHM (D50)	57°		
Field Angle (D10)	92°		
H (distance)	3.65mm		
Dimension	Φ =75 mm, Thickness=33 mm		
Luminous Flux	3543 lm	Measured @24.7 W	
Material	PC / UL94V2		

## cd/klm

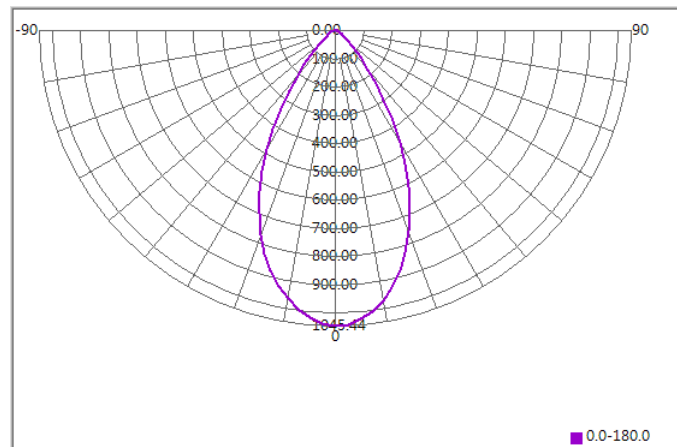

## Illuminance At Distances

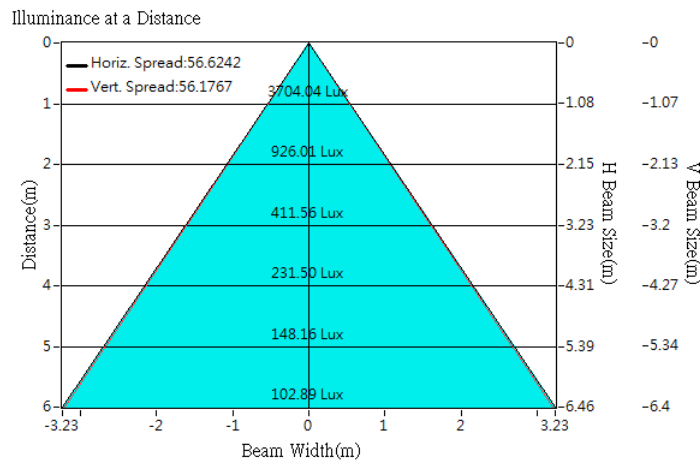



## Optical Characteristics

Model Number	CKO-CH15-075033-4460		<p>"H" definition</p> <p>LES</p> <p>CoB</p>
LED	Fortimo SLM 1210 L15 G7N		
LES / LED Size	Φ 14.5 mm		
FWHM (D50)	57°		
Field Angle (D10)	95°		
H (distance)	3.65mm		
Dimension	Φ =75 mm, Thickness=33 mm		
Luminous Flux	3721 lm	Measured @30.9 W	
Material	PC / UL94V2		

## cd/klm

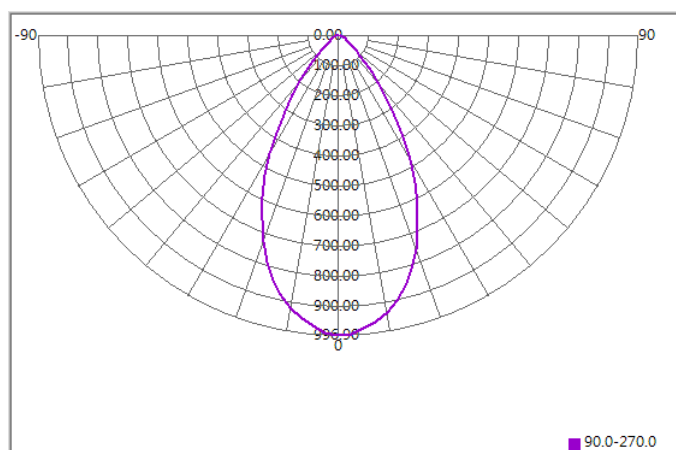

## Illuminance At Distances

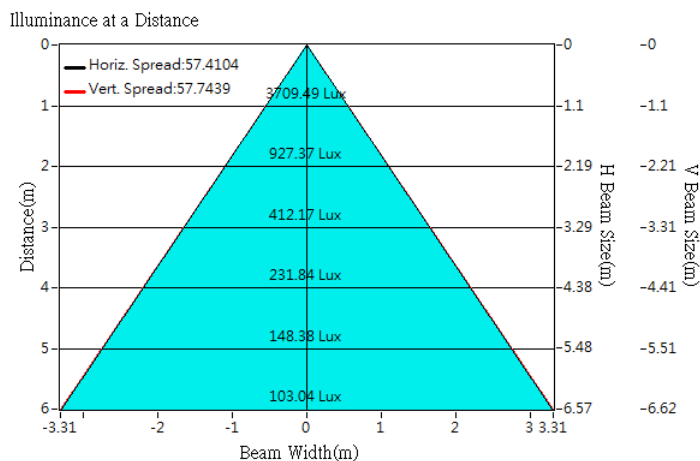



## Optical Characteristics

Model Number	CKO-CH15-075033-4460		<p>"H" definition</p>
LED	Fortimo SLM 1208 L15 G7		
LES / LED Size	Φ 15 mm		
FWHM (D50)	56°		
Field Angle (D10)	93°		
H (distance)	3.65mm		
Dimension	Φ =75 mm, Thickness=33 mm		
Luminous Flux	2794 lm	Measured @ 26.3 W	
Material	PC / UL94V2		

## cd/klm

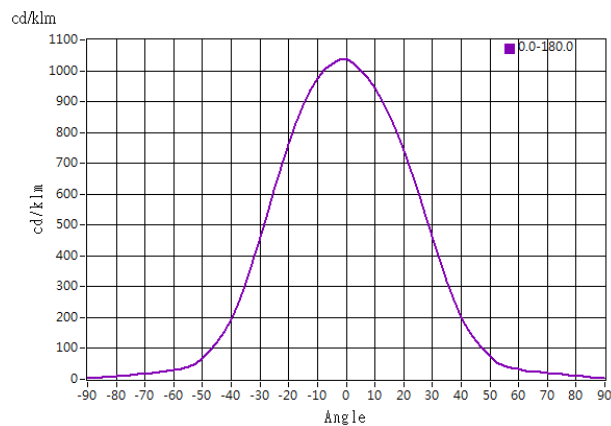

## Illuminance At Distances

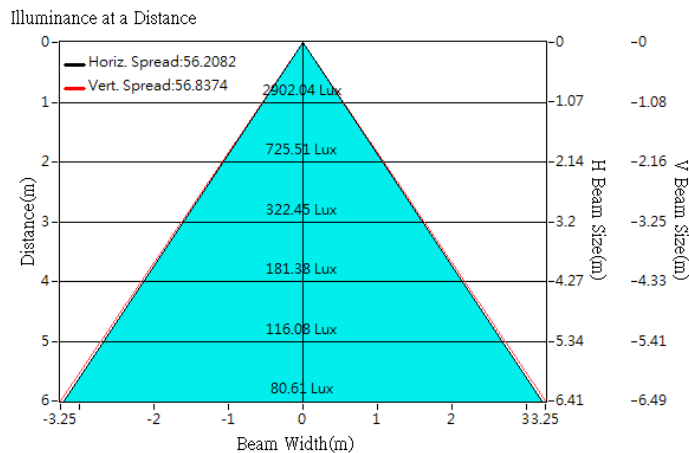



## Optical Characteristics

Model Number	CKO-CH15-075033-4460		<p>"H" definition</p>
LED	Fortimo SLM 1208 L15 G6		
LES / LED Size	Φ 15 mm		
FWHM (D50)	58°		
Field Angle (D10)	94°		
H (distance)	3.65mm		
Dimension	Φ =75 mm, Thickness=33 mm		
Luminous Flux	2348 lm	Measured @ 26.5 W	
Material	PC / UL94V2		

## cd/klm

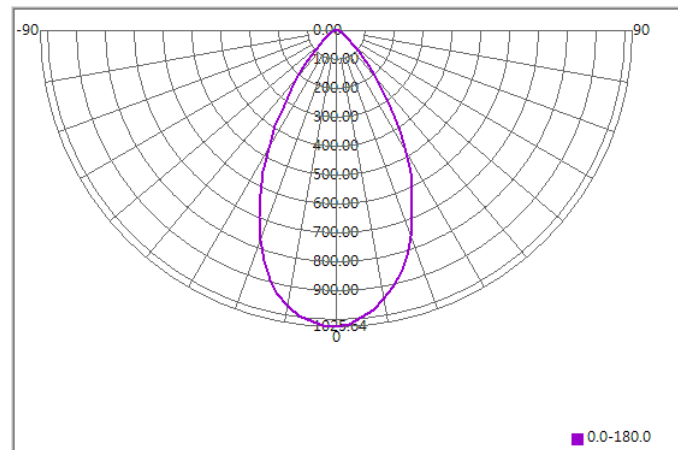

## Illuminance At Distances

