



Product Model Number

CKO-CH15-085040-5005

✓ Model Number Definitions

CKO-XXXX-XXXXXX-XXXX



- A. Chun Kuang Optics Corp. Product
- B. Product Type: product abbreviation
Ex:
CH→CoB High Intensity
CC→CoB Compact
CS→Soft Shading for CoB LED
HC→Holder for CoB LED

- C. Identity Code
- D. Lens / Fixture Size
Ex: 075026=Φ75mm / Thickness=26mm (round up)
- C. Serial Numbers

The lens datasheet is applicable for **CREE LED**, that manufactured by Chun Kuang Optics Corp.

✓ Dimensions (mm) : Φ85 x 39.7

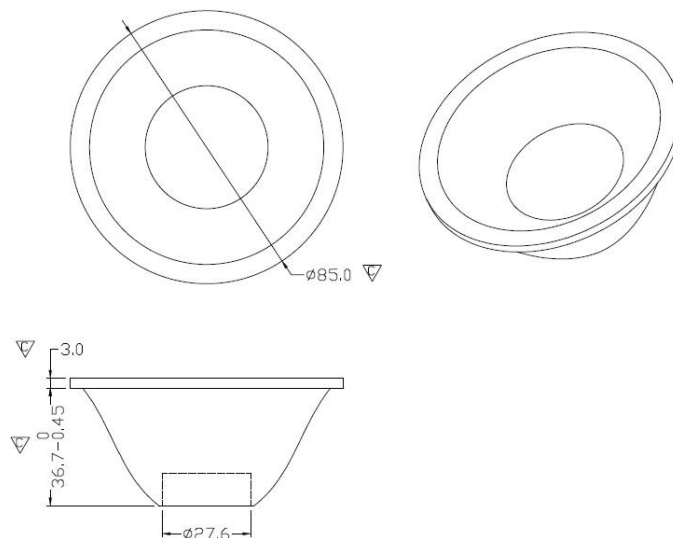

▽:Critical Dimension



Optical Characteristics

Model Number	CKO-CH15-085040-5005		<p>"H" definition</p> <p>LES CoB</p>
LED	CMT1412		
LES / LED Size	Φ 9.8 mm		
FWHM (D50)	31°		
Field Angle (D10)	61°		
H (distance)	3.65 mm		
Dimension	Φ =85 mm, Thickness=39.7 mm		
Luminous Flux	1427 lm	Measured @ 12.2 W	
Material	PC / UL94V2		

cd/klm

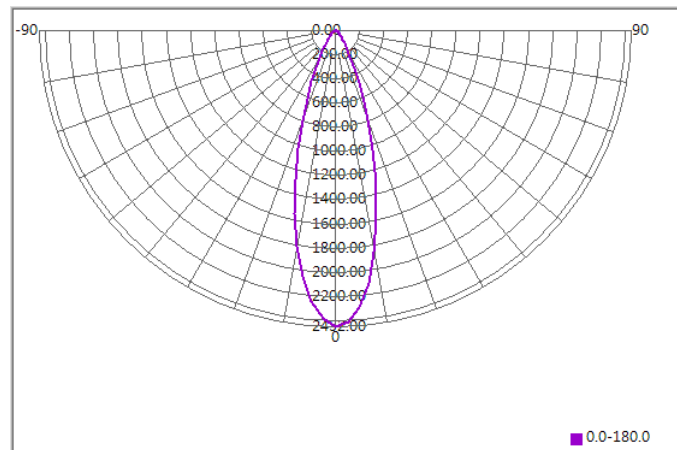

Illuminance At Distances

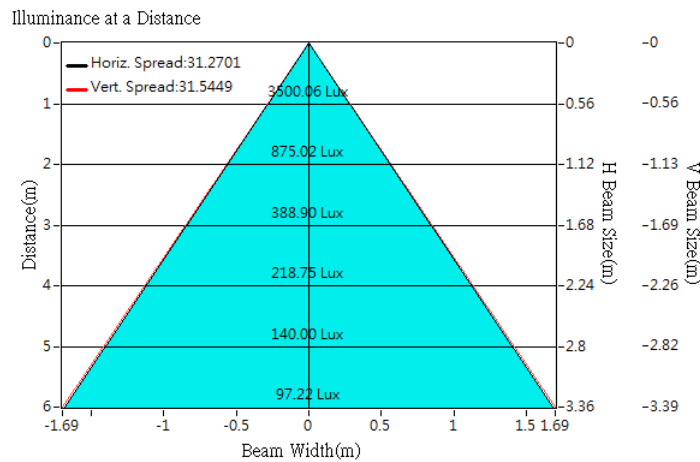



Optical Characteristics

Model Number	CKO-CH15-085040-5005		<p>"H" definition</p> <p>LES CoB</p>
LED	CXA1816		
LES / LED Size	Φ 12 mm		
FWHM (D50)	33°		
Field Angle (D10)	64°		
H (distance)	3.65 mm		
Dimension	Φ =85 mm, Thickness=39.7 mm		
Luminous Flux	1486 lm	Measured @ 16.6 W	
Material	PC / UL94V2		

cd/klm

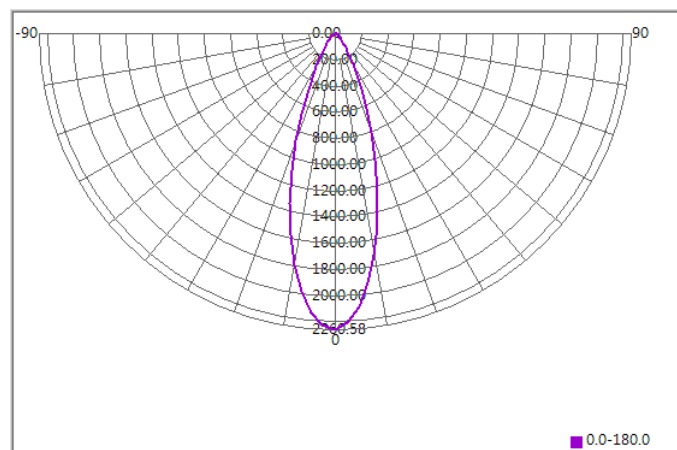

Illuminance At Distances

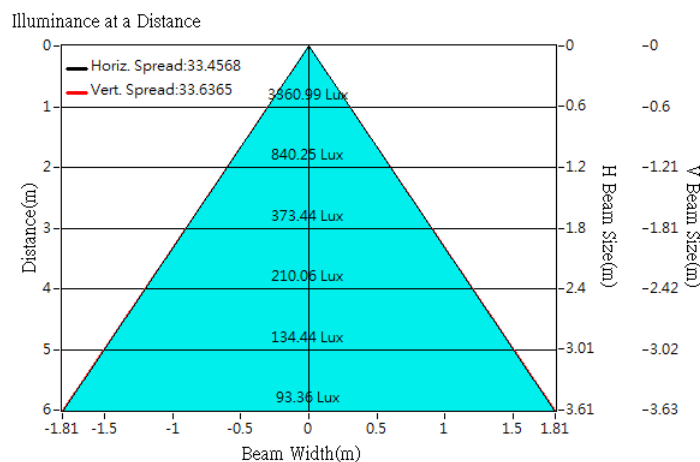



Optical Characteristics

Model Number	CKO-CH15-085040-5005	<p>"H" definition</p> <p>LES CoB</p>
LED	CXB1816	
LES / LED Size	Φ 12 mm	
FWHM (D50)	34°	
Field Angle (D10)	64°	
H (distance)	3.65 mm	
Dimension	Φ =85 mm, Thickness=39.7 mm	
Luminous Flux	1738 lm	
Material	PC / UL94V2	

cd/klm

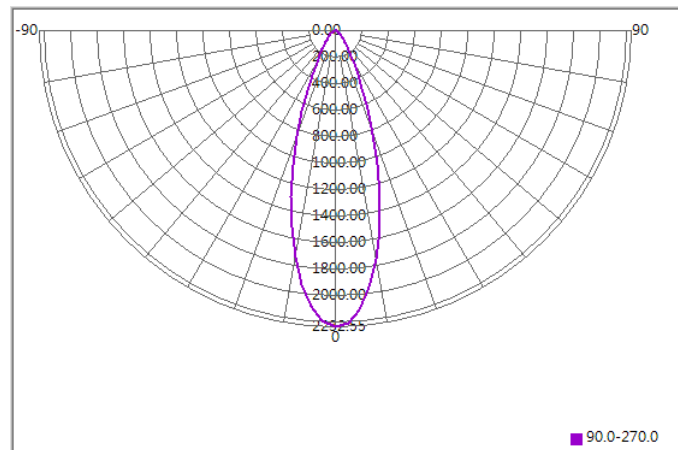

Illuminance At Distances

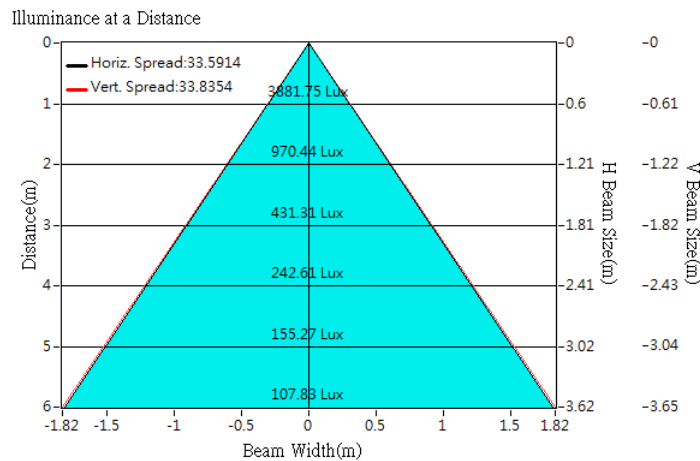



Optical Characteristics

Model Number	CKO-CH15-085040-5005	<p>"H" definition</p>
LED	CXA1820	
LES / LED Size	Φ 12 mm	
FWHM (D50)	34°	
Field Angle (D10)	65°	
H (distance)	3.65 mm	
Dimension	Φ =85 mm, Thickness=39.7 mm	
Luminous Flux	1774 lm	
Material	PC / UL94V2	

cd/klm

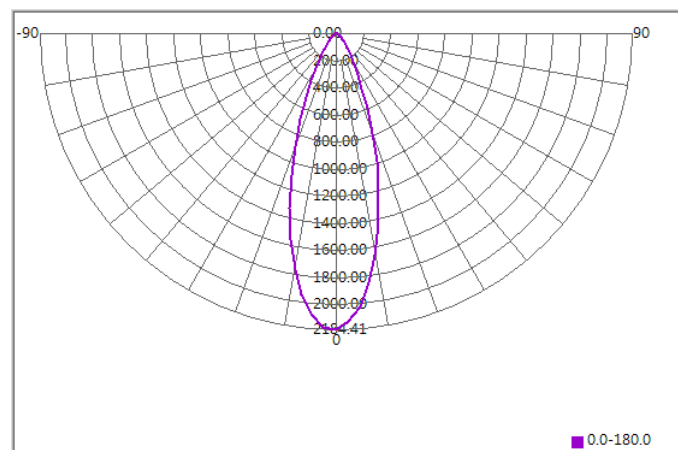

Illuminance At Distances

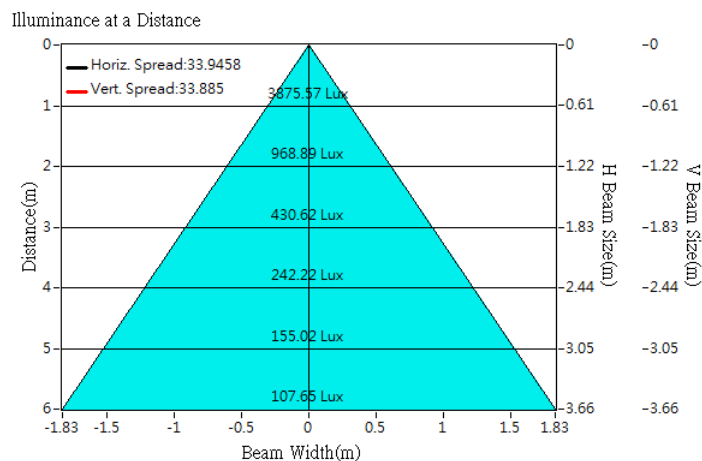



Optical Characteristics

Model Number	CKO-CH15-085040-5005	<p>"H" definition</p> <p>LES CoB</p>	
LED	CREE CXB1820		
LES / LED Size	Φ 12 mm		
FWHM (D50)	34°		
Field Angle (D10)	64°		
H (distance)	3.65 mm		
Dimension	Φ =85 mm, Thickness=39.7 mm		
Luminous Flux	2222 lm		Measured @ 19.4 W
Material	PC / UL94V2		

cd/klm

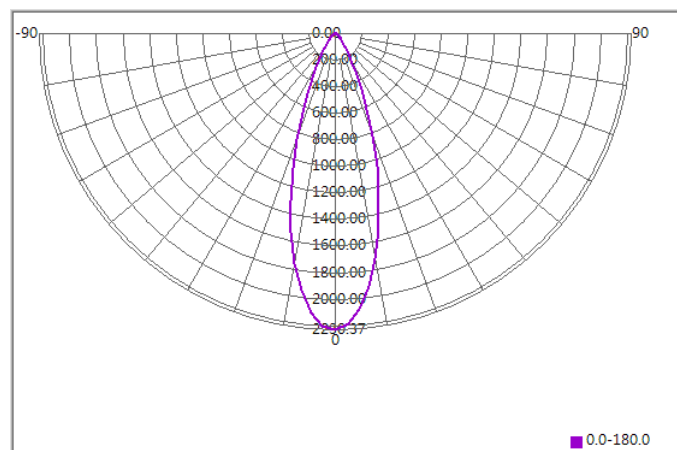

Illuminance At Distances

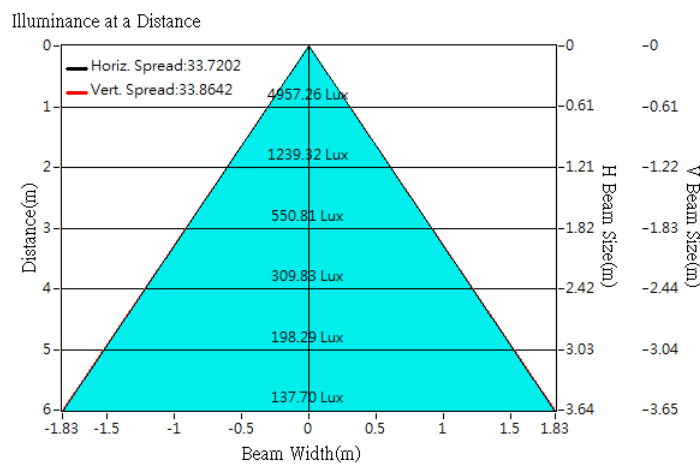



Optical Characteristics

Model Number	CKO-CH15-085040-5005		<p>"H" definition</p> <p>LES</p> <p>CoB</p>
LED	CMA1825		
LES / LED Size	Φ 12 mm		
FWHM (D50)	33°		
Field Angle (D10)	64°		
H (distance)	3.65 mm		
Dimension	Φ =85 mm, Thickness=39.7 mm		
Luminous Flux	2801 lm	Measured @ 24.5 W	
Material	PC / UL94V2		

cd/klm

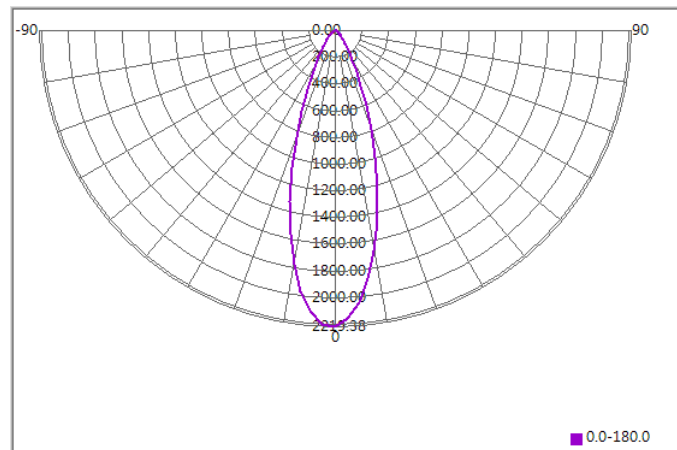

Illuminance At Distances

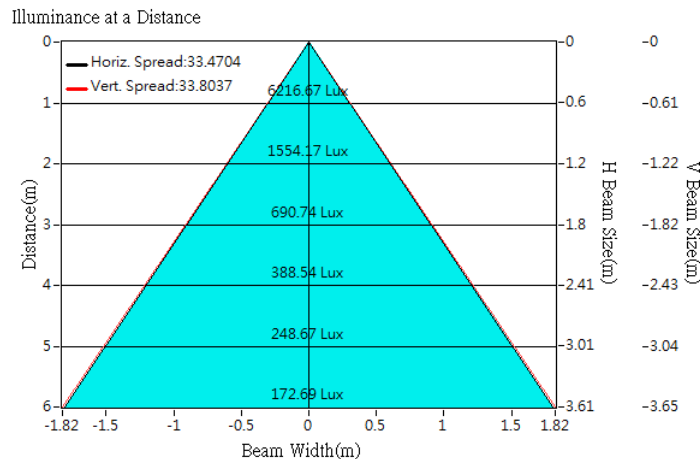

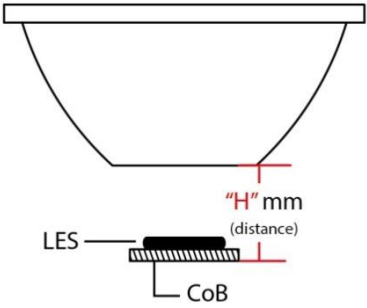

Optical Characteristics

Model Number	CKO-CH15-085040-5005		<p>"H" definition</p> 
LED	CXA1830		
LES / LED Size	Φ 14 mm		
FWHM (D50)	35°		
Field Angle (D10)	66°		
H (distance)	3.65 mm		
Dimension	Φ =85 mm, Thickness=39.7 mm		
Luminous Flux	2435 lm	Measured @ 29.9 W	
Material	PC / UL94V2		

cd/klm

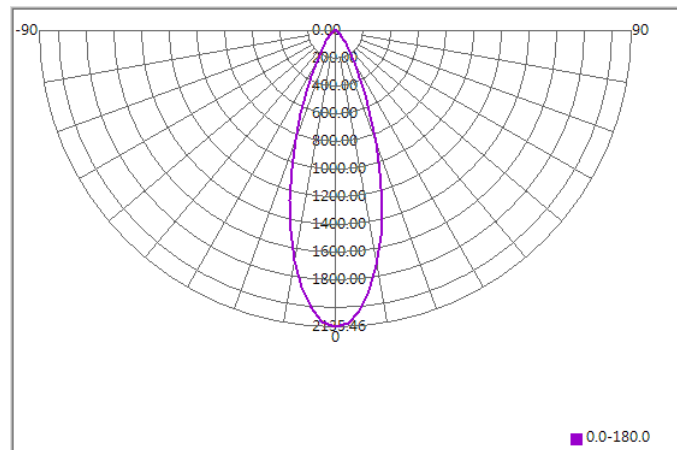

Illuminance At Distances

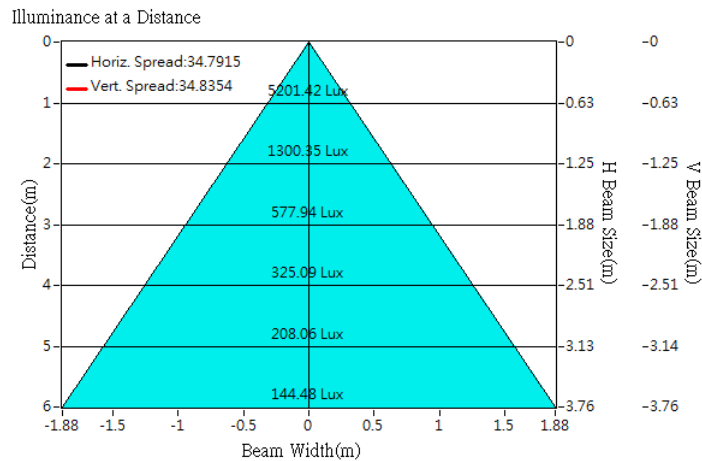



Optical Characteristics

Model Number	CKO-CH15-085040-5005		<p>"H" definition</p> <p>LES CoB</p>
LED	CREE CXB1830		
LES / LED Size	Φ 14 mm		
FWHM (D50)	35°		
Field Angle (D10)	66°		
H (distance)	3.65 mm		
Dimension	Φ =85 mm, Thickness=39.7 mm		
Luminous Flux	2540 lm	Measured @ 27.7 W	
Material	PC / UL94V2		

cd/klm

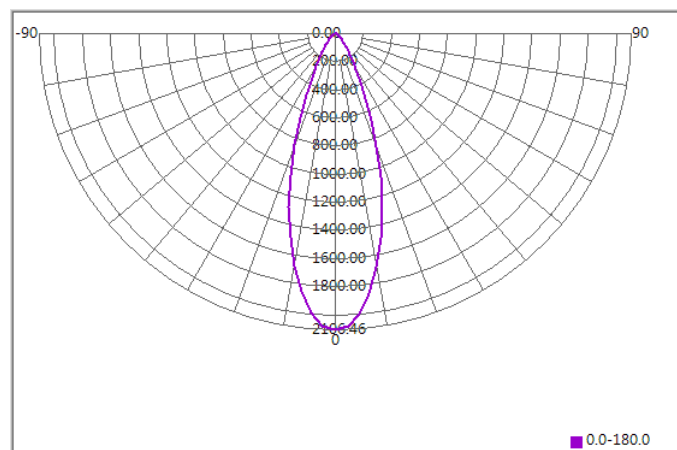

Illuminance At Distances

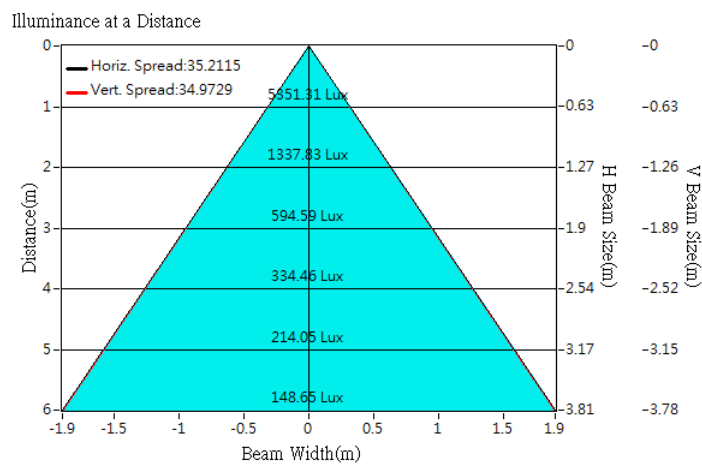



Optical Characteristics

Model Number	CKO-CH15-085040-5005		<p>"H" definition</p> <p>LES CoB</p>
LED	CMA1840		
LES / LED Size	Φ 14 mm		
FWHM (D50)	35°		
Field Angle (D10)	66°		
H (distance)	3.65 mm		
Dimension	Φ =85 mm, Thickness=39.7 mm		
Luminous Flux	4247 lm	Measured @ 38.7 W	
Material	PC / UL94V2		

cd/klm

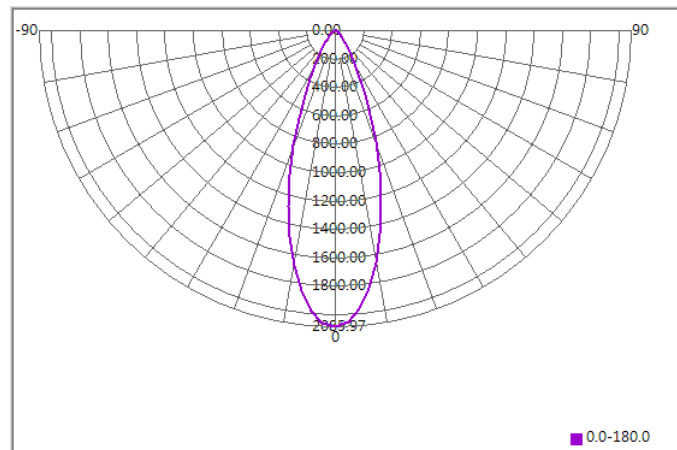

Illuminance At Distances

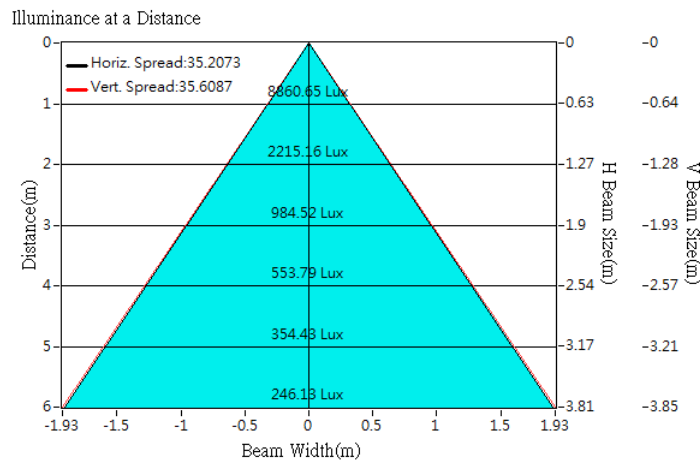



Optical Characteristics

Model Number	CKO-CH15-085040-5005		<p>"H" definition</p> <p>LES CoB</p>
LED	CMT1922		
LES / LED Size	Φ 14.5 mm		
FWHM (D50)	35°		
Field Angle (D10)	66°		
H (distance)	3.65 mm		
Dimension	Φ =85 mm, Thickness=39.7 mm		
Luminous Flux	2524 lm	Measured @ 21 W	
Material	PC / UL94V2		

cd/klm

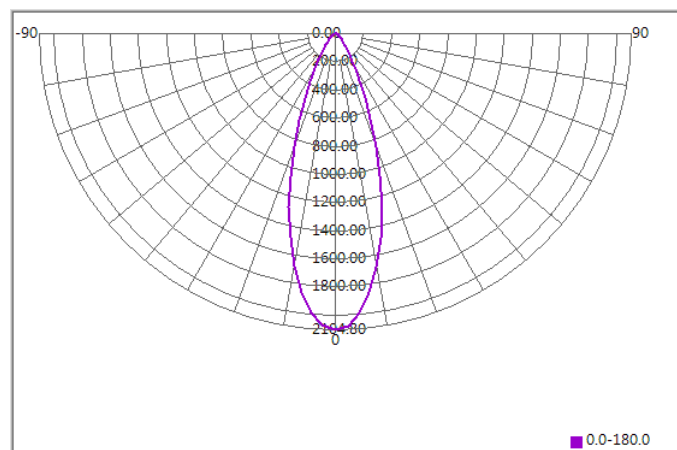

Illuminance At Distances

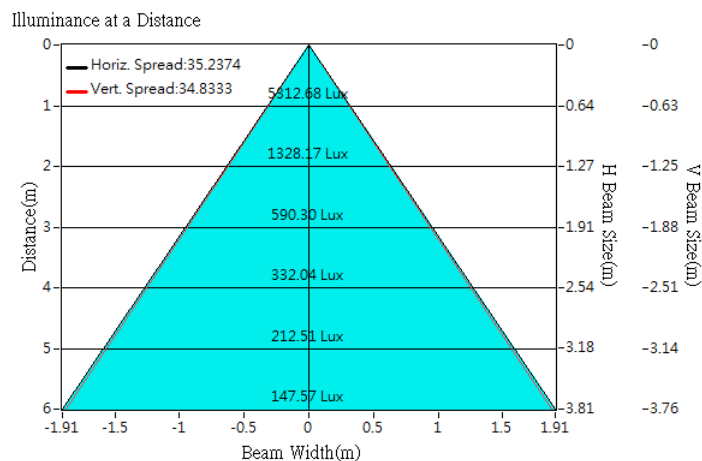



Optical Characteristics

Model Number	CKO-CH15-085040-5005		<p>"H" definition</p>
LED	CMT1925		
LES / LED Size	Φ 14.5 mm		
FWHM (D50)	36°		
Field Angle (D10)	67°		
H (distance)	3.65 mm		
Dimension	Φ =85 mm, Thickness=39.7 mm		
Luminous Flux	2867 lm	Measured @ 24.3 W	
Material	PC / UL94V2		

cd/klm

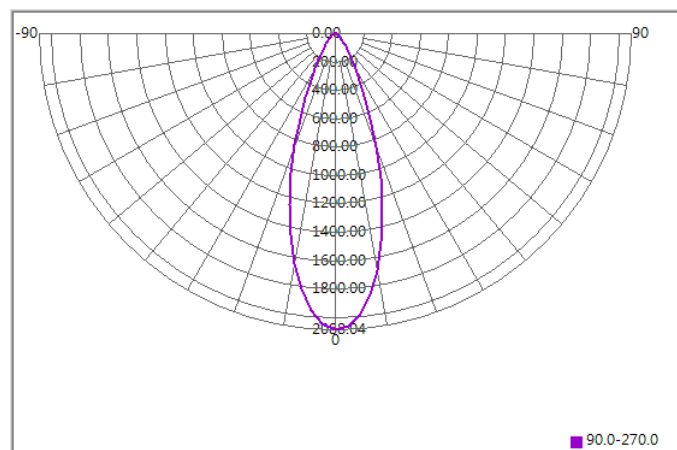

Illuminance At Distances

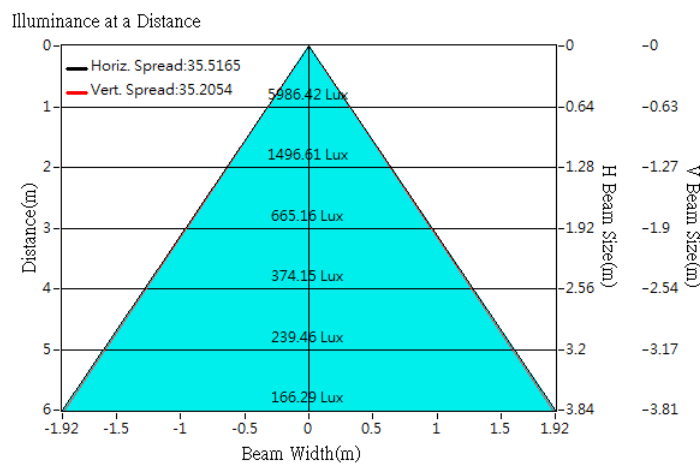



Optical Characteristics

Model Number	CKO-CH15-085040-5005		<p>"H" definition</p> <p>LES CoB</p>
LED	CMT1930		
LES / LED Size	Φ 14.5 mm		
FWHM (D50)	35°		
Field Angle (D10)	65°		
H (distance)	3.65 mm		
Dimension	Φ =85 mm, Thickness=39.7 mm		
Luminous Flux	3153 lm	Measured @ 28.0 W	
Material	PC / UL94V2		

cd/klm

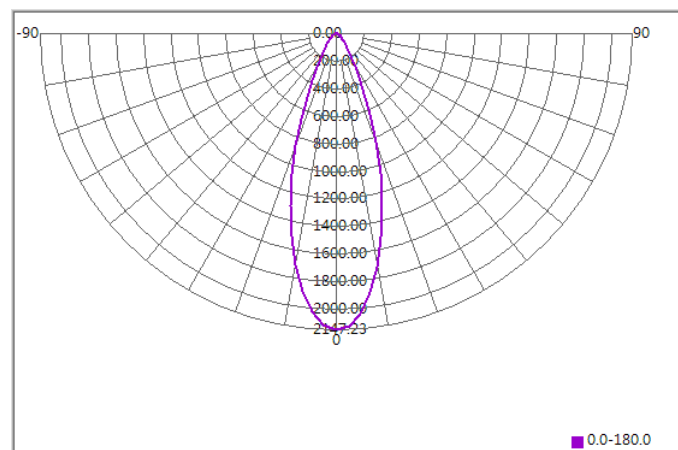

Illuminance At Distances

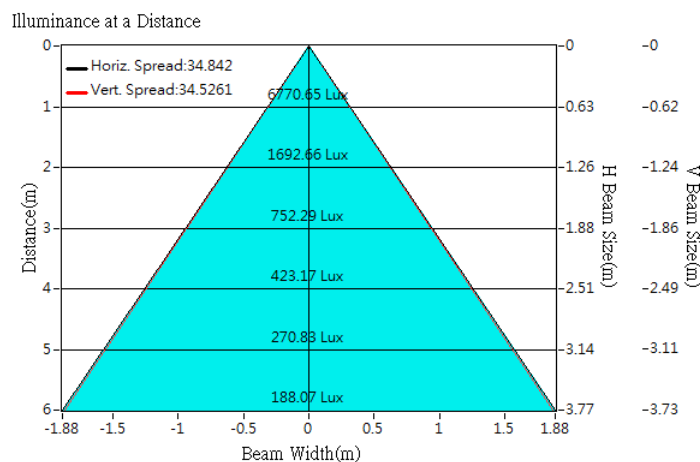



Optical Characteristics

Model Number	CKO-CH15-085040-5005	<p>"H" definition</p> <p>LES CoB</p>
LED	CXA2520	
LES / LED Size	Φ 19 mm	
FWHM (D50)	38°	
Field Angle (D10)	71°	
H (distance)	3.65 mm	
Dimension	Φ =85 mm, Thickness=39.7 mm	
Luminous Flux	1838 lm	
Material	PC / UL94V2	

cd/klm

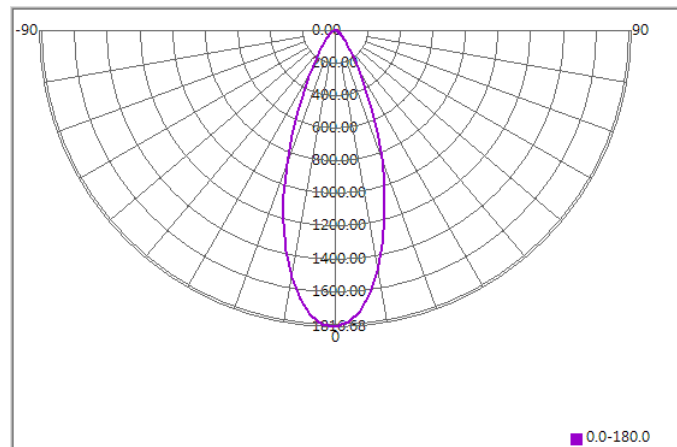

Illuminance At Distances

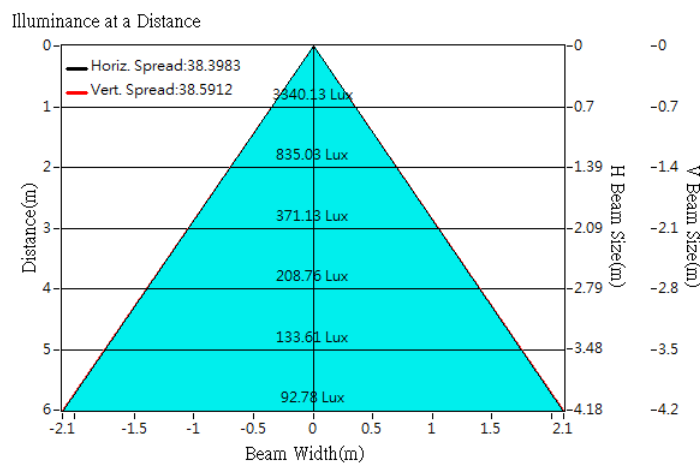



Optical Characteristics

Model Number	CKO-CH15-085040-5005	<p>"H" definition</p> <p>LES CoB</p>
LED	CXA2530	
LES / LED Size	Φ 19 mm	
FWHM (D50)	39°	
Field Angle (D10)	72°	
H (distance)	3.65 mm	
Dimension	Φ =85 mm, Thickness=39.7 mm	
Luminous Flux	2599 lm	
Material	PC / UL94V2	

cd/klm

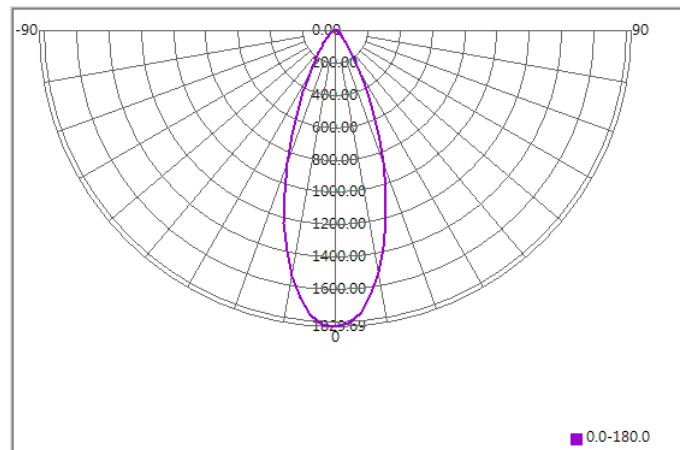

Illuminance At Distances

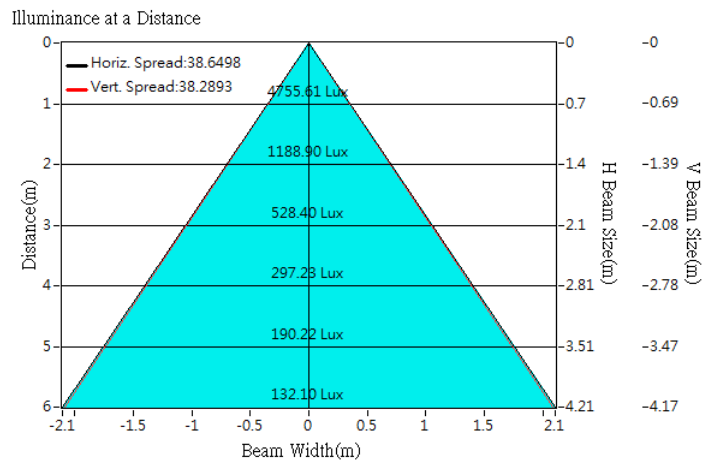



Optical Characteristics

Model Number	CKO-CH15-085040-5005		<p>"H" definition</p>
LED	CREE CXB2530		
LES / LED Size	Φ 19 mm		
FWHM (D50)	39°		
Field Angle (D10)	72°		
H (distance)	3.65 mm		
Dimension	Φ =85 mm, Thickness=39.7 mm		
Luminous Flux	2899 lm	Measured @ 27.6 W	
Material	PC / UL94V2		

cd/klm

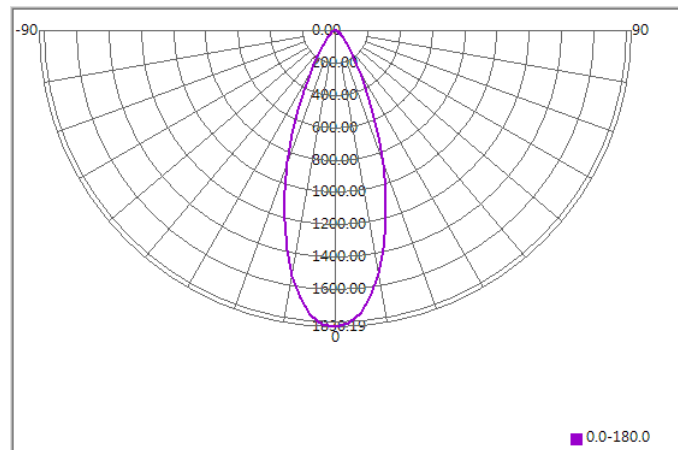

Illuminance At Distances

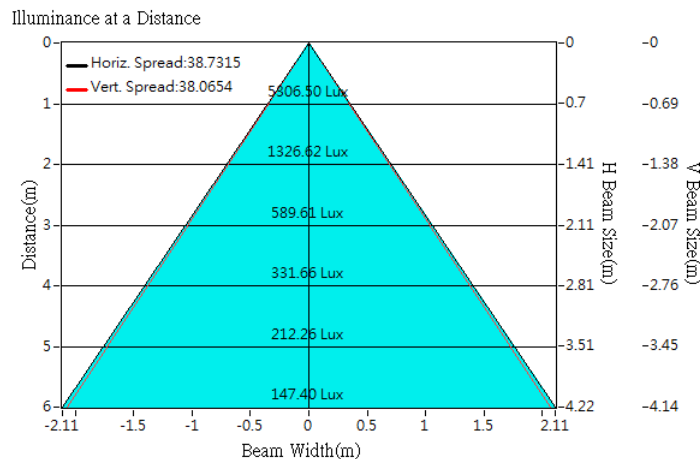



Optical Characteristics

Model Number	CKO-CH15-085040-5005	<p>"H" definition</p>
LED	CXB2540	
LES / LED Size	Φ 19 mm	
FWHM (D50)	40°	
Field Angle (D10)	73°	
H (distance)	3.65 mm	
Dimension	Φ =85 mm, Thickness=39.7 mm	
Luminous Flux	4233 lm	
Material	PC / UL94V2	

cd/klm

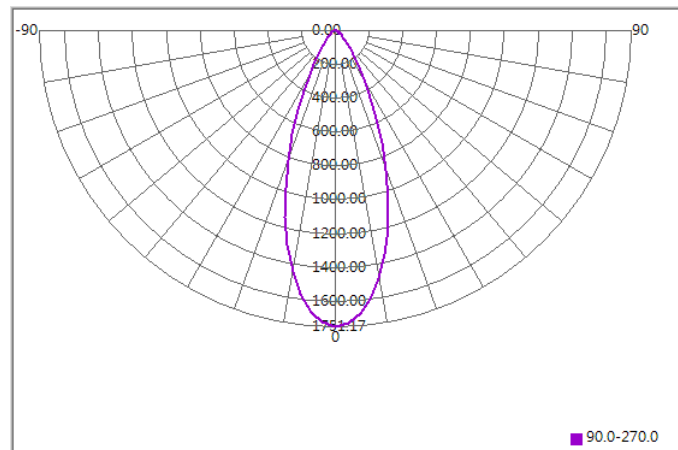

Illuminance At Distances

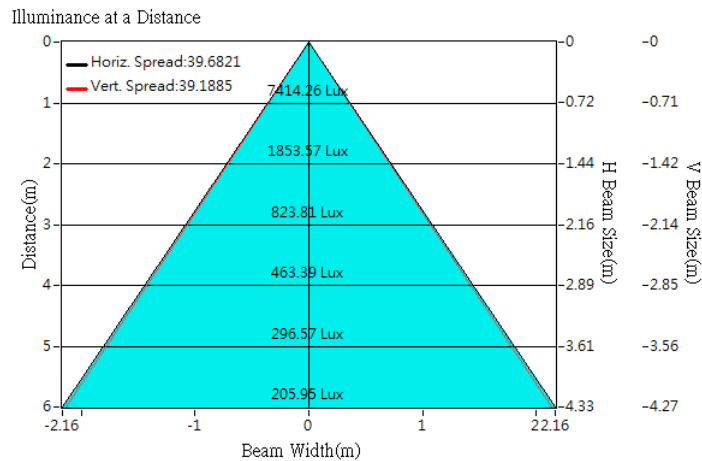



Lens Accessories - CoB Holder

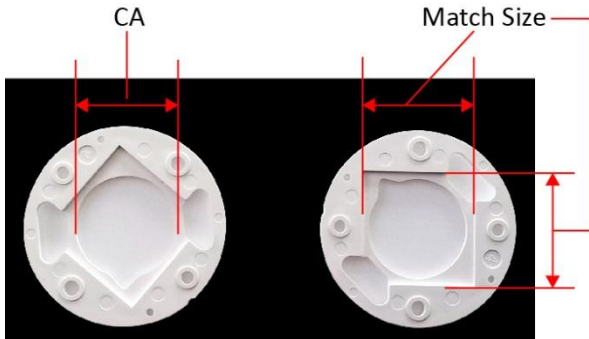

Example of LES Area & LED Size Dimension Locations

Product Model	Match Size (mm)	CA (mm)	Material	Applicability
CKO-HC13-131307-6411	13.6 x 13.6	Φ 7.8	PBT	CREE CXA 13XX
CKO-HC13-161610-6412	16.1 x 16.1	Φ 10.8	PBT	CREE CXA 15XX
CKO-HC13-181816-6413	18.1 x 18.1	Φ 16.4	PBT	CREE CXA 18XX
CKO-HC13-242421-6414	24.1 x 24.1	Φ 21.3	PBT	CREE CXA 25XX
CKO-HC13-272725-6415	27.6 x 27.6	Φ 25.3	PBT	CREE CXA 30XX