



Product Model Number

CKO-CH15-085040-5005

✓ Model Number Definitions

CKO-XXXX-XXXXXX-XXXX



- A. Chun Kuang Optics Corp. Product
- B. Product Type: product abbreviation
Ex:
CH→CoB High Intensity
CC→CoB Compact
CS→Soft Shading for CoB LED
HC→Holder for CoB LED

- C. Identity Code
- D. Lens / Fixture Size
Ex: 075026=Φ75mm / Thickness=26mm (round up)
- C. Serial Numbers

The lens datasheet is applicable for **Philips LED**, that manufactured by Chun Kuang Optics Corp.

✓ Dimensions (mm) : Φ85 x 39.7

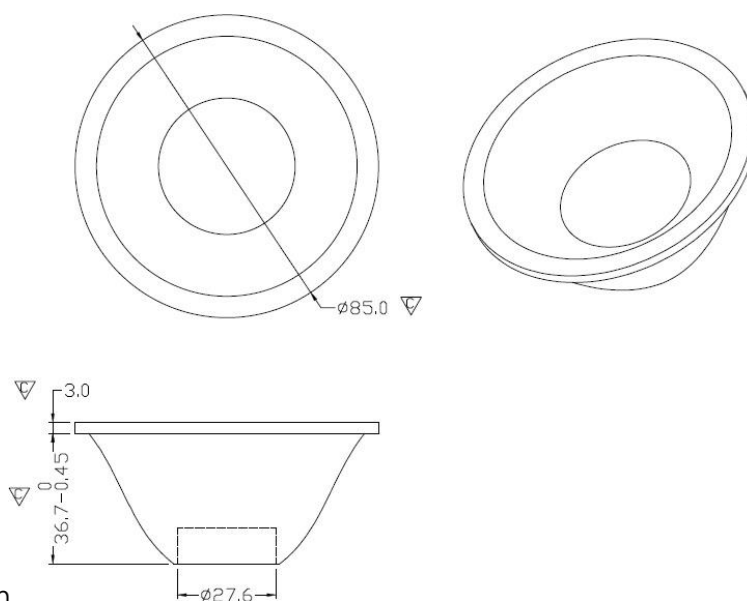

▽:Critical Dimension



Optical Characteristics

Model Number	CKO-CH15-085040-5005		<p>"H" definition</p> <p>LES CoB</p>
LED	Fortimo SLM PW 1204 L09 G7		
LES / LED Size	Φ 9 mm		
FWHM (D50)	31°		
Field Angle (D10)	60°		
H (distance)	3.65mm		
Dimension	Φ =85 mm, Thickness=39.7 mm		
Luminous Flux	2098 lm	Measured @ 26.7 W	
Material	PC / UL94V2		

cd/klm

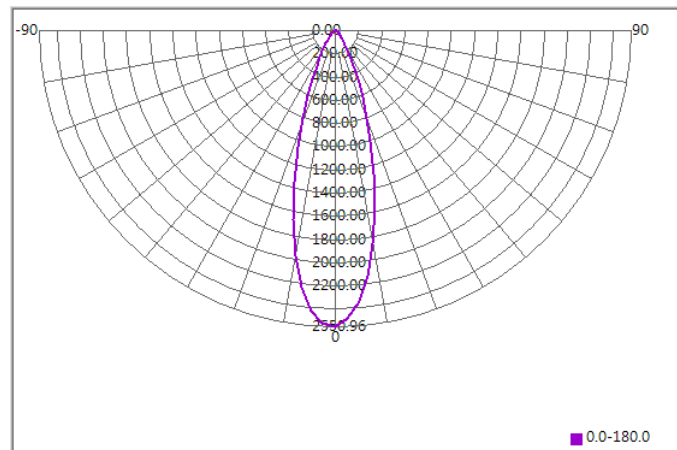

Illuminance At Distances

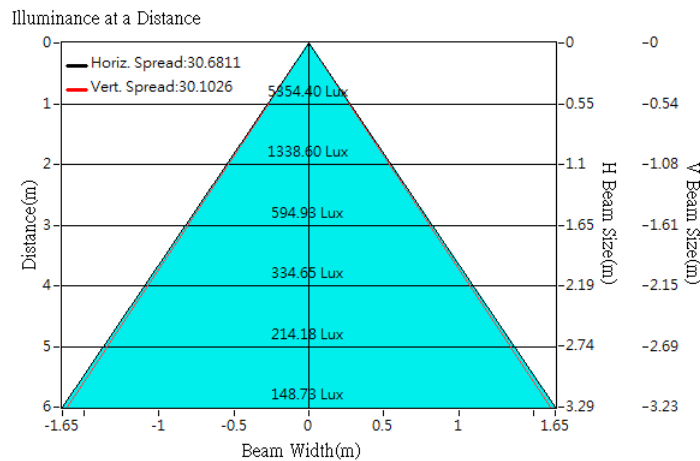



Optical Characteristics

Model Number	CKO-CH15-085040-5005		<p>"H" definition</p>
LED	Fortimo SLM 1202 L09 G7N		
LES / LED Size	Φ 9.8 mm		
FWHM (D50)	32°		
Field Angle (D10)	61°		
H (distance)	3.65mm		
Dimension	Φ =85 mm, Thickness=39.7 mm		
Luminous Flux	846 lm	Measured @ 6.0 W	
Material	PC / UL94V2		

cd/klm

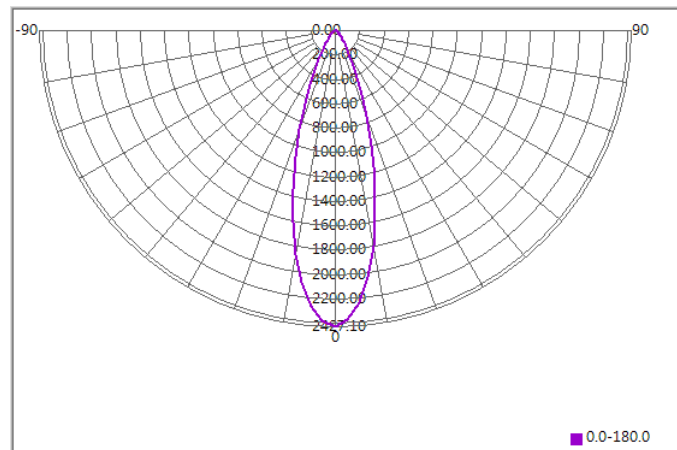

Illuminance At Distances

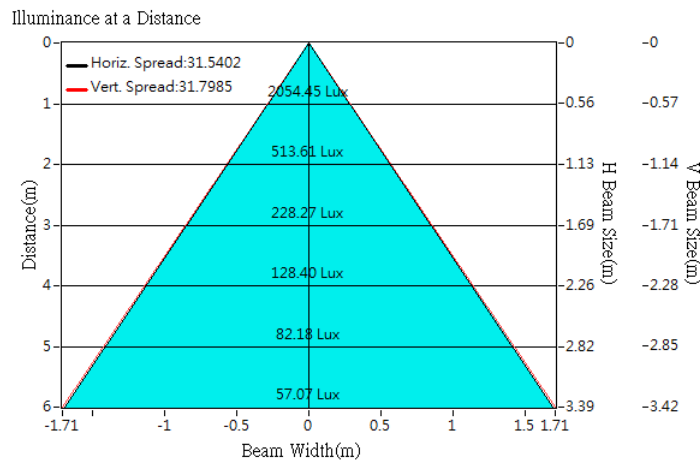



Optical Characteristics

Model Number	CKO-CH15-085040-5005		
LED	Fortimo SLM 1203 L09 G7N		
LES / LED Size	Φ 9.8 mm		
FWHM (D50)	31°		
Field Angle (D10)	60°		
H (distance)	3.65mm		
Dimension	Φ =85 mm, Thickness=39.7 mm		
Luminous Flux	1252 lm	Measured @ 9.2 W	
Material	PC / UL94V2		

cd/klm

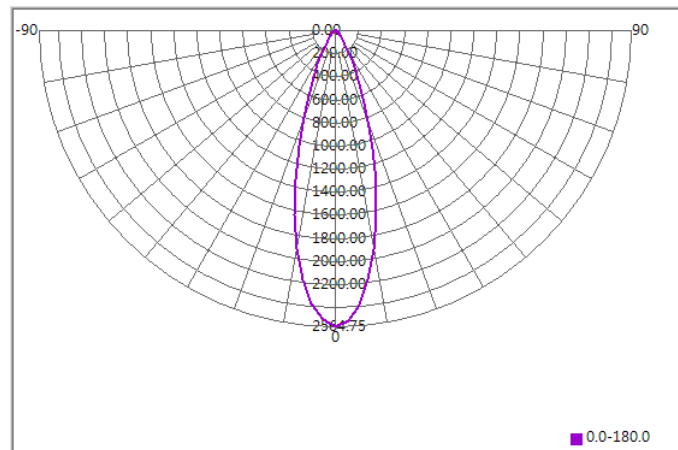

Illuminance At Distances

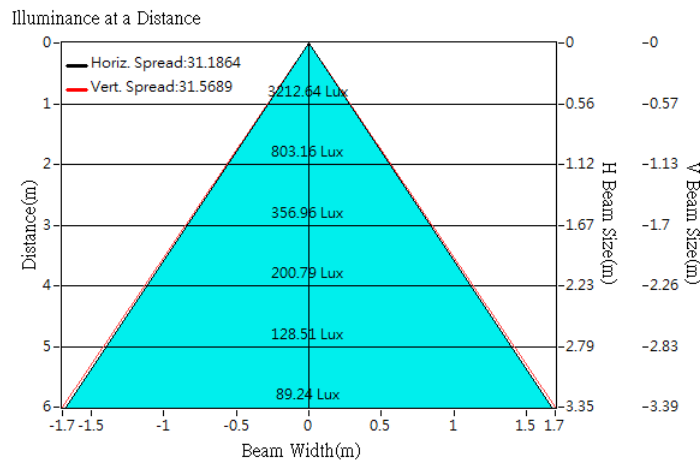



Optical Characteristics

Model Number	CKO-CH15-085040-5005		<p>"H" definition</p> <p>LES</p> <p>CoB</p> <p>"H" mm (distance)</p>
LED	Fortimo SLM 1204 L09 G7N		
LES / LED Size	Φ 9.8 mm		
FWHM (D50)	32°		
Field Angle (D10)	61°		
H (distance)	3.65mm		
Dimension	Φ =85 mm, Thickness=39.7 mm		
Luminous Flux	1673 lm	Measured @ 12.3 W	
Material	PC / UL94V2		

cd/klm

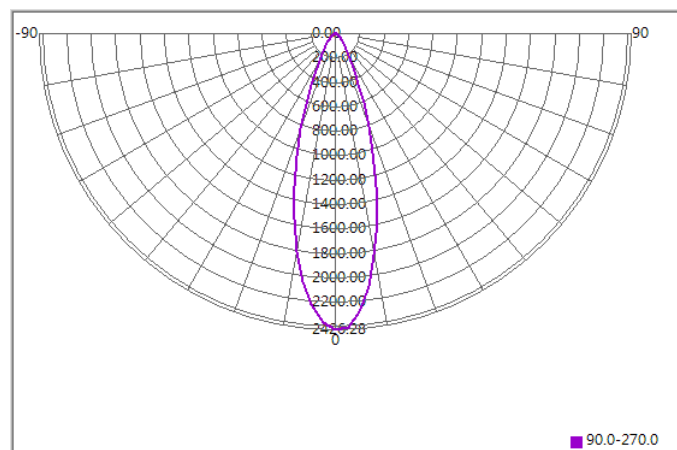

Illuminance At Distances

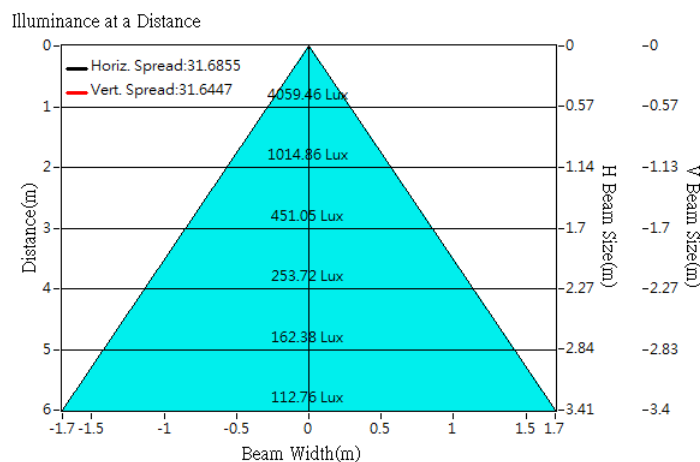



Optical Characteristics

Model Number	CKO-CH15-085040-5005		<p>"H" definition</p> <p>LES</p> <p>CoB</p>
LED	Fortimo SLM 830 1205 L13 G7		
LES / LED Size	Φ 13 mm		
FWHM (D50)	35°		
Field Angle (D10)	65°		
H (distance)	3.65 mm		
Dimension	Φ =85 mm, Thickness=39.7 mm		
Luminous Flux	1793 lm	Measured @ 17.5 W	
Material	PC / UL94V2		

cd/klm

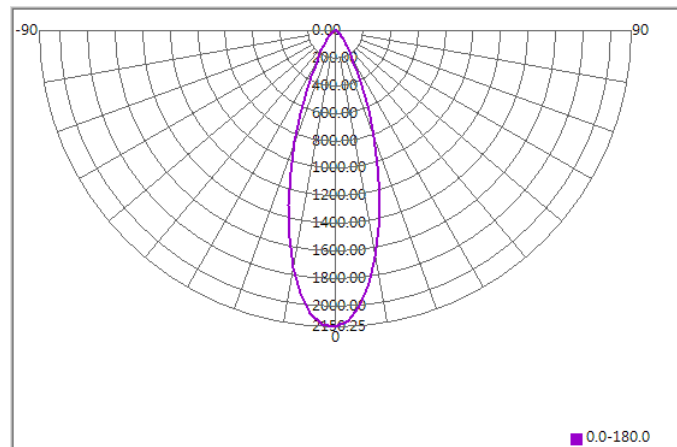

Illuminance At Distances

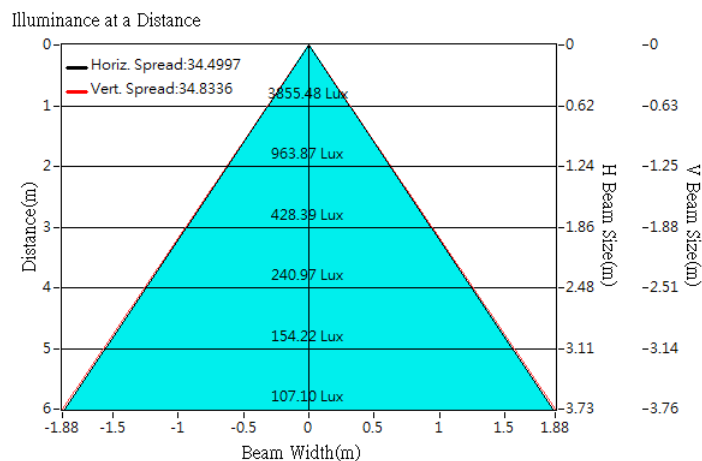



Optical Characteristics

Model Number	CKO-CH15-085040-5005		<p>"H" definition</p> <p>LES</p> <p>CoB</p> <p>"H" mm (distance)</p>
LED	Fortimo SLM PW 1205 L13 G6		
LES / LED Size	Φ 13 mm		
FWHM (D50)	35°		
Field Angle (D10)	65°		
H (distance)	3.65mm		
Dimension	Φ =85 mm, Thickness=39.7 mm		
Luminous Flux	1935 lm	Measured @ 17.8 W	
Material	PC / UL94V2		

cd/klm

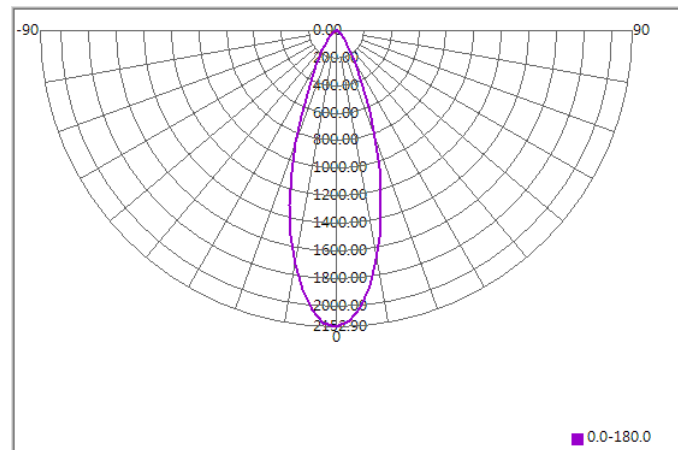

Illuminance At Distances

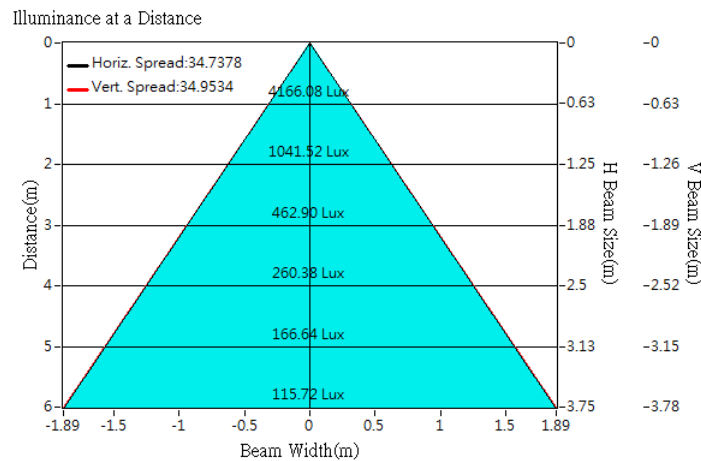



Optical Characteristics

Model Number	CKO-CH15-085040-5005		
LED	Fortimo SLM C 1205 L13 2024 G6_DL		
LES / LED Size	Φ 13 mm		
FWHM (D50)	35°		
Field Angle (D10)	64°		
H (distance)	3.5mm		
Dimension	Φ =85 mm, Thickness=39.7 mm		
Luminous Flux	2124 lm	Measured @ 17.4 W	
Material	PC / UL94V2		

cd/klm

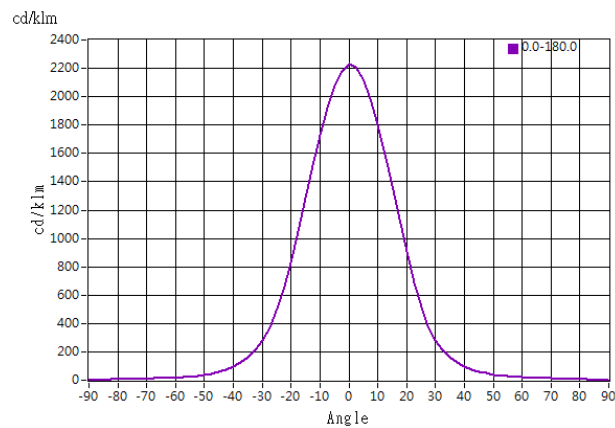

Illuminance At Distances

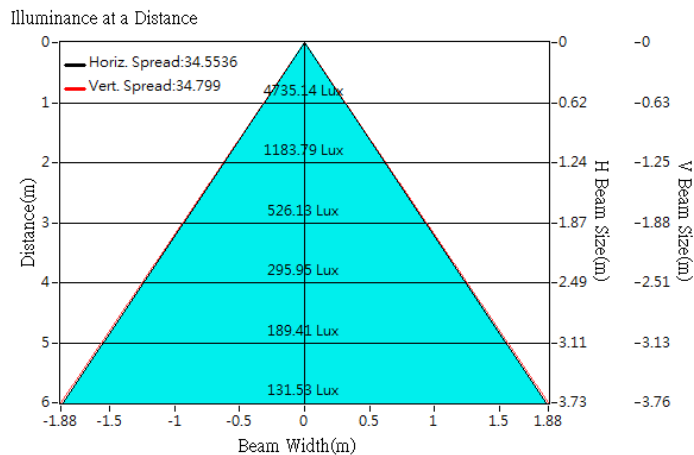



Optical Characteristics

Model Number	CKO-CH15-085040-5005		
LED	Fortimo SLM C 1205 L13 2024 G6_PI		
LES / LED Size	Φ 13 mm		
FWHM (D50)	35°		
Field Angle (D10)	64°		
H (distance)	3.5mm		
Dimension	Φ =85 mm, Thickness=39.7 mm		
Luminous Flux	2124 lm	Measured @ 17.4 W	
Material	PC / UL94V2		

cd/klm

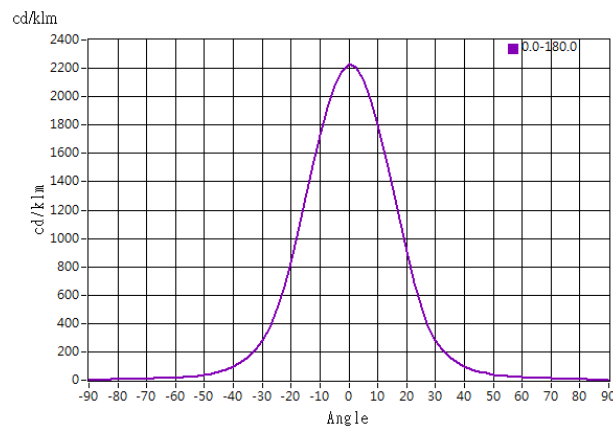

Illuminance At Distances

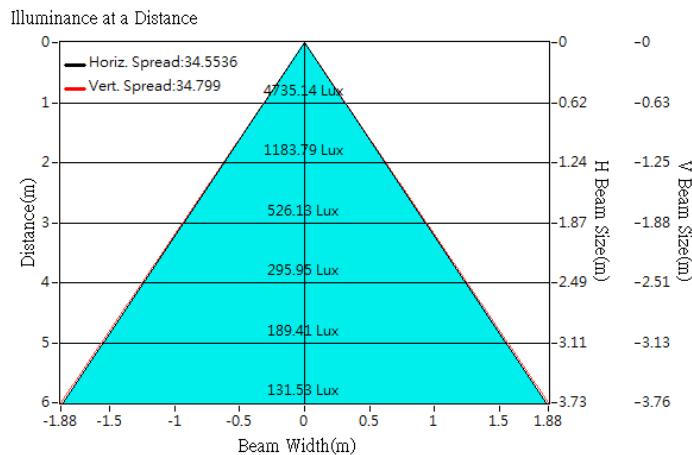



Optical Characteristics

Model Number	CKO-CH15-085040-5005		
LED	Fortimo SLM 1205 L15 G7N		
LES / LED Size	Φ 14.5 mm		
FWHM (D50)	35°		
Field Angle (D10)	67°		
H (distance)	3.65mm		
Dimension	Φ =85 mm, Thickness=39.7 mm		
Luminous Flux	2078 lm	Measured @ 15.4 W	
Material	PC / UL94V2		

cd/klm

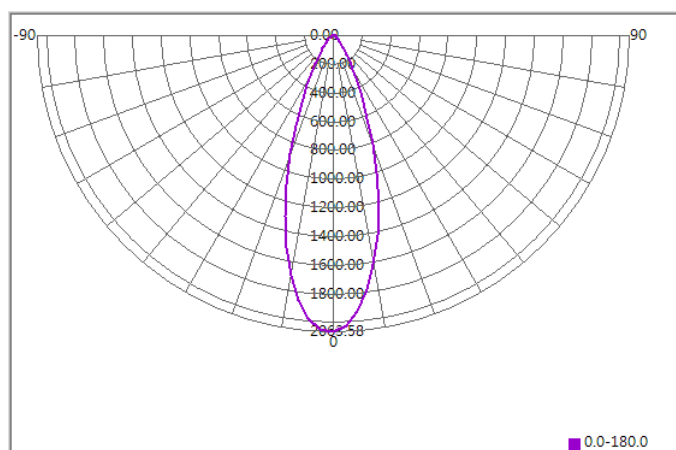

Illuminance At Distances

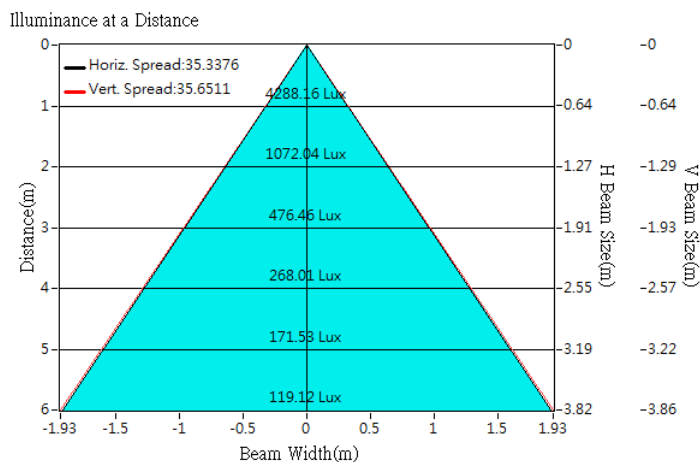



Optical Characteristics

Model Number	CKO-CH15-085040-5005	<p>"H" definition</p> <p>LES</p> <p>CoB</p> <p>"H" mm (distance)</p>
LED	Fortimo SLM 1206 L15 G7N	
LES / LED Size	Φ 14.5 mm	
FWHM (D50)	36°	
Field Angle (D10)	67°	
H (distance)	3.65mm	
Dimension	Φ =85 mm, Thickness=39.7 mm	
Luminous Flux	2524 lm	
Material	PC / UL94V2	

cd/klm

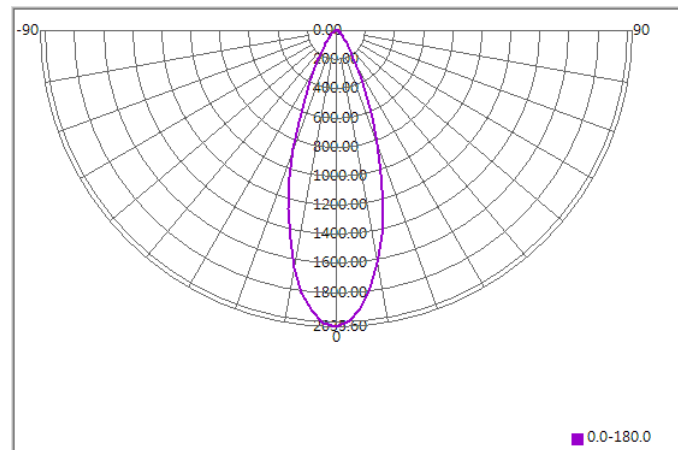

Illuminance At Distances

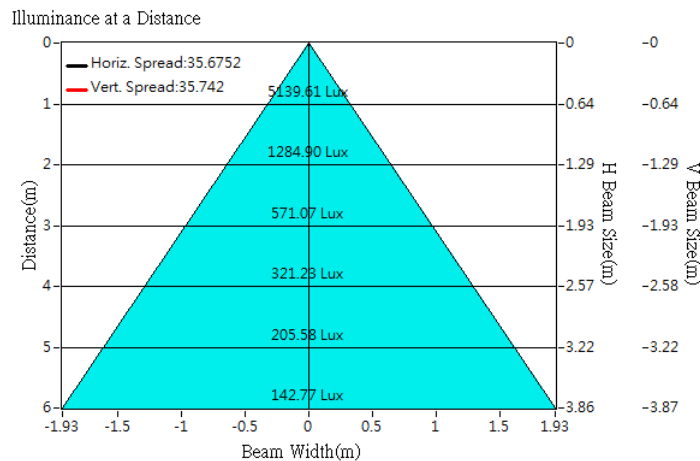



Optical Characteristics

Model Number	CKO-CH15-085040-5005		
LED	Fortimo SLM 1208 L15 G7N		
LES / LED Size	Φ 14.5 mm		
FWHM (D50)	36°		
Field Angle (D10)	68°		
H (distance)	3.65mm		
Dimension	Φ =85 mm, Thickness=39.7 mm		
Luminous Flux	3522 lm	Measured @ 25 W	
Material	PC / UL94V2		

cd/klm

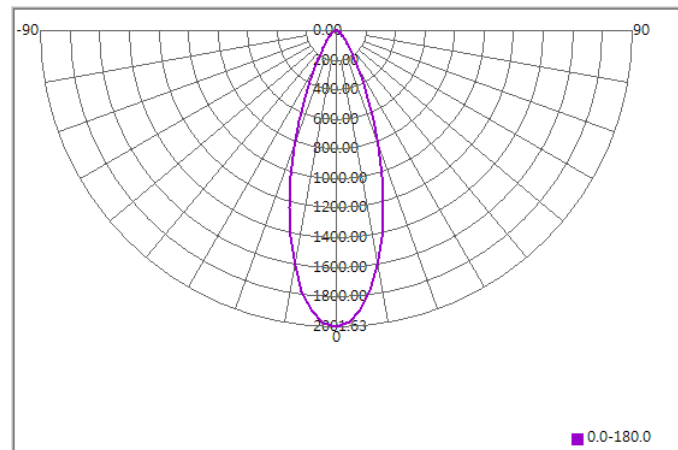

Illuminance At Distances

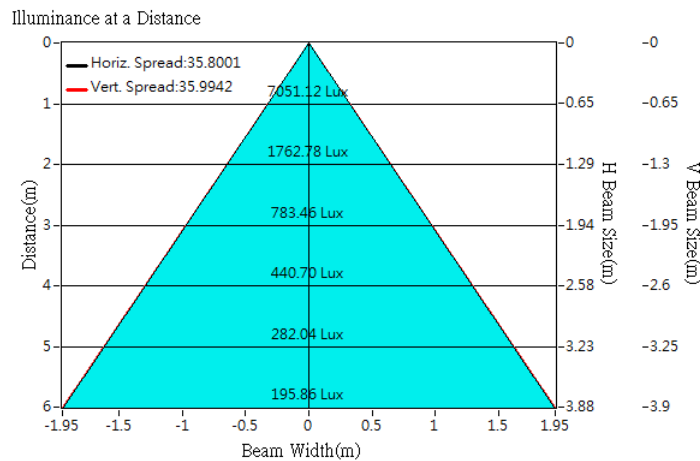



Optical Characteristics

Model Number	CKO-CH15-085040-5005	<p>"H" definition</p> <p>LES CoB "H" mm (distance)</p>
LED	Fortimo SLM 1210 L15 G7N	
LES / LED Size	Φ 14.5 mm	
FWHM (D50)	36°	
Field Angle (D10)	67°	
H (distance)	3.65mm	
Dimension	Φ =85 mm, Thickness=39.7 mm	
Luminous Flux	4035 lm Measured @ 31 W	
Material	PC / UL94V2	

cd/klm

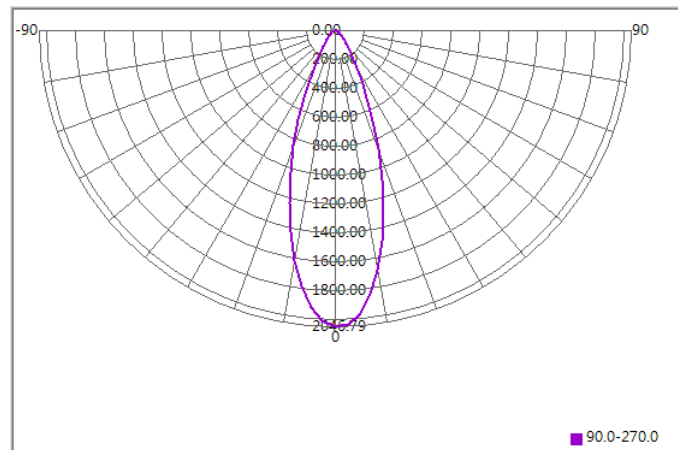

Illuminance At Distances

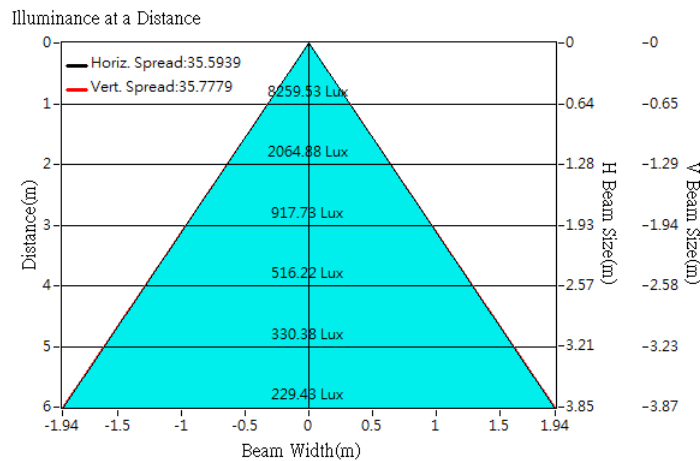



Optical Characteristics

Model Number	CKO-CH15-085040-5005		<p>"H" definition</p> <p>LES CoB</p>
LED	Fortimo SLM 1208 L15 G7		
LES / LED Size	Φ 15 mm		
FWHM (D50)	36°		
Field Angle (D10)	67°		
H (distance)	3.65mm		
Dimension	Φ =85 mm, Thickness=39.7 mm		
Luminous Flux	2749 lm	Measured @ 26.2 W	
Material	PC / UL94V2		

cd/klm

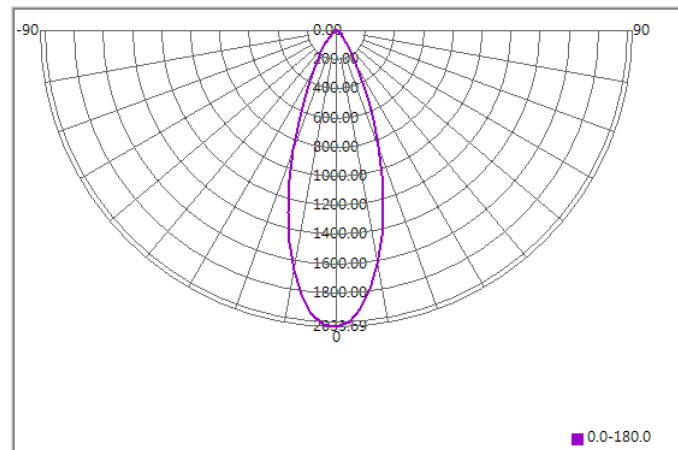

Illuminance At Distances

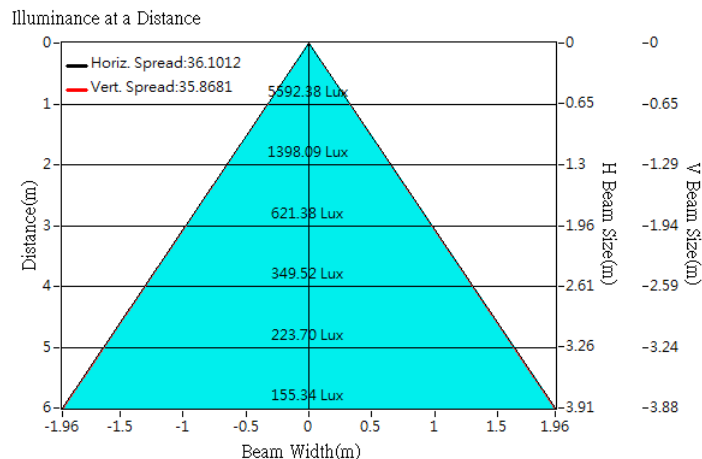



Optical Characteristics

Model Number	CKO-CH15-085040-5005	<p>"H" definition</p> <p>LES CoB</p>
LED	Fortimo SLM 1208 L15 G6	
LES / LED Size	Φ 15 mm	
FWHM (D50)	36°	
Field Angle (D10)	66°	
H (distance)	3.65mm	
Dimension	Φ =85 mm, Thickness=39.7 mm	
Luminous Flux	2390 lm	
Material	PC / UL94V2	

cd/klm

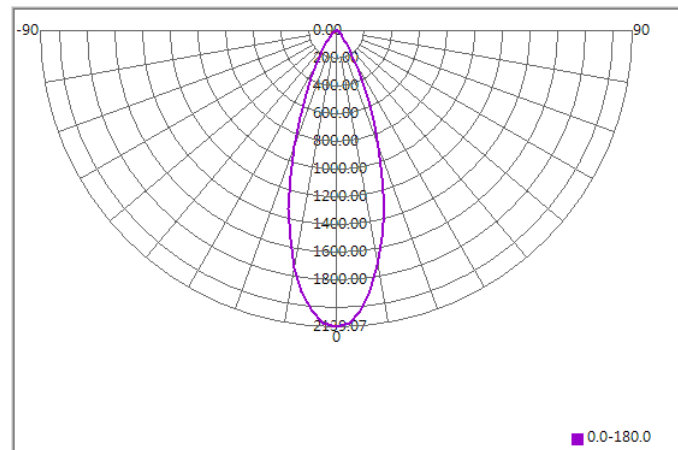

Illuminance At Distances

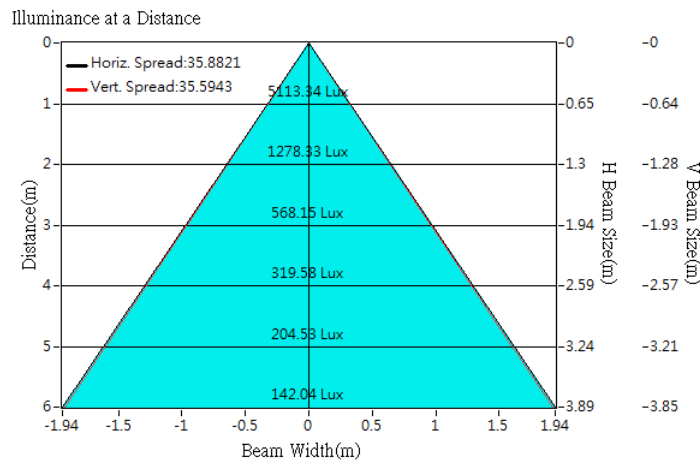



Optical Characteristics

Model Number	CKO-CH15-085040-5005		
LED	Fortimo SLM C 1208 L15 2024 G6_DL		
LES / LED Size	Φ 15 mm		
FWHM (D50)	36°		
Field Angle (D10)	67°		
H (distance)	3.5mm		
Dimension	Φ =85 mm, Thickness=39.7 mm		
Luminous Flux	2509 lm	Measured @ 26.9 W	
Material	PC / UL94V2		

cd/klm

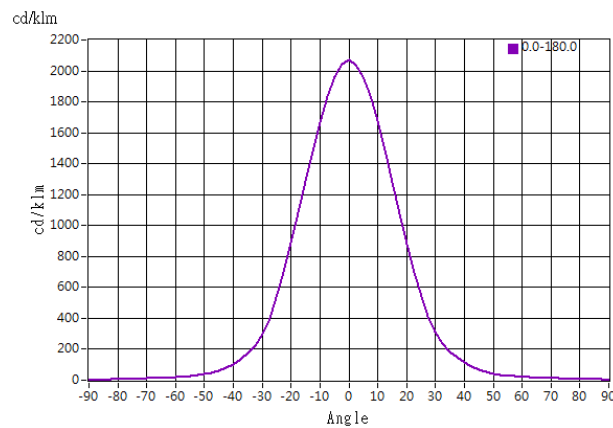

Illuminance At Distances

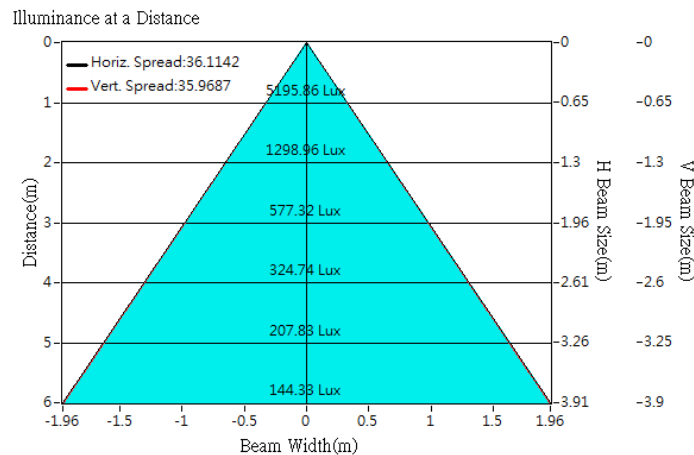



Optical Characteristics

Model Number	CKO-CH15-085040-5005		
LED	Fortimo SLM C 1208 L15 2024 G6_PI		
LES / LED Size	Φ 15 mm		
FWHM (D50)	36°		
Field Angle (D10)	67°		
H (distance)	3.5mm		
Dimension	Φ =85 mm, Thickness=39.7 mm		
Luminous Flux	2509 lm	Measured @ 26.9 W	
Material	PC / UL94V2		

cd/klm

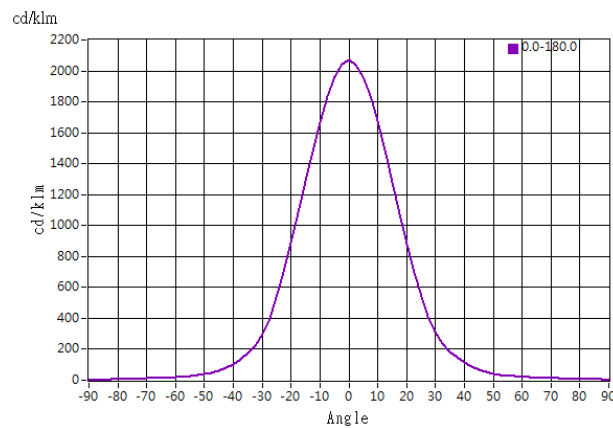

Illuminance At Distances

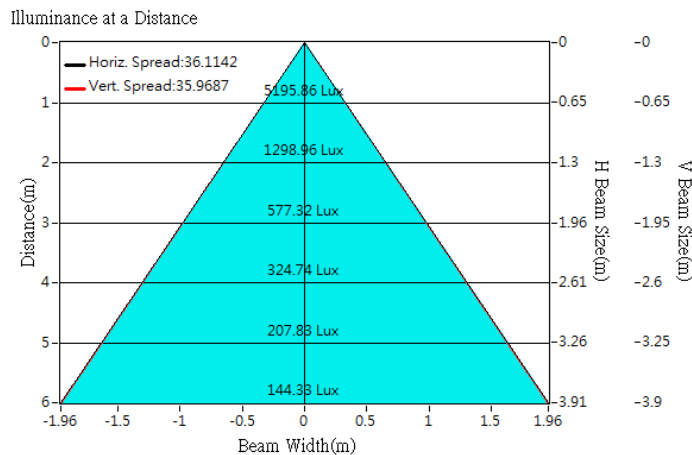



Optical Characteristics

Model Number	CKO-CH15-085040-5005		
LED	Fortimo SLM C 1211 L19 2828 G6_DL		
LES / LED Size	Φ 19 mm		
FWHM (D50)	40°		
Field Angle (D10)	74°		
H (distance)	3.5mm		
Dimension	Φ =85 mm, Thickness=39.7 mm		
Luminous Flux	2652 lm	Measured @ 35.7 W	
Material	PC / UL94V2		

cd/klm

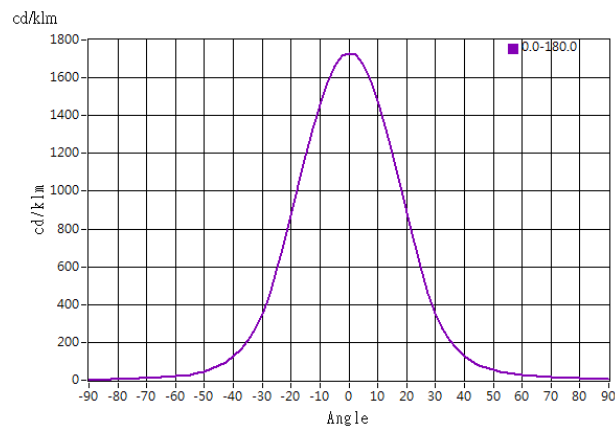

Illuminance At Distances

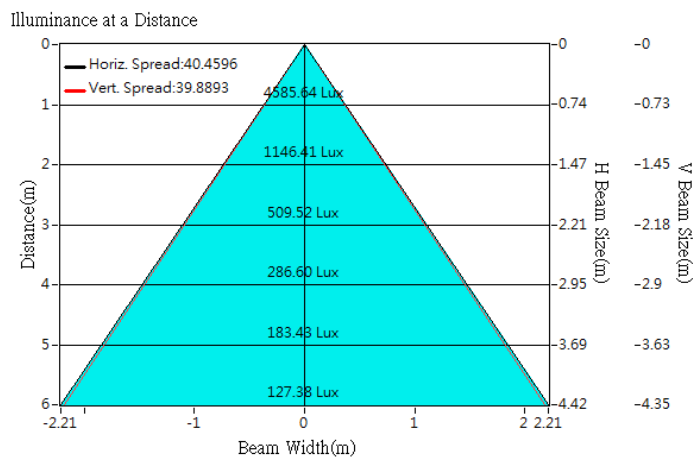



Optical Characteristics

Model Number	CKO-CH15-085040-5005		
LED	Fortimo SLM C 1211 L19 2828 G6_PI		
LES / LED Size	Φ 19 mm		
FWHM (D50)	40°		
Field Angle (D10)	74°		
H (distance)	3.5mm		
Dimension	Φ =85 mm, Thickness=39.7 mm		
Luminous Flux	2652 lm	Measured @ 35.7 W	
Material	PC / UL94V2		

cd/klm

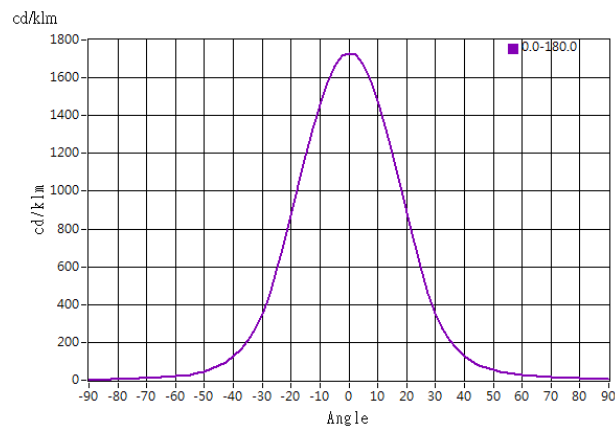

Illuminance At Distances

