



Product Model Number

CKO-CH15-085040-5007

✓ Model Number Definitions

CKO-XXXX-XXXXXX-XXXX



- A. Chun Kuang Optics Corp. Product
- B. Product Type: product abbreviation
Ex:
CH→CoB High Intensity
CC→CoB Compact
CS→Soft Shading for CoB LED
HC→Holder for CoB LED

- C. Identity Code
- D. Lens / Fixture Size
Ex: 075026=Φ75mm / Thickness=26mm (round up)
- C. Serial Numbers

The lens datasheet is applicable for **Philips LED**, that manufactured by Chun Kuang Optics Corp.

✓ Dimensions (mm) : Φ85 x 39.7

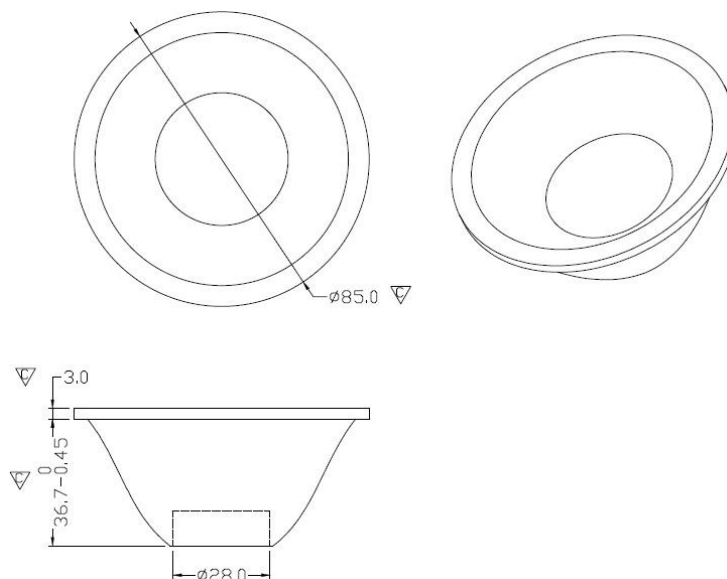

▽:Critical Dimension



✓ Optical Characteristics – Angle Performances

Philips	LED LES (mm)	FWHM (degrees)	Field Angle (degrees)
Fortimo SLM PW 1204 L09 G7	Φ9	40°	68°
Fortimo SLM 1202 L09 G7N	Φ9.8	40°	69°
Fortimo SLM 1203 L09 G7N	Φ9.8	40°	67°
Fortimo SLM 1204 L09 G7N	Φ9.8	40°	68°
Fortimo SLM 1205 L13 G7	Φ13	41°	71°
Fortimo SLM PW 1205 L13 G6	Φ13	41°	71°
Fortimo SLM PW 1205 L13 G6_DL	Φ13	41°	70°
Fortimo SLM PW 1205 L13 G6_PI	Φ13	41°	70°
Fortimo SLM 1205 L15 G7N	Φ14.5	41°	71°
Fortimo SLM 1206 L15 G7N	Φ14.5	42°	72°
Fortimo SLM 1208 L15 G7N	Φ14.5	42°	72°
Fortimo SLM 1210 L15 G7N	Φ14.5	42°	72°
Fortimo SLM 1208 L15 G7	Φ15	42°	72°
Fortimo SLM 1208 L15 G6	Φ15	41°	71°
Fortimo SLM 1208 L15 G6_DL	Φ15	42°	72°
Fortimo SLM 1208 L15 G6_PI	Φ15	42°	72°
Fortimo SLM 1211 L19 G6_DL	Φ19	44°	77°
Fortimo SLM 1211 L19 G6_PI	Φ19	44°	77°



Optical Characteristics

Model Number	CKO-CH15-085040-5007		<p>"H" definition</p> <p>LES</p> <p>CoB</p> <p>"H" mm (distance)</p>
LED	Fortimo SLM PW 1204 L09 G7		
LES / LED Size	Φ 9 mm		
FWHM (D50)	40°		
Field Angle (D10)	68°		
H (distance)	3.65 mm		
Dimension	Φ =85 mm, Thickness=39.7 mm		
Luminous Flux	2133 lm	Measured @ 26.7 W	
Material	PC / UL94V2		

cd/klm

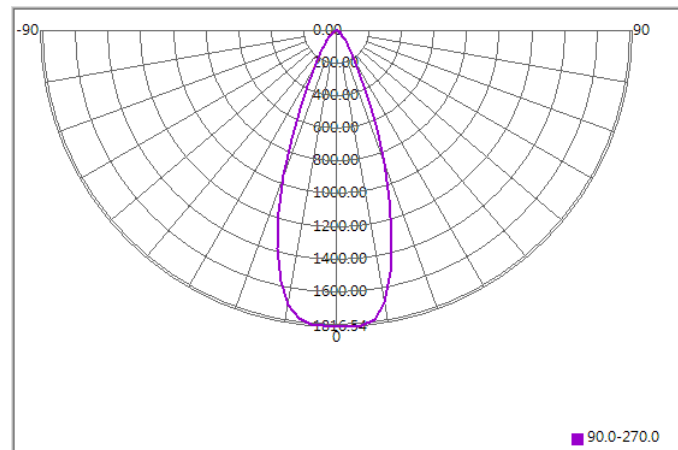

Illuminance At Distances

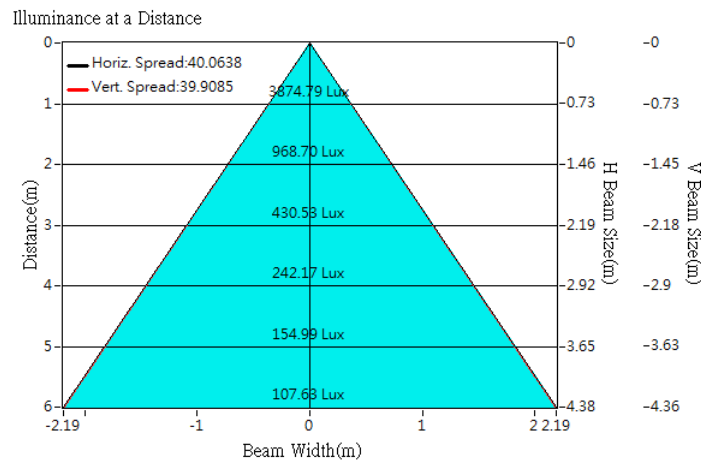



Optical Characteristics

Model Number	CKO-CH15-085040-5007		
LED	Fortimo SLM 1202 L09 G7N		
LES / LED Size	Φ 9.8 mm		
FWHM (D50)	40°		
Field Angle (D10)	69°		
H (distance)	3.65mm		
Dimension	Φ =85 mm, Thickness=39.7 mm		
Luminous Flux	860 lm	Measured @ 6.1 W	
Material	PC / UL94V2		

cd/klm

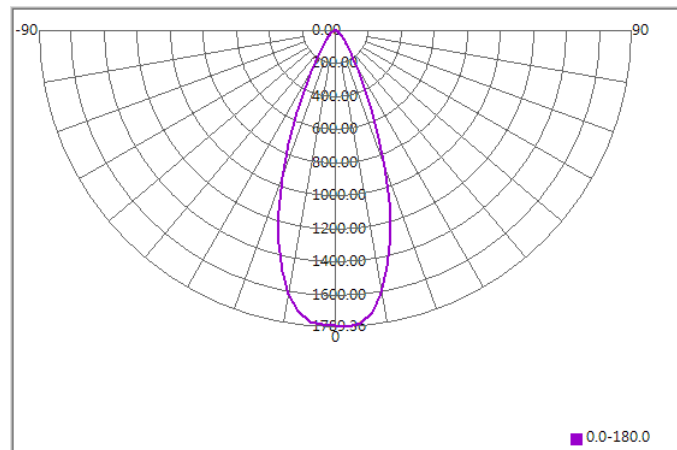

Illuminance At Distances

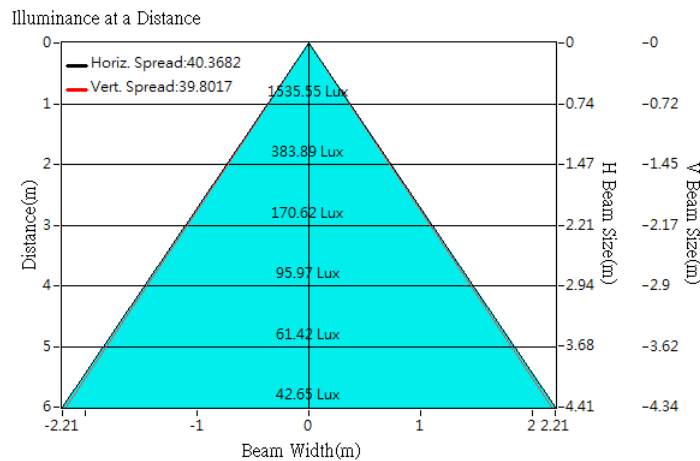



Optical Characteristics

Model Number	CKO-CH15-085040-5007		
LED	Fortimo SLM 1203 L09 G7N		
LES / LED Size	Φ 9.8 mm		
FWHM (D50)	40°		
Field Angle (D10)	67°		
H (distance)	3.65mm		
Dimension	Φ =85 mm, Thickness=39.7 mm		
Luminous Flux	1253 lm	Measured @ 9.2 W	
Material	PC / UL94V2		

cd/klm

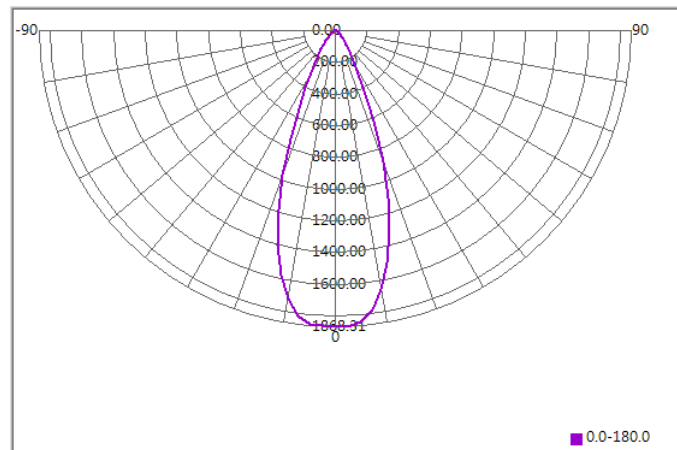

Illuminance At Distances

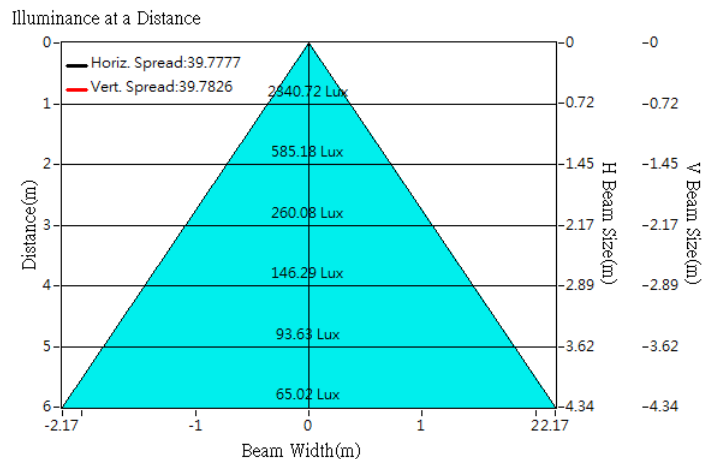



Optical Characteristics

Model Number	CKO-CH15-085040-5007		
LED	Fortimo SLM 1204 L09 G7N		
LES / LED Size	Φ 9.8 mm		
FWHM (D50)	40°		
Field Angle (D10)	68°		
H (distance)	3.65mm		
Dimension	Φ =85 mm, Thickness=39.7 mm		
Luminous Flux	1686 lm	Measured @ 12.3 W	
Material	PC / UL94V2		

cd/klm

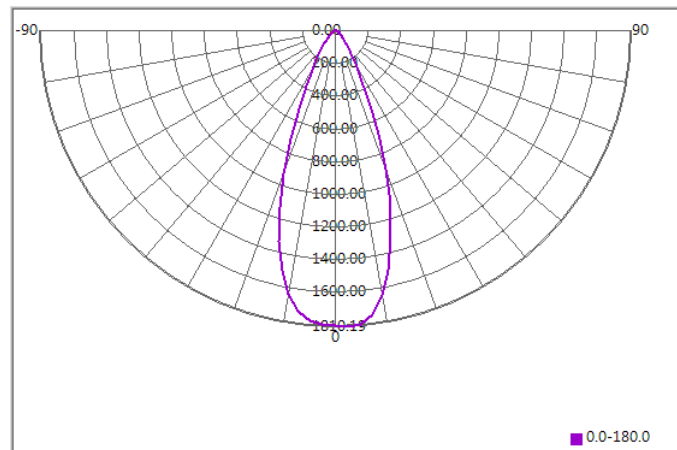

Illuminance At Distances

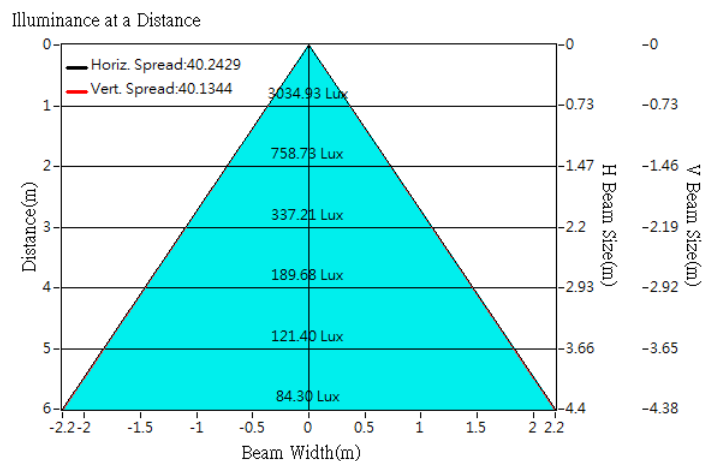



Optical Characteristics

Model Number	CKO-CH15-085040-5007		<p>"H" definition</p> <p>LES</p> <p>CoB</p>
LED	Fortimo SLM 830 1205 L13 G7		
LES / LED Size	Φ 13 mm		
FWHM (D50)	41°		
Field Angle (D10)	71°		
H (distance)	3.65 mm		
Dimension	Φ =85 mm, Thickness=39.7 mm		
Luminous Flux	1816 lm	Measured @ 17.6 W	
Material	PC / UL94V2		

cd/klm

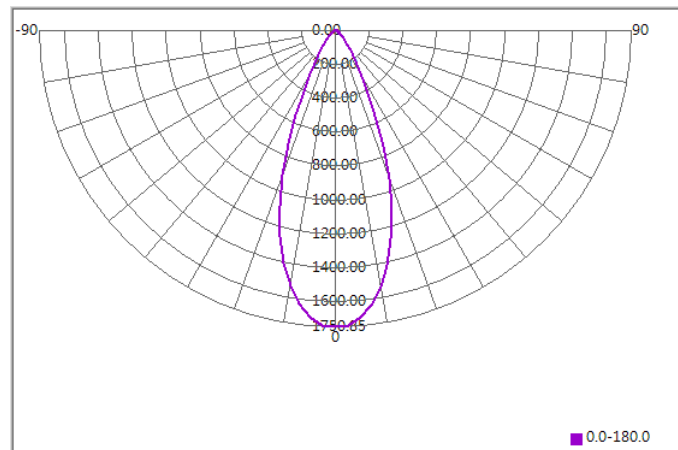

Illuminance At Distances

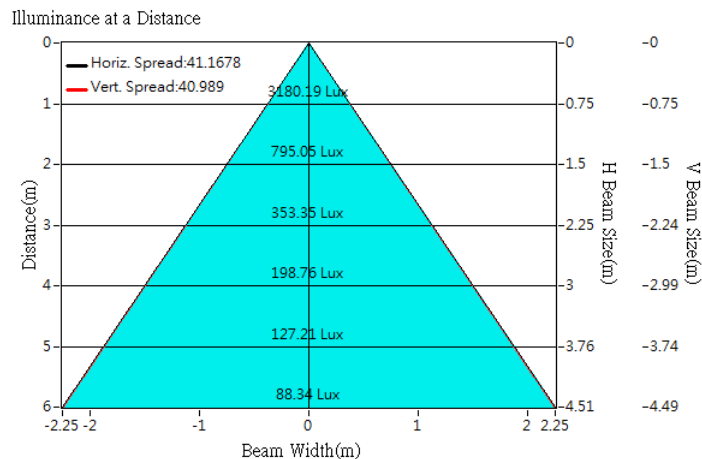



Optical Characteristics

Model Number	CKO-CH15-085040-5007		
LED	Fortimo SLM PW 1205 L13 G6		
LES / LED Size	Φ 13 mm		
FWHM (D50)	41°		
Field Angle (D10)	71°		
H (distance)	3.65mm		
Dimension	Φ =85 mm, Thickness=39.7 mm		
Luminous Flux	1948 lm	Measured @ 17.8 W	
Material	PC / UL94V2		

cd/klm

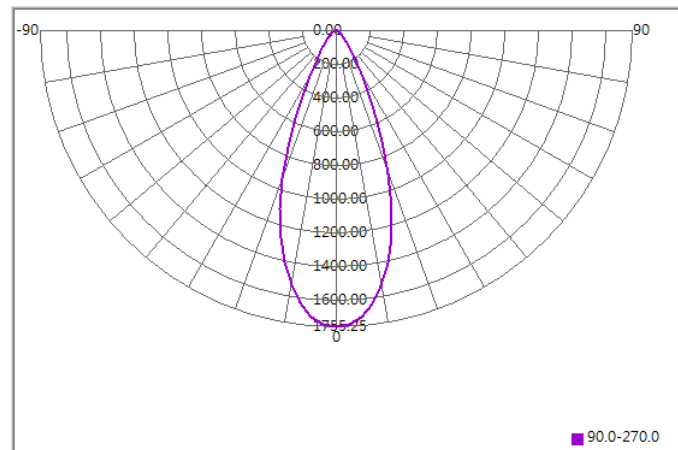

Illuminance At Distances

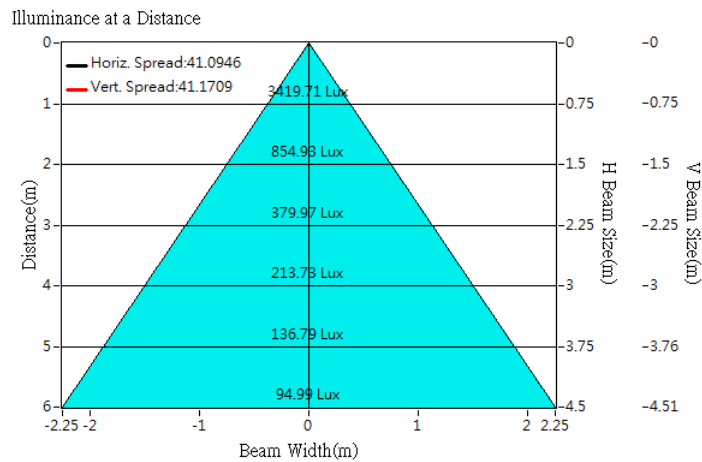



Optical Characteristics

Model Number	CKO-CH15-085040-5007		
LED	Fortimo SLM C 1205 L13 2024 G6_DL		
LES / LED Size	Φ 13 mm		
FWHM (D50)	41°		
Field Angle (D10)	70°		
H (distance)	3.5mm		
Dimension	Φ =85 mm, Thickness=39.7 mm		
Luminous Flux	2150 lm	Measured @ 17.4 W	
Material	PC / UL94V2		

cd/klm

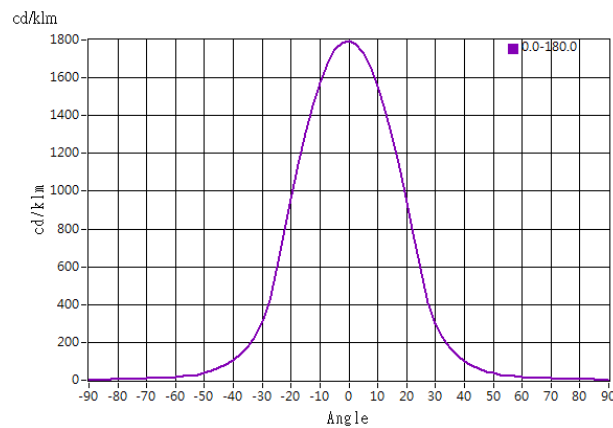

Illuminance At Distances

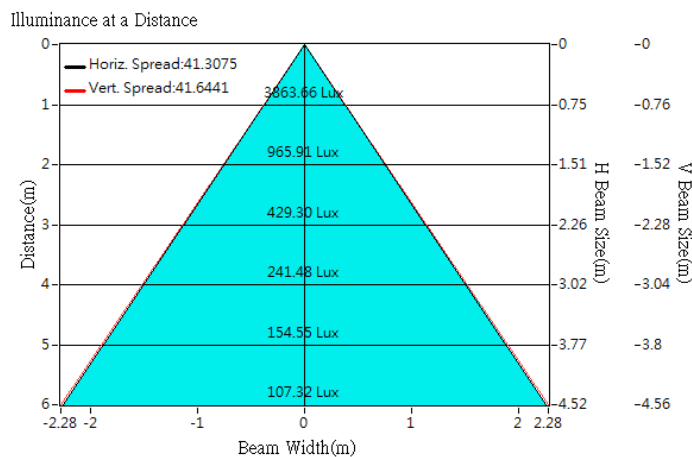



Optical Characteristics

Model Number	CKO-CH15-085040-5007		
LED	Fortimo SLM C 1205 L13 2024 G6_PI		
LES / LED Size	Φ 13 mm		
FWHM (D50)	41°		
Field Angle (D10)	70°		
H (distance)	3.5mm		
Dimension	Φ =85 mm, Thickness=39.7 mm		
Luminous Flux	2150 lm	Measured @ 17.3 W	
Material	PC / UL94V2		

cd/klm

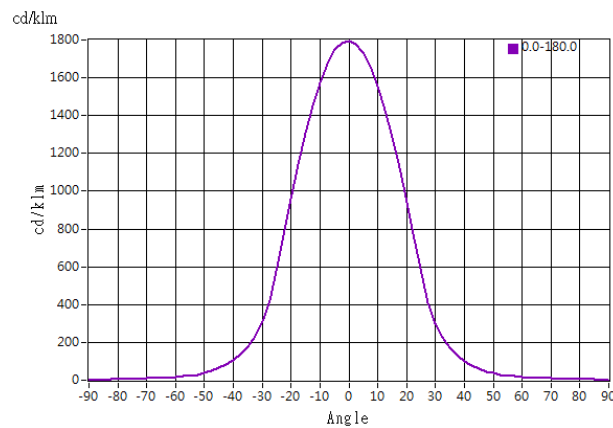

Illuminance At Distances

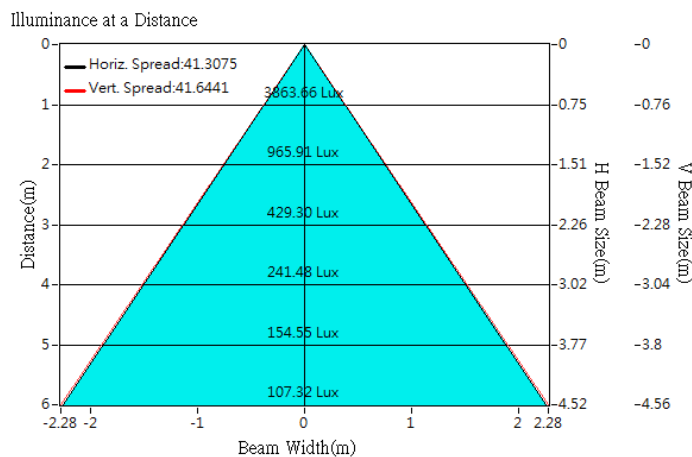



Optical Characteristics

Model Number	CKO-CH15-085040-5007	<p>"H" definition</p>
LED	Fortimo SLM 1205 L15 G7N	
LES / LED Size	Φ 14.5 mm	
FWHM (D50)	41°	
Field Angle (D10)	71°	
H (distance)	3.65mm	
Dimension	Φ =85 mm, Thickness=39.7 mm	
Luminous Flux	2075 lm	
Material	PC / UL94V2	

cd/klm

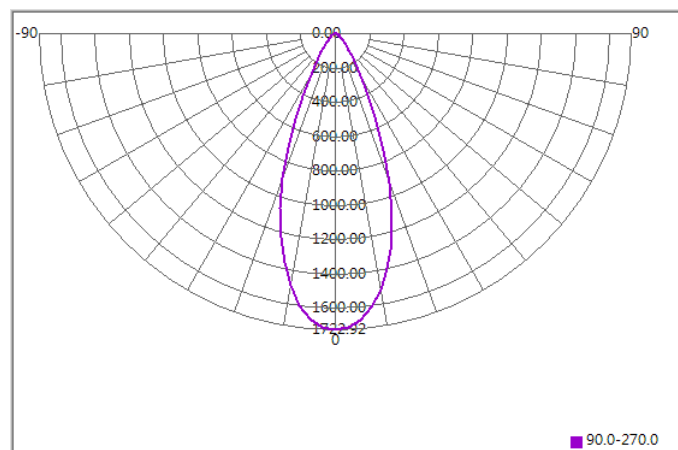

Illuminance At Distances

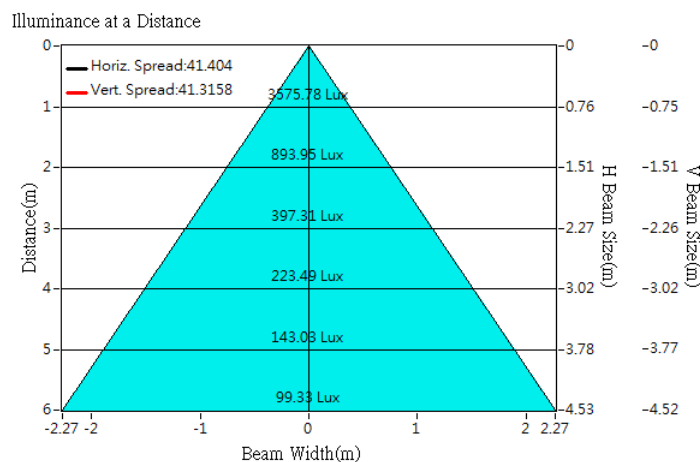



Optical Characteristics

Model Number	CKO-CH15-085040-5007	<p>"H" definition</p>
LED	Fortimo SLM 1206 L15 G7N	
LES / LED Size	Φ 14.5 mm	
FWHM (D50)	42°	
Field Angle (D10)	72°	
H (distance)	3.65mm	
Dimension	Φ =85 mm, Thickness=39.7 mm	
Luminous Flux	2524 lm	
Material	PC / UL94V2	

cd/klm

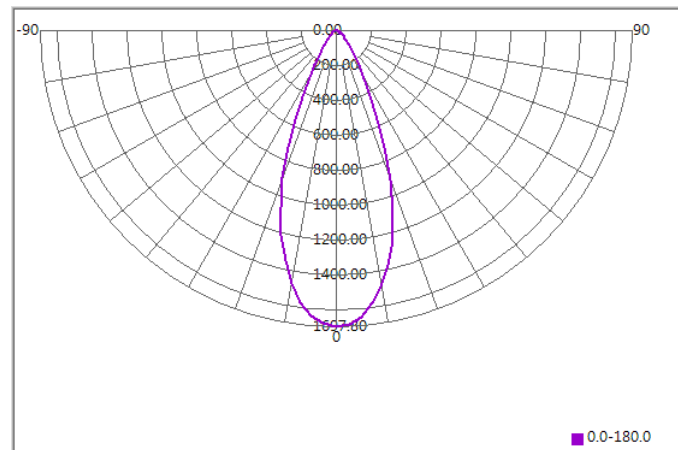

Illuminance At Distances

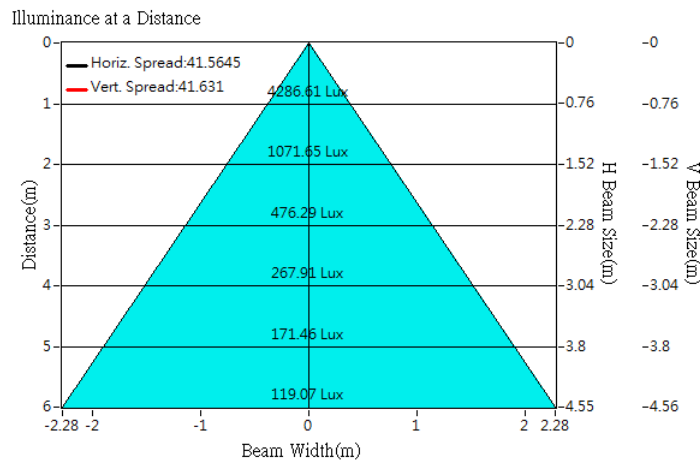



Optical Characteristics

Model Number	CKO-CH15-085040-5007	<p>"H" definition</p>
LED	Fortimo SLM 1208 L15 G7N	
LES / LED Size	Φ 14.5 mm	
FWHM (D50)	42°	
Field Angle (D10)	72°	
H (distance)	3.65mm	
Dimension	Φ =85 mm, Thickness=39.7 mm	
Luminous Flux	3526 lm	
Material	PC / UL94V2	

cd/klm

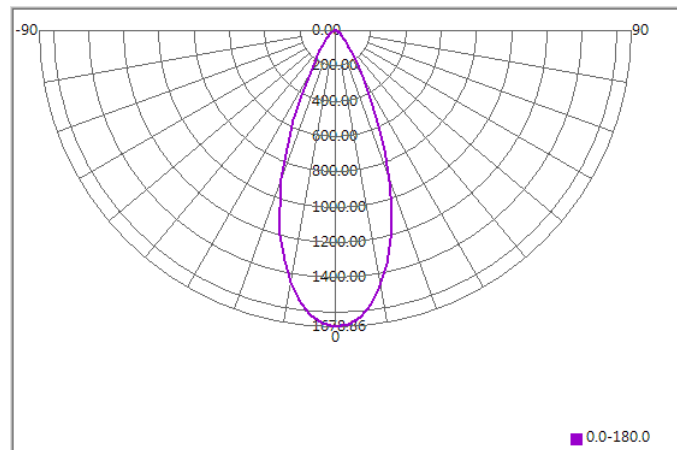

Illuminance At Distances

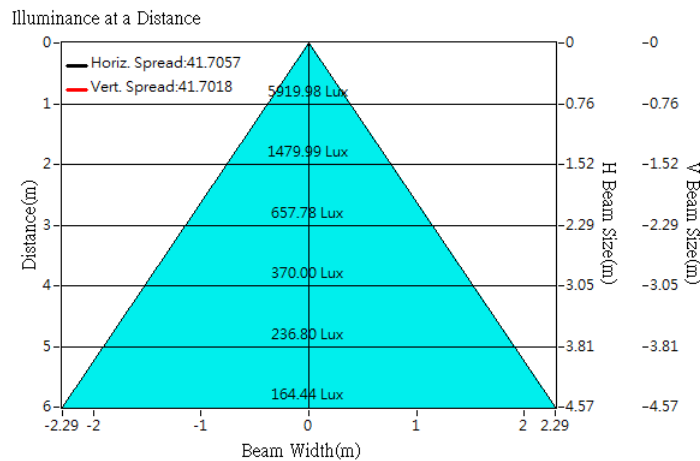

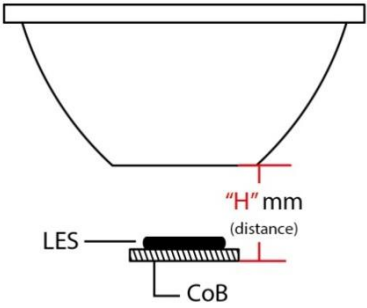

Optical Characteristics

Model Number	CKO-CH15-085040-5007	<p>"H" definition</p> 
LED	Fortimo SLM 1210 L15 G7N	
LES / LED Size	Φ 14.5 mm	
FWHM (D50)	42°	
Field Angle (D10)	72°	
H (distance)	3.65mm	
Dimension	Φ =85 mm, Thickness=39.7 mm	
Luminous Flux	4047 lm	
Material	PC / UL94V2	

cd/klm

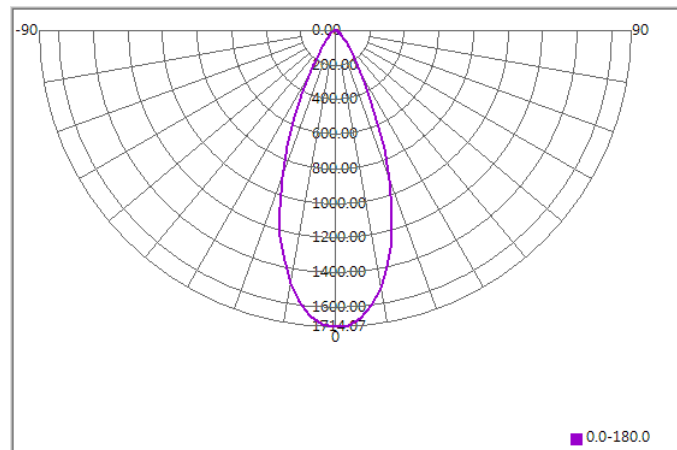

Illuminance At Distances

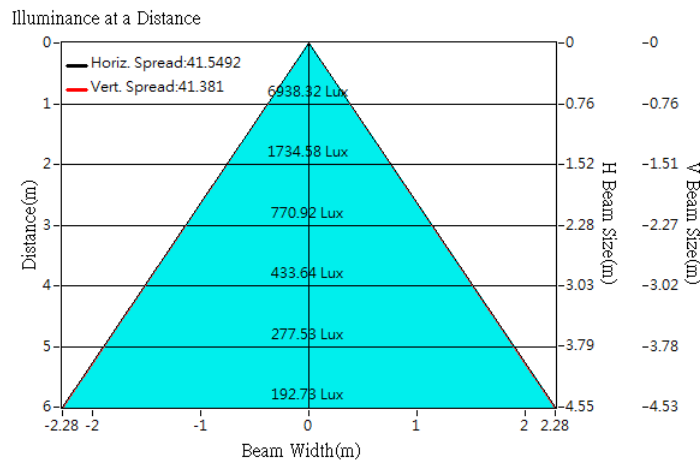



Optical Characteristics

Model Number	CKO-CH15-085040-5007		<p>"H" definition</p> <p>LES CoB "H" mm (distance)</p>
LED	Fortimo SLM 1208 L15 G7		
LES / LED Size	Φ 15 mm		
FWHM (D50)	42°		
Field Angle (D10)	72°		
H (distance)	3.65mm		
Dimension	Φ =85 mm, Thickness=39.7 mm		
Luminous Flux	2770 lm	Measured @ 26.2 W	
Material	PC / UL94V2		

cd/klm

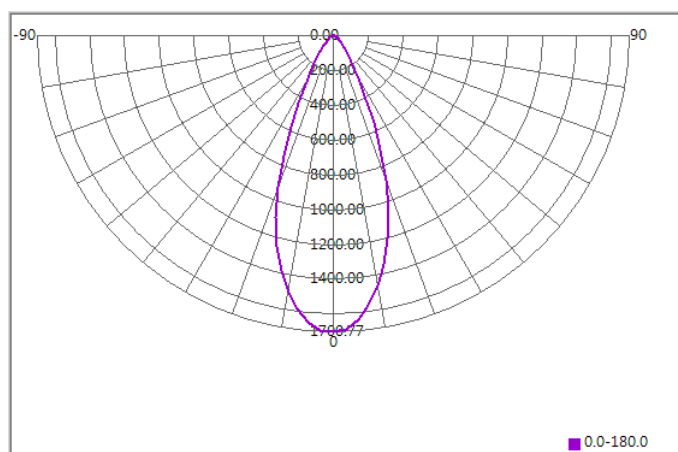

Illuminance At Distances

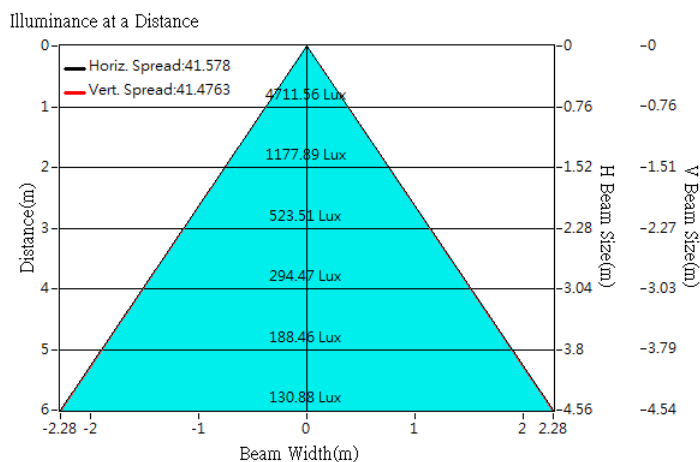



Optical Characteristics

Model Number	CKO-CH15-085040-5007	<p>"H" definition</p> <p>LES CoB "H" mm (distance)</p>
LED	Fortimo SLM 1208 L15 G6	
LES / LED Size	Φ 15 mm	
FWHM (D50)	41°	
Field Angle (D10)	71°	
H (distance)	3.65mm	
Dimension	Φ =85 mm, Thickness=39.7 mm	
Luminous Flux	2419 lm	
Material	PC / UL94V2	

cd/klm

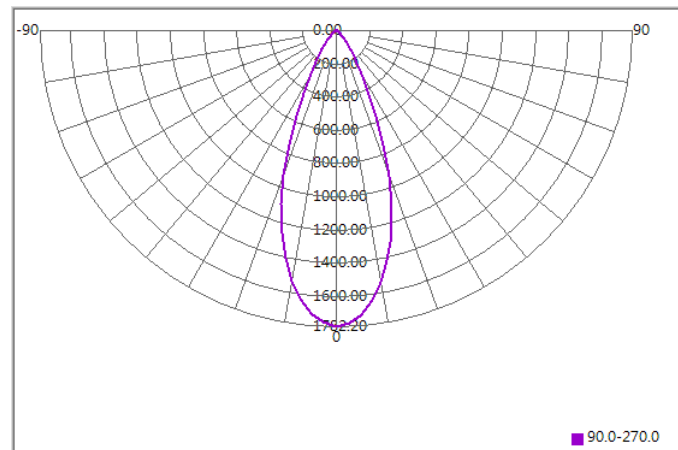

Illuminance At Distances

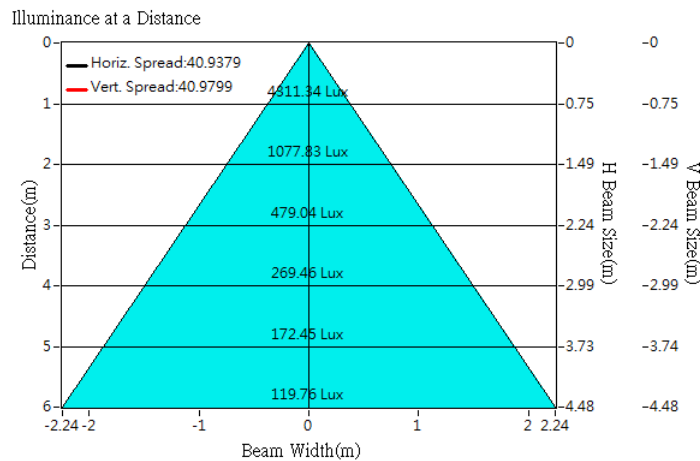



Optical Characteristics

Model Number	CKO-CH15-085040-5007		<p>"H" definition</p> <p>LES</p> <p>CoB</p>
LED	Fortimo SLM C 1208 L15 2024 G6_DL		
LES / LED Size	Φ 15 mm		
FWHM (D50)	42°		
Field Angle (D10)	72°		
H (distance)	3.5mm		
Dimension	Φ =85 mm, Thickness=39.7 mm		
Luminous Flux	2519 lm	Measured @ 26.8 W	
Material	PC / UL94V2		

cd/klm

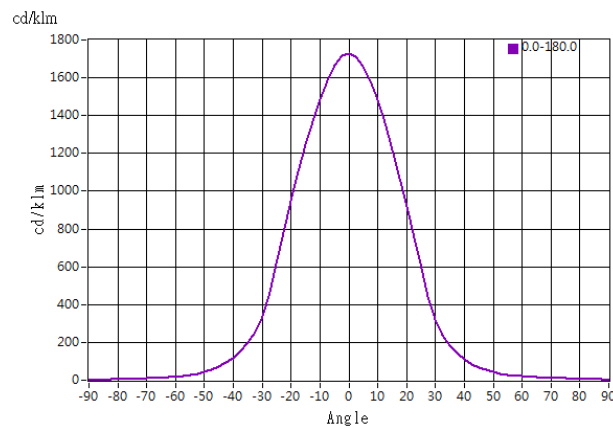

Illuminance At Distances

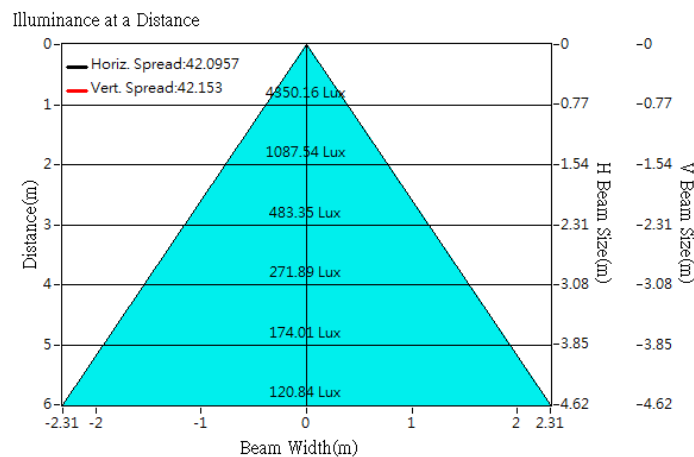



Optical Characteristics

Model Number	CKO-CH15-085040-5007		<p>"H" definition</p> <p>LES</p> <p>CoB</p>
LED	Fortimo SLM C 1208 L15 2024 G6_PI		
LES / LED Size	Φ 15 mm		
FWHM (D50)	42°		
Field Angle (D10)	72°		
H (distance)	3.5mm		
Dimension	Φ =85 mm, Thickness=39.7 mm		
Luminous Flux	2519 lm	Measured @ 26.8 W	
Material	PC / UL94V2		

cd/klm

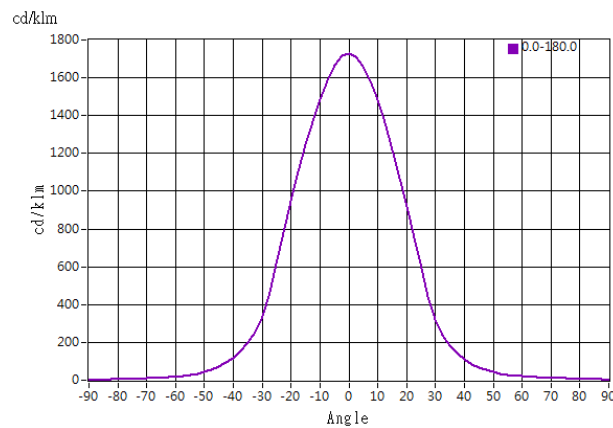

Illuminance At Distances

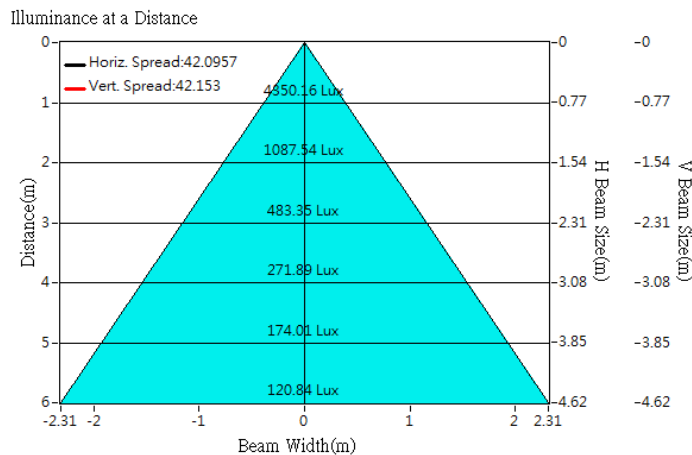



Optical Characteristics

Model Number	CKO-CH15-085040-5007		<p>"H" definition</p>
LED	Fortimo SLM C 1211 L19 2828 G6_DL		
LES / LED Size	Φ 19 mm		
FWHM (D50)	44°		
Field Angle (D10)	77°		
H (distance)	3.5mm		
Dimension	Φ =85 mm, Thickness=39.7 mm		
Luminous Flux	2676 lm	Measured @ 35.7 W	
Material	PC / UL94V2		

cd/klm

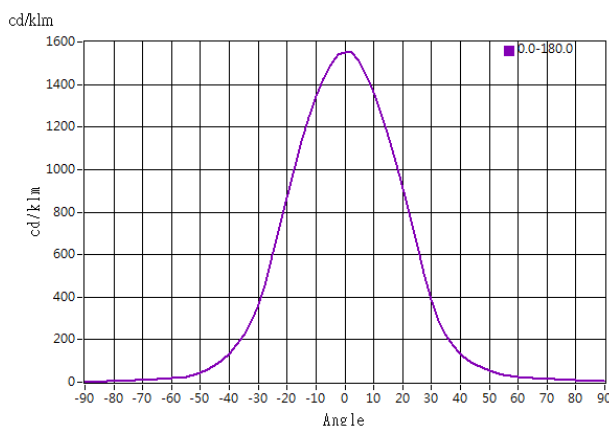

Illuminance At Distances

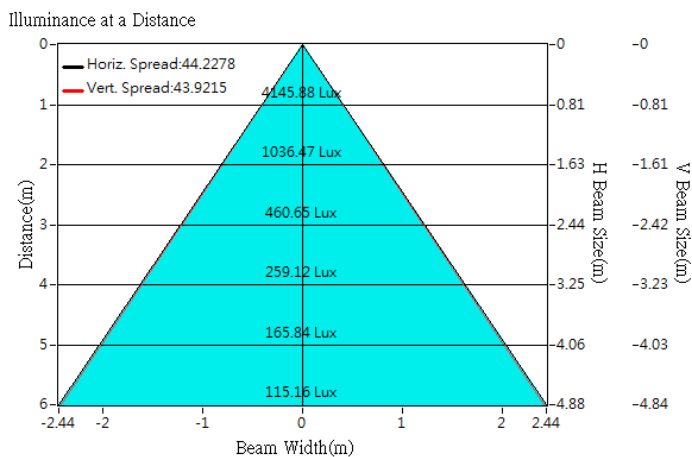



Optical Characteristics

Model Number	CKO-CH15-085040-5007		
LED	Fortimo SLM C 1211 L19 2828 G6_PI		
LES / LED Size	Φ 19 mm		
FWHM (D50)	44°		
Field Angle (D10)	77°		
H (distance)	3.5mm		
Dimension	Φ =85 mm, Thickness=39.7 mm		
Luminous Flux	2676 lm	Measured @ 35.7 W	
Material	PC / UL94V2		

cd/klm

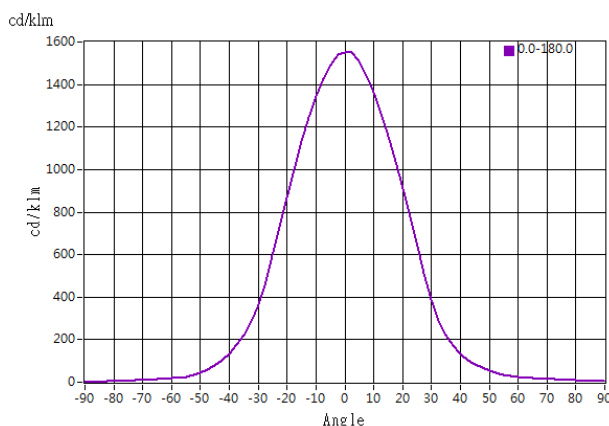

Illuminance At Distances

