



Product Model Number

CKO-CH15-092043-2401

✓ Model Number Definitions

CKO-XXXX-XXXXXX-XXXX



- A. Chun Kuang Optics Corp. Product
- B. Product Type: product abbreviation
Ex:
CH→CoB High Intensity
CC→CoB Compact
CS→Soft Shading for CoB LED
HC→Holder for CoB LED

- C. Identity Code
- D. Lens / Fixture Size
Ex: 075026=Φ75mm / Thickness=26mm (round up)
- C. Serial Numbers

The lens datasheet is applicable for **Philips LED**, that manufactured by Chun Kuang Optics Corp.

✓ Dimensions (mm) : Φ92 x 43

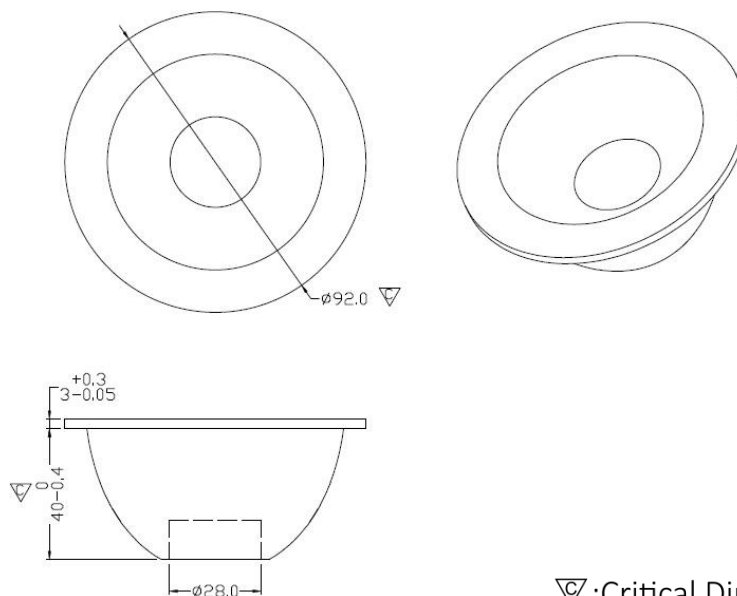

▽:Critical Dimension



Optical Characteristics

Model Number	CKO-CH15-092043-2401		<p>"H" definition</p>
LED	Fortimo SLM 830 1205 L13 G7		
LES / LED Size	Φ 13 mm		
FWHM (D50)	34°		
Field Angle (D10)	62°		
H (distance)	3.65 mm		
Dimension	Φ =92 mm, Thickness=43 mm		
Luminous Flux	1840 lm	Measured @ 17.6 W	
Material	PC / UL94V2		

cd/klm

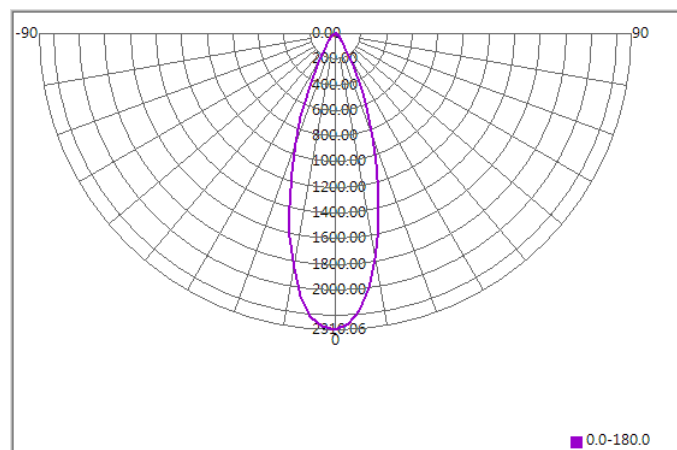

Illuminance At Distances

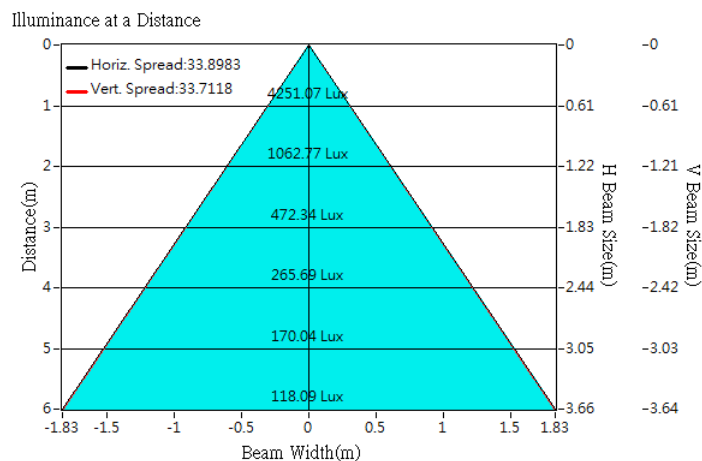



Optical Characteristics

Model Number	CKO-CH15-092043-2401		<p>"H" definition</p>
LED	Fortimo SLM PW 1205 L13 G6_DL		
LES / LED Size	Φ 13 mm		
FWHM (D50)	35°		
Field Angle (D10)	62°		
H (distance)	3.5 mm		
Dimension	Φ =92 mm, Thickness=43 mm		
Luminous Flux	2001 lm	Measured @ 17.6 W	
Material	PC / UL94V2		

cd/klm

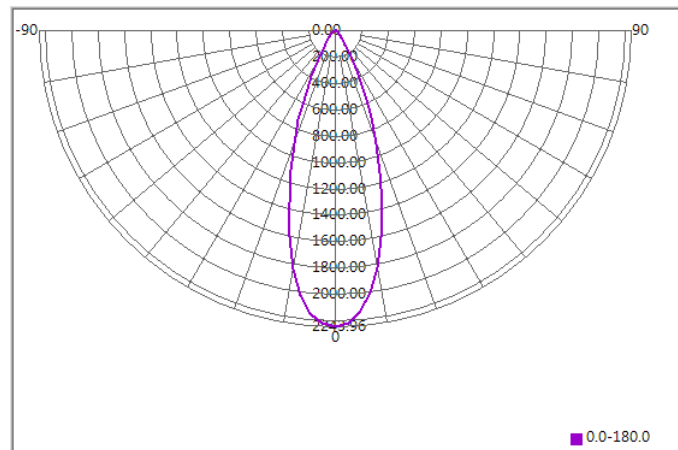

Illuminance At Distances

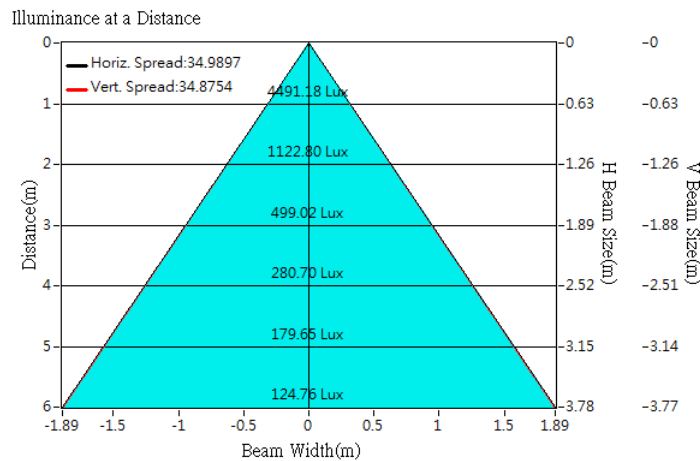



Optical Characteristics

Model Number	CKO-CH15-092043-2401		<p>"H" definition</p>
LED	Fortimo SLM PW 1205 L13 G6_PI		
LES / LED Size	Φ 13 mm		
FWHM (D50)	35°		
Field Angle (D10)	62°		
H (distance)	3.5 mm		
Dimension	Φ =92 mm, Thickness=43 mm		
Luminous Flux	2001 lm	Measured @ 17.6 W	
Material	PC / UL94V2		

cd/klm

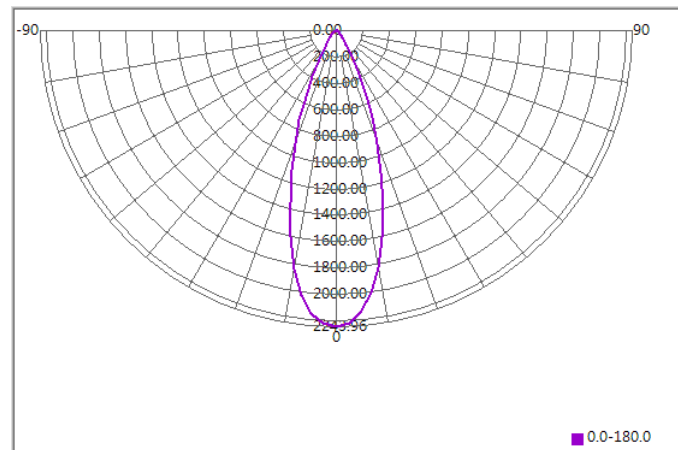

Illuminance At Distances

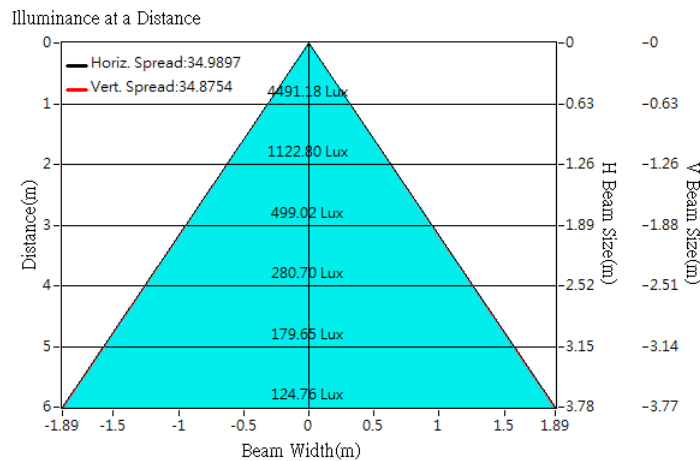

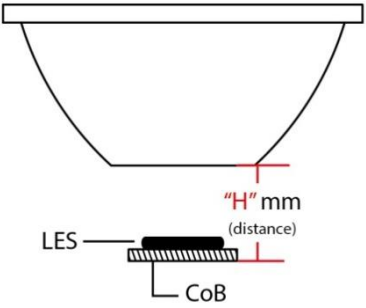

Optical Characteristics

Model Number	CKO-CH15-092043-2401		<p>"H" definition</p> 
LED	Fortimo SLM 1205 L15 G7N		
LES / LED Size	Φ 14.5 mm		
FWHM (D50)	34°		
Field Angle (D10)	62°		
H (distance)	3.65 mm		
Dimension	Φ =92 mm, Thickness=43 mm		
Luminous Flux	2110 lm	Measured @ 15.4 W	
Material	PC / UL94V2		

cd/klm

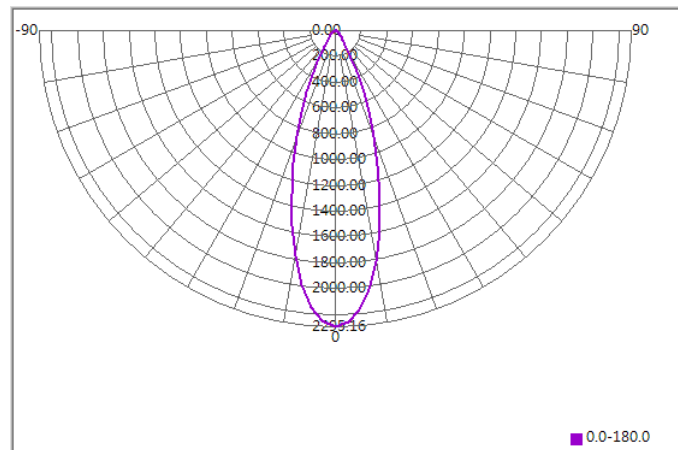

Illuminance At Distances

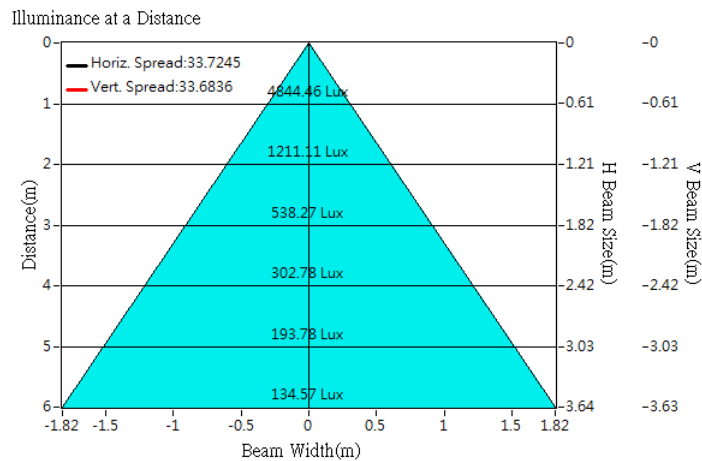



Optical Characteristics

Model Number	CKO-CH15-092043-2401		<p>"H" definition</p>
LED	Fortimo SLM 1206 L15 G7N		
LES / LED Size	Φ 14.5 mm		
FWHM (D50)	34°		
Field Angle (D10)	63°		
H (distance)	3.65 mm		
Dimension	Φ =92 mm, Thickness=43 mm		
Luminous Flux	2593 lm	Measured @ 18.5 W	
Material	PC / UL94V2		

cd/klm

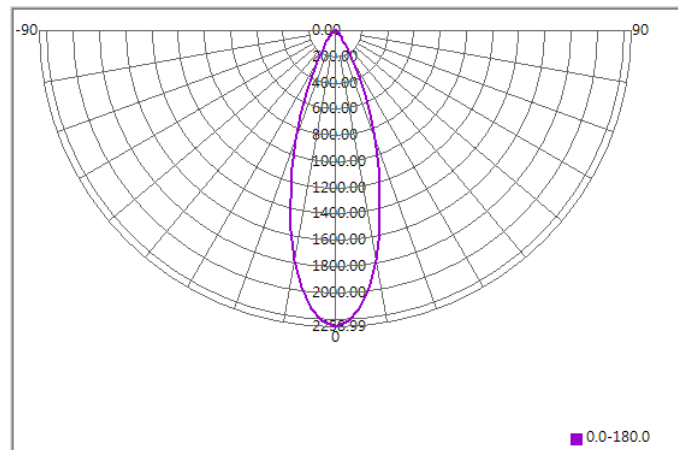

Illuminance At Distances

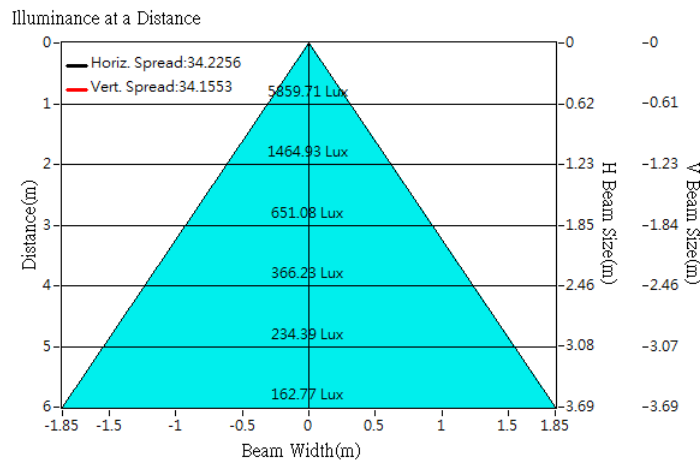



Optical Characteristics

Model Number	CKO-CH15-092043-2401		<p>"H" definition</p>
LED	Fortimo SLM 1208 L15 G7N		
LES / LED Size	Φ 14.5 mm		
FWHM (D50)	35°		
Field Angle (D10)	63°		
H (distance)	3.65 mm		
Dimension	Φ =92 mm, Thickness=43 mm		
Luminous Flux	3575 lm	Measured @ 25.0 W	
Material	PC / UL94V2		

cd/klm

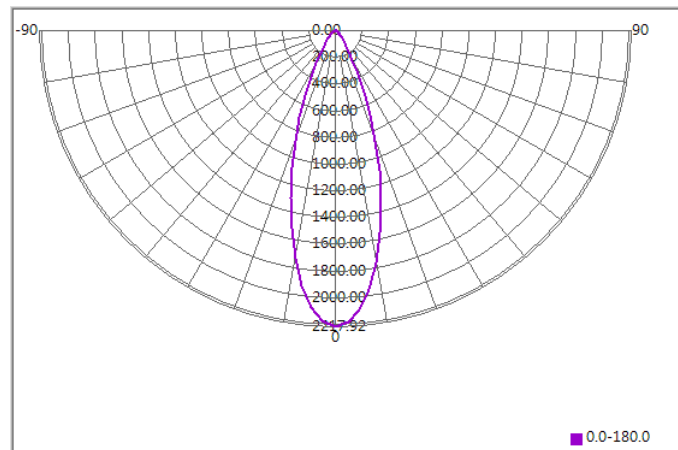

Illuminance At Distances

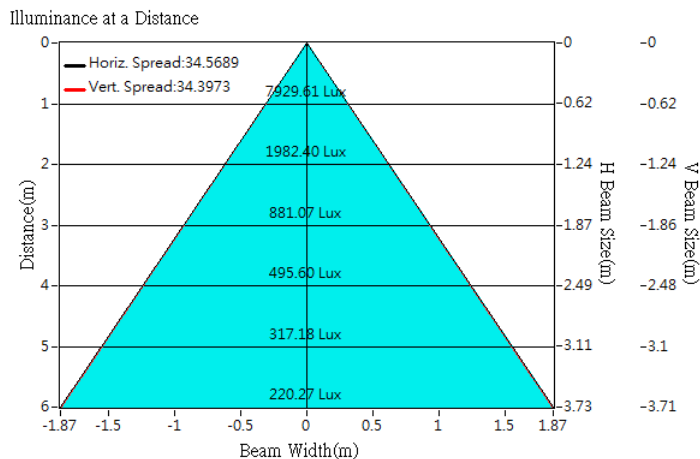



Optical Characteristics

Model Number	CKO-CH15-092043-2401		<p>"H" definition</p>
LED	Fortimo SLM 1208 L15 G7		
LES / LED Size	Φ 15 mm		
FWHM (D50)	35°		
Field Angle (D10)	63°		
H (distance)	3.65 mm		
Dimension	Φ =92 mm, Thickness=43 mm		
Luminous Flux	2841 lm	Measured @ 26.2 W	
Material	PC / UL94V2		

cd/klm

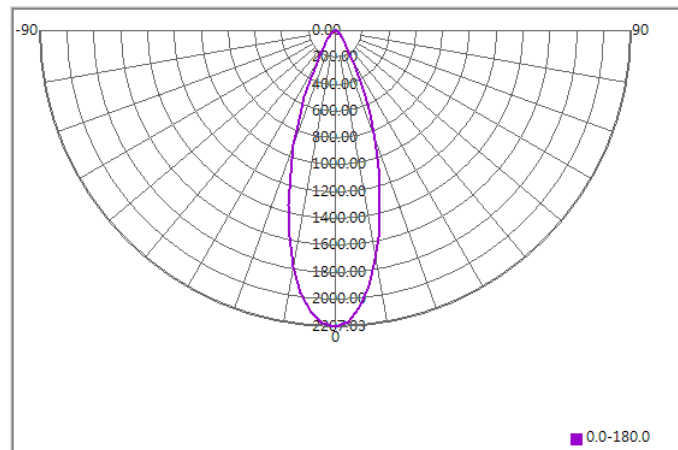

Illuminance At Distances

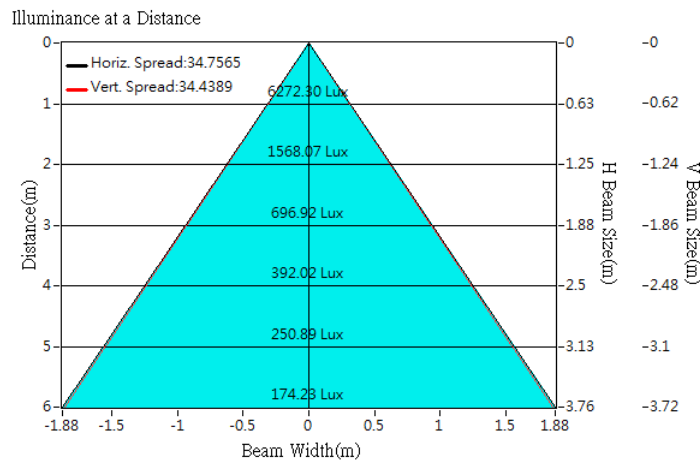



Optical Characteristics

Model Number	CKO-CH15-092043-2401		<p>"H" definition</p>
LED	Fortimo SLM 1208 L15 G6_DL		
LES / LED Size	Φ 15 mm		
FWHM (D50)	36°		
Field Angle (D10)	63°		
H (distance)	3.5 mm		
Dimension	Φ =92 mm, Thickness=43 mm		
Luminous Flux	1715 lm	Measured @ 17.2 W	
Material	PC / UL94V2		

cd/klm

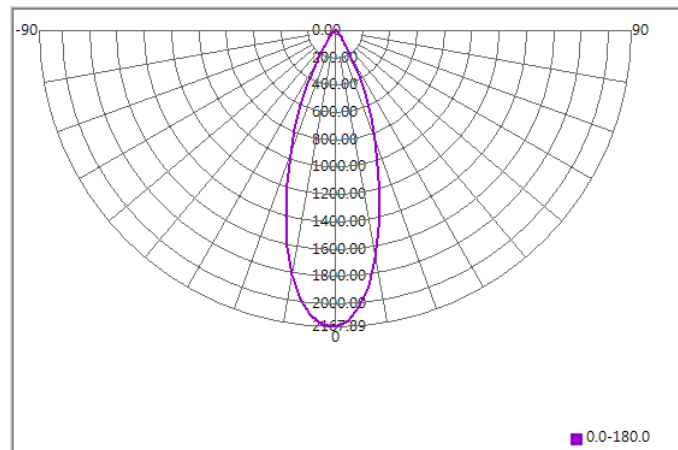

Illuminance At Distances

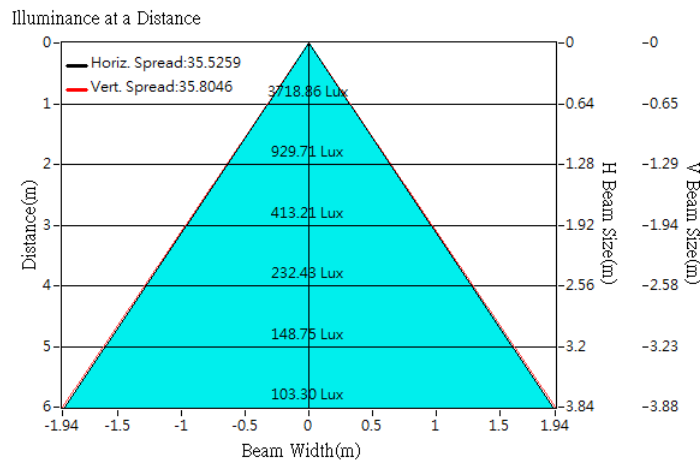



Optical Characteristics

Model Number	CKO-CH15-092043-2401		<p>"H" definition</p>
LED	Fortimo SLM 1208 L15 G6_PI		
LES / LED Size	Φ 15 mm		
FWHM (D50)	36°		
Field Angle (D10)	63°		
H (distance)	3.5 mm		
Dimension	Φ =92 mm, Thickness=43 mm		
Luminous Flux	1715 lm	Measured @ 17.2 W	
Material	PC / UL94V2		

cd/klm

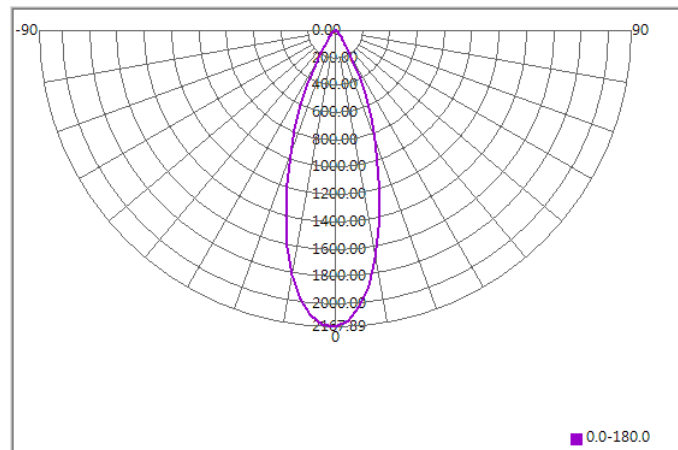

Illuminance At Distances

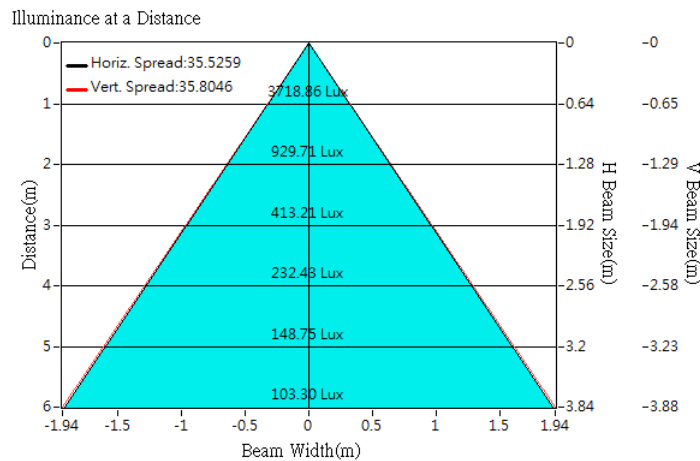



Optical Characteristics

Model Number	CKO-CH15-092043-2401		<p>"H" definition</p>
LED	Fortimo SLM 1211 L22 G7N		
LES / LED Size	Φ 22 mm		
FWHM (D50)	42°		
Field Angle (D10)	72°		
H (distance)	3.65 mm		
Dimension	Φ =92 mm, Thickness=43 mm		
Luminous Flux	4033 lm	Measured @ 34.1 W	
Material	PC / UL94V2		

cd/klm

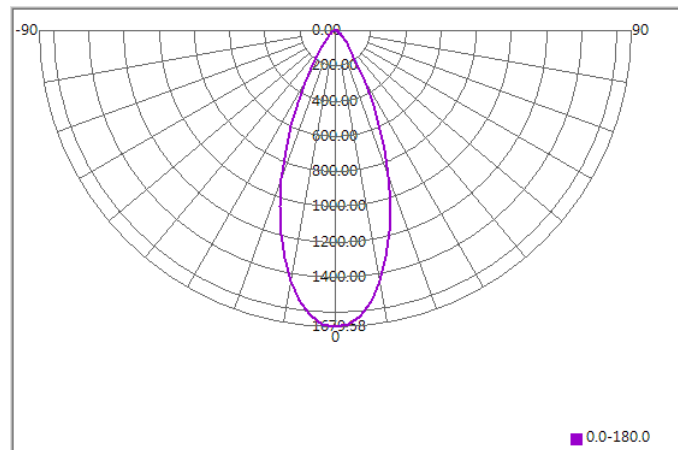

Illuminance At Distances

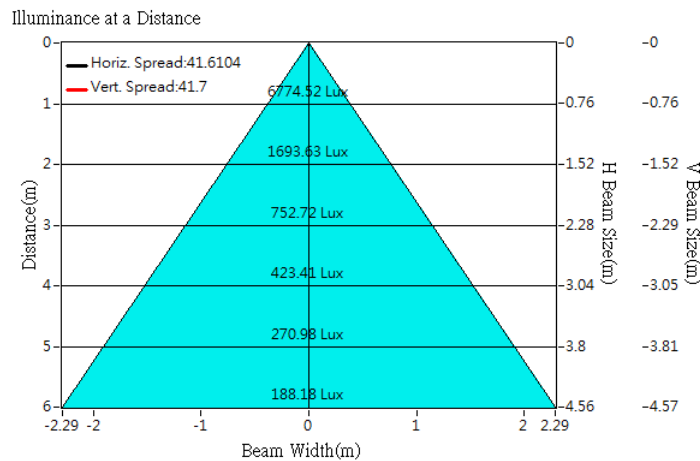



Lens Accessories - CoB Holder

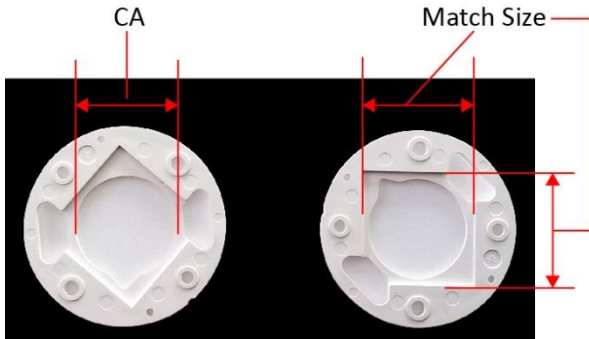

Example of LES Area & LED Size Dimension Locations

Product Model	Match Size (mm)	CA (mm)	Material	Applicability
CKO-HC14-161911-0501	16.3 x 19.3	Φ 11.9	PBT	Philips 1202
CKO-HC14-161911-0501	16.3 x 19.3	Φ 11.9	PBT	Philips 1203
CKO-HC14-202419-0502	20.3 x 24.3	Φ 19.2	PBT	Philips 1204
CKO-HC14-202419-0502	20.3 x 24.3	Φ 19.2	PBT	Philips 1205