



Product Model Number

CKO-CH15-110058-3601

✓ Model Number Definitions

CKO-XXXX-XXXXXX-XXXX



- A. Chun Kuang Optics Corp. Product
- B. Product Type: product abbreviation
Ex:
CH→CoB High Intensity
CC→CoB Compact
CS→Soft Shading for CoB LED
HC→Holder for CoB LED

- C. Identity Code
- D. Lens / Fixture Size
Ex: 075026=Φ75mm / Thickness=26mm (round up)
- C. Serial Numbers

The lens datasheet is applicable for **Citizen LED**, that manufactured by Chun Kuang Optics Corp.

✓ Dimensions (mm) : Φ110 x 58

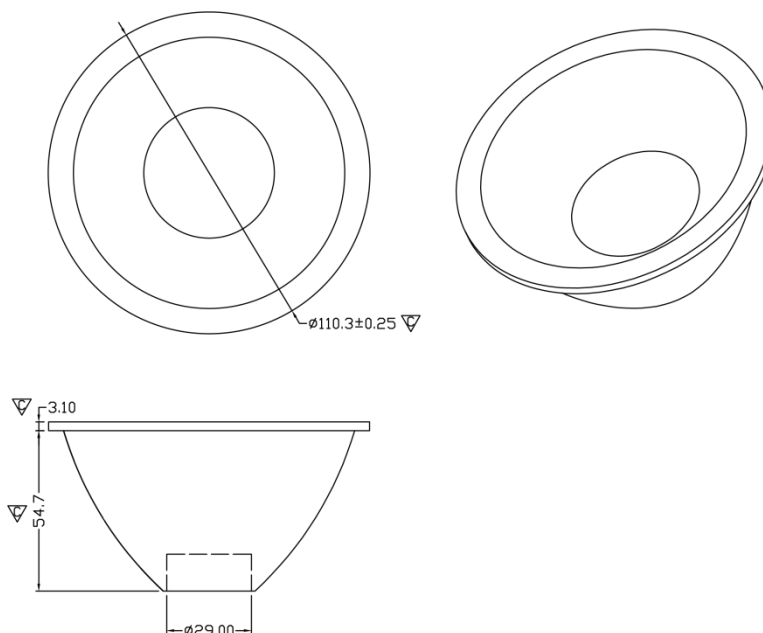

▽:Critical Dimension



Optical Characteristics

Model Number	CKO-CH15-110058-3601		<p>"H" definition</p>
LED	CLU 720		
LES / LED Size	Φ 11 mm		
FWHM (D50)	12°		
Field Angle (D10)	27°		
H (distance)	4 mm		
Dimension	Φ =110 mm, Thickness=58 mm		
Luminous Flux	3320 lm	Measured @39.1 W	
Material	PC / UL94V2		

cd/klm

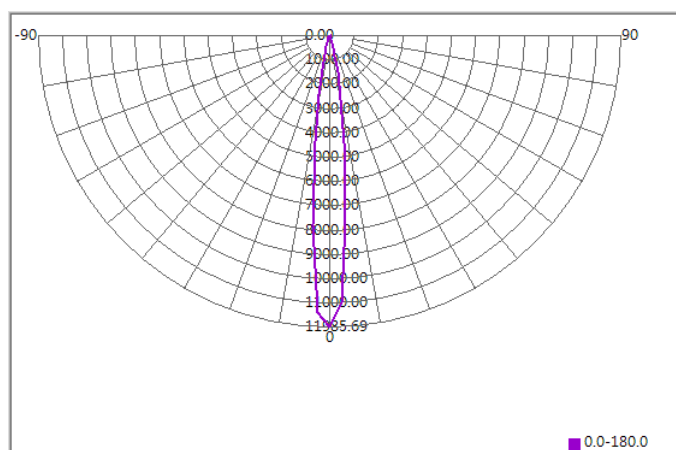

Illuminance At Distances

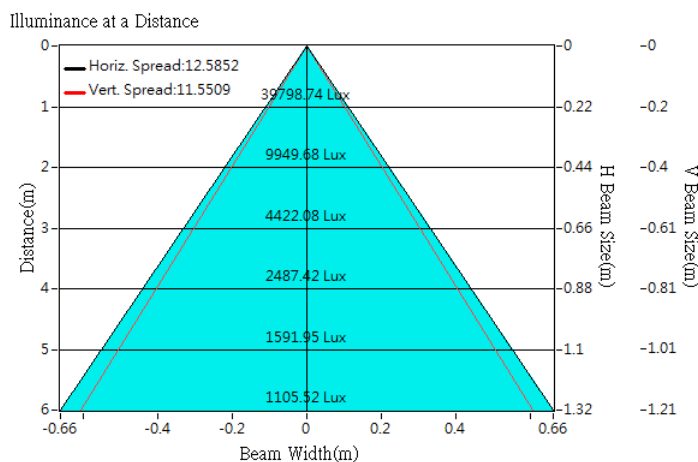



Optical Characteristics

Model Number	CKO-CH15-110058-3601	<p>"H" definition</p> <p>LES CoB</p>
LED	CLU 730	
LES / LED Size	Φ 13 mm	
FWHM (D50)	12°	
Field Angle (D10)	28°	
H (distance)	4 mm	
Dimension	Φ =110 mm, Thickness=58 mm	
Luminous Flux	4933 lm	
Material	PC / UL94V2	

cd/klm

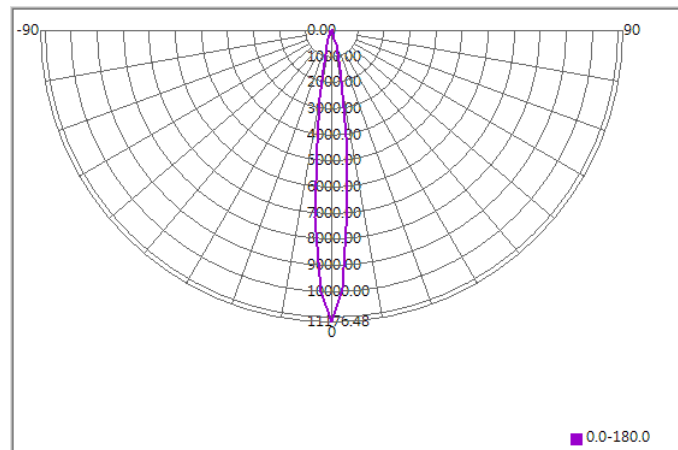

Illuminance At Distances

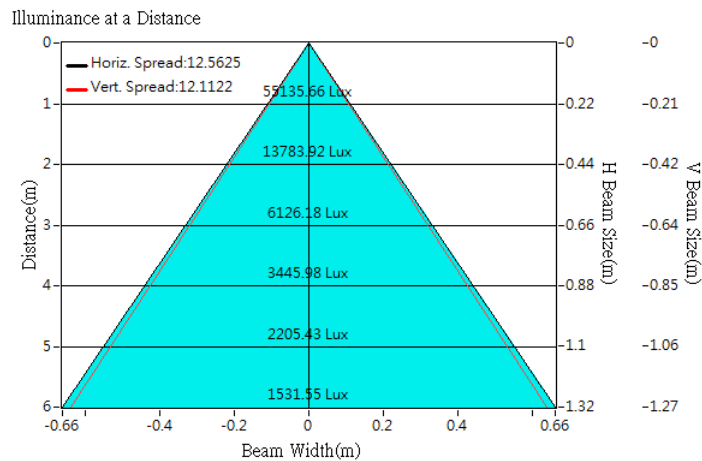



Optical Characteristics

Model Number	CKO-CH15-110058-3601		<p>"H" definition</p>
LED	CLU 038		
LES / LED Size	Φ 14.5 mm		
FWHM (D50)	13°		
Field Angle (D10)	31°		
H (distance)	4 mm		
Dimension	Φ =110 mm, Thickness=58 mm		
Luminous Flux	2831 lm	Measured @25 W	
Material	PC / UL94V2		

cd/klm

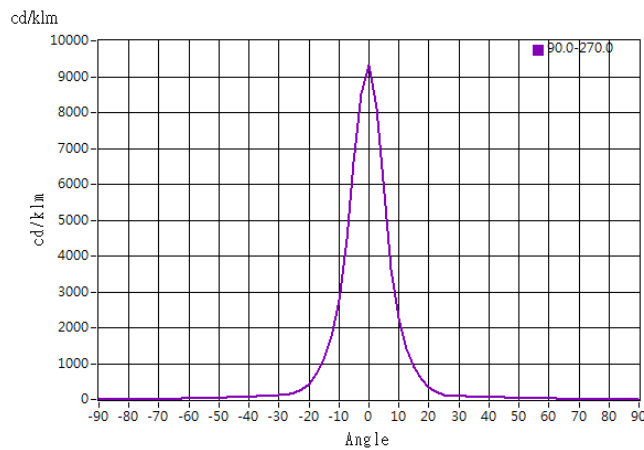

Illuminance At Distances

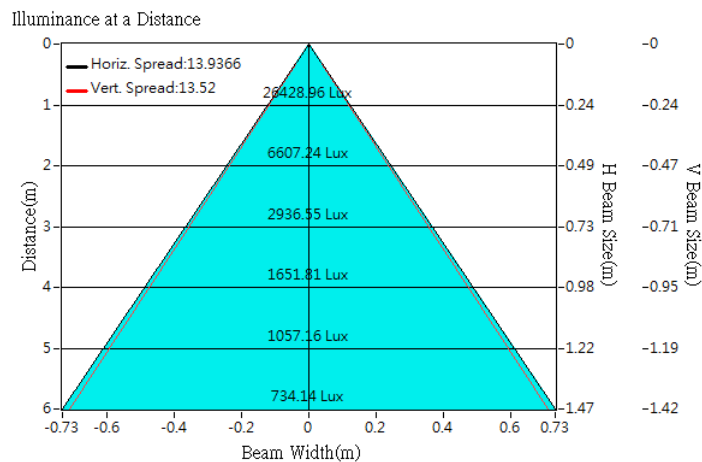



Optical Characteristics

Model Number	CKO-CH15-110058-3601		<p>"H" definition</p>
LED	CLU 036		
LES / LED Size	Φ 14.5 mm		
FWHM (D50)	13°		
Field Angle (D10)	32°		
H (distance)	4 mm		
Dimension	Φ =110 mm, Thickness=58 mm		
Luminous Flux	1856 lm	Measured @15 W	
Material	PC / UL94V2		

cd/klm

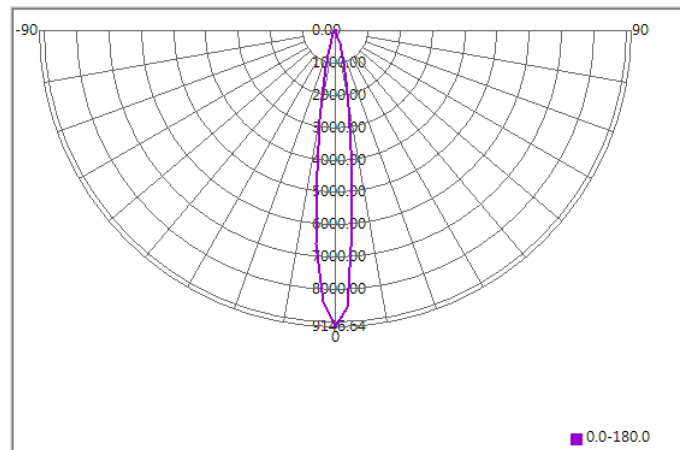

Illuminance At Distances

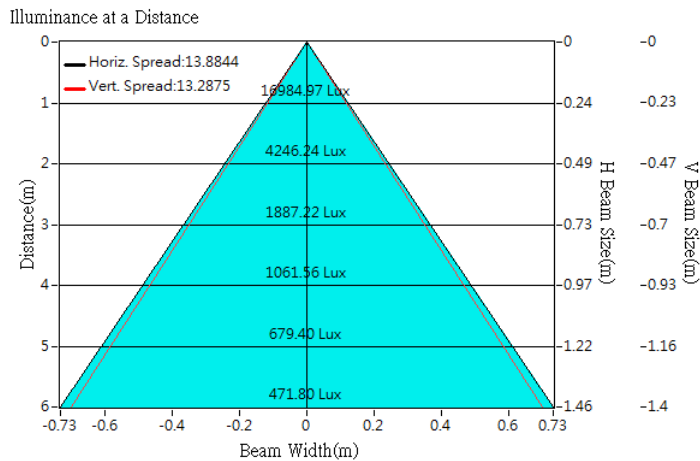



Optical Characteristics

Model Number	CKO-CH15-110058-3601		<p>"H" definition</p>
LED	CLU 046		
LES / LED Size	Φ 22 mm		
FWHM (D50)	19°		
Field Angle (D10)	44°		
H (distance)	4 mm		
Dimension	Φ =110 mm, Thickness=58 mm		
Luminous Flux	4885 lm	Measured @37.4 W	
Material	PC / UL94V2		

cd/klm

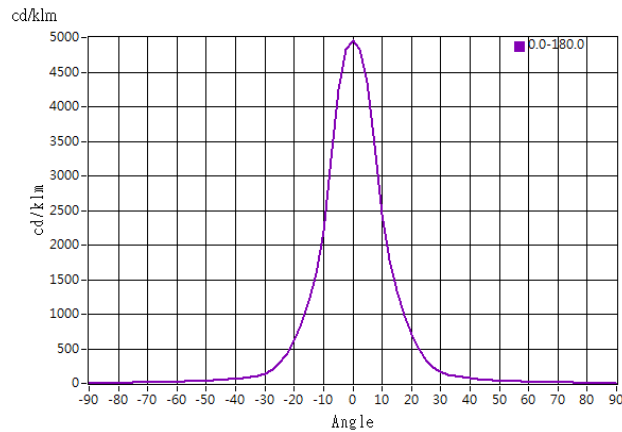

Illuminance At Distances

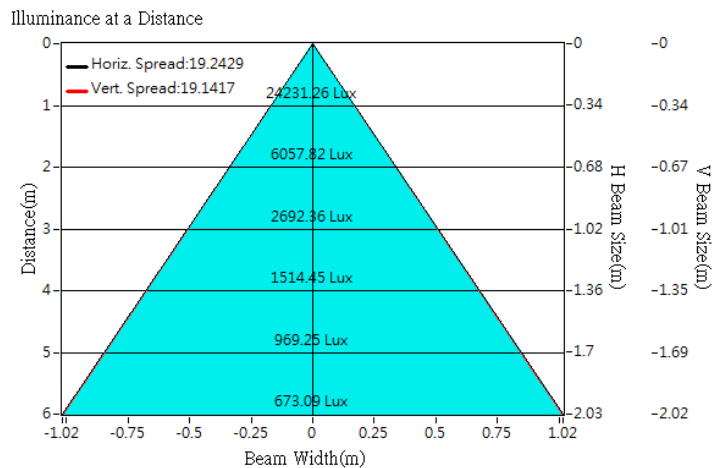



Lens Accessories - CoB Holder

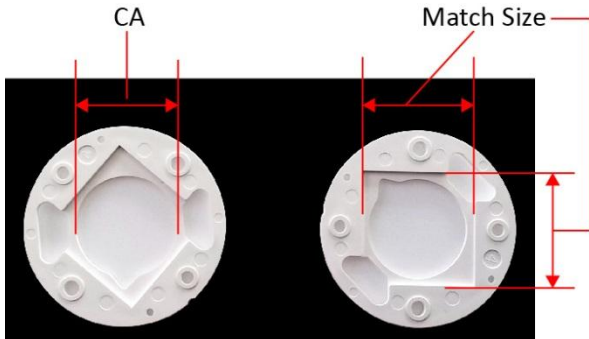

Example of LES Area & LED Size Dimension Locations

Product Model	Match Size (mm)	CA (mm)	Material	Applicability
CKO-HC13-131311-6416	13.8 x 13.8	Φ 11.6	PBT	Citizen CLL020
CKO-HC13-191917-6417	19.3 x 19.3	Φ 17.4	PBT	Citizen CLL030
CKO-HC13-282824-6418	28.3 x 28.3	Φ 24.9	PBT	Citizen CLL040