



Product Model Number

CKO-CH15-110058-3701

✓ Model Number Definitions

CKO-XXXX-XXXXXX-XXXX



- A. Chun Kuang Optics Corp. Product
- B. Product Type: product abbreviation
Ex:
CH→CoB High Intensity
CC→CoB Compact
CS→Soft Shading for CoB LED
HC→Holder for CoB LED

- C. Identity Code
- D. Lens / Fixture Size
Ex: 075026=Φ75mm / Thickness=26mm (round up)
- C. Serial Numbers

The lens datasheet is applicable for **Philips LED**, that manufactured by Chun Kuang Optics Corp.

✓ Dimensions (mm) : Φ110 x 57.8

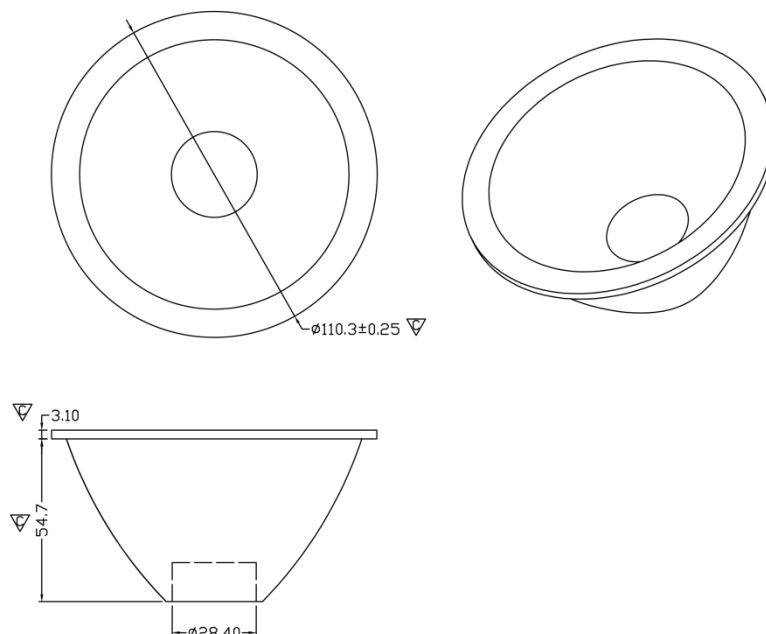

▽:Critical Dimension



Optical Characteristics

Model Number	CKO-CH15-110058-3701		
LED	Fortimo SLM 1205 L13 G7		
LES / LED Size	Φ 13 mm		
FWHM (D50)	17°		
Field Angle (D10)	34°		
H (distance)	4 mm		
Dimension	Φ =110 mm, Thickness=57.8 mm		
Luminous Flux	2246 lm	Measured @ 17.7 W	
Material	PC / UL94V2		

cd/klm

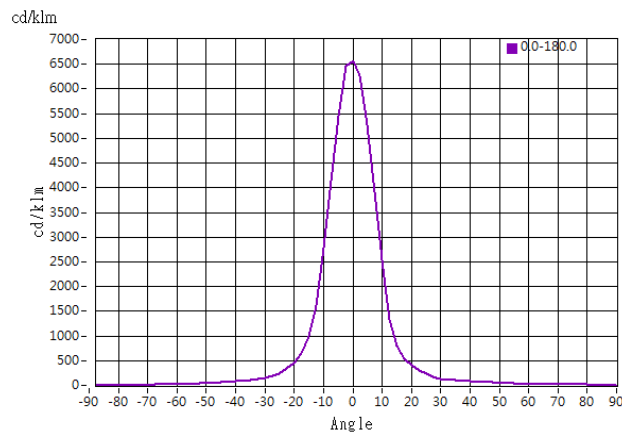

Illuminance At Distances

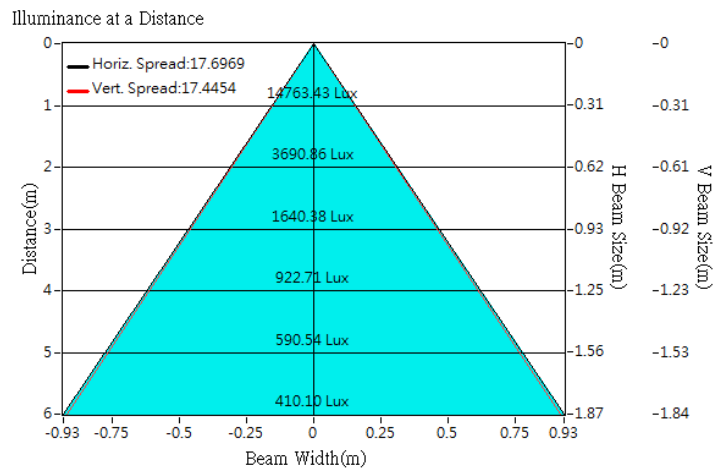



Optical Characteristics

Model Number	CKO-CH15-110058-3701		<p>"H" definition</p>
LED	Fortimo SLM 1205 L13 G6		
LES / LED Size	Φ 13 mm		
FWHM (D50)	17°		
Field Angle (D10)	33°		
H (distance)	4 mm		
Dimension	Φ =110 mm, Thickness=57.8 mm		
Luminous Flux	2129 lm	Measured @ 17.8 W	
Material	PC / UL94V2		

cd/klm

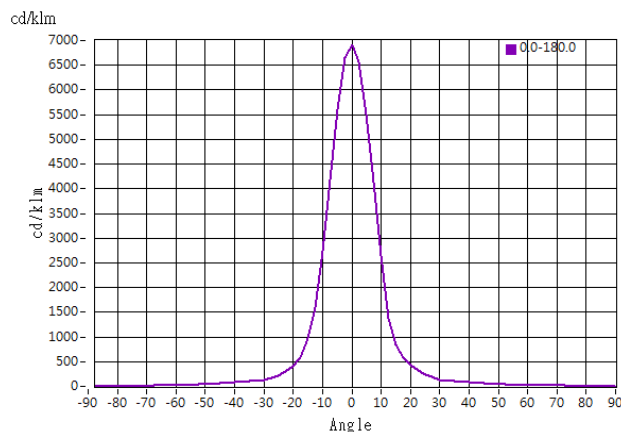

Illuminance At Distances

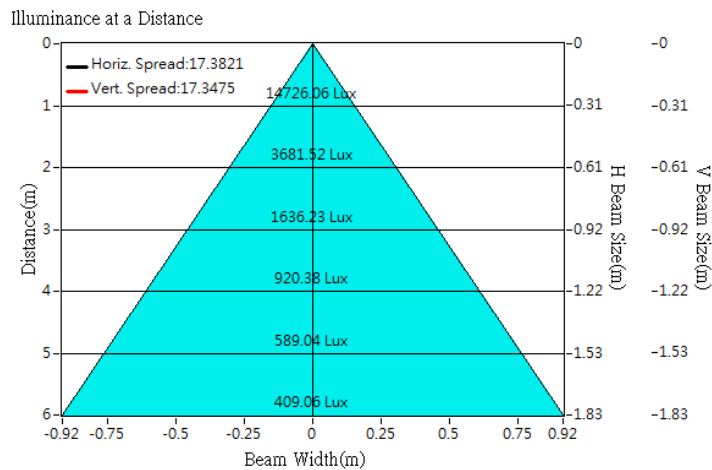



Optical Characteristics

Model Number	CKO-CH15-110058-3701		
LED	Fortimo SLM C 1205 L13 2024 G6_PI		
LES / LED Size	Φ 13 mm		
FWHM (D50)	17°		
Field Angle (D10)	34°		
H (distance)	3.5 mm		
Dimension	Φ =110 mm, Thickness=57.8 mm		
Luminous Flux	2124 lm	Measured @ 17.7 W	
Material	PC / UL94V2		

cd/klm

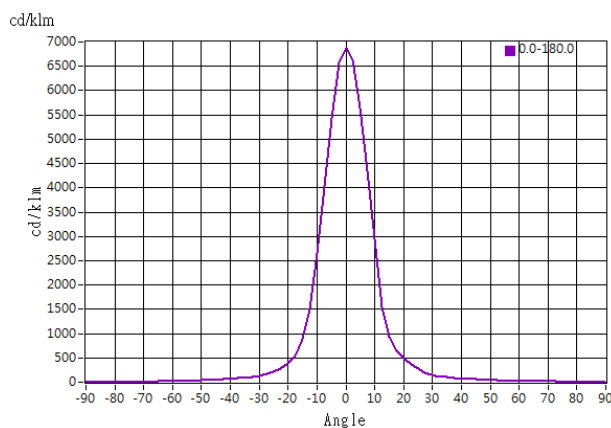

Illuminance At Distances

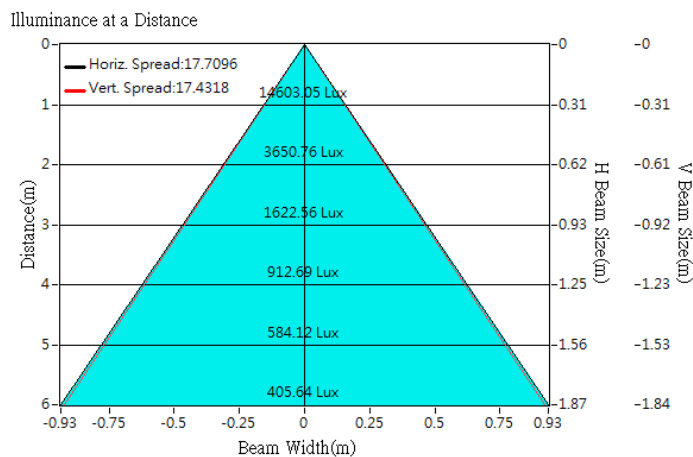



Optical Characteristics

Model Number	CKO-CH15-110058-3701		<p>"H" definition</p>
LED	Fortimo SLM 1205 L15 G7N		
LES / LED Size	Φ 14.5 mm		
FWHM (D50)	17°		
Field Angle (D10)	40°		
H (distance)	4 mm		
Dimension	Φ =110 mm, Thickness=57.8 mm		
Luminous Flux	2026 lm	Measured @ 15.4 W	
Material	PC / UL94V2		

cd/klm

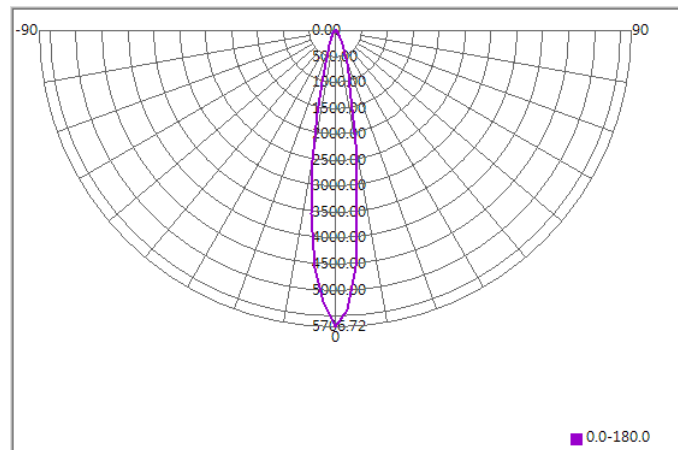

Illuminance At Distances

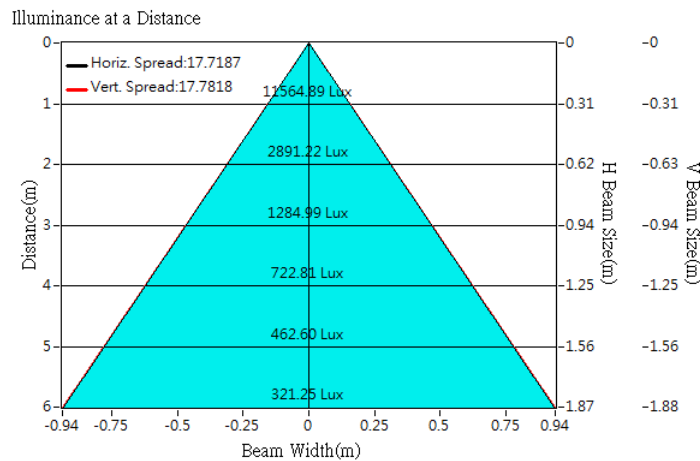

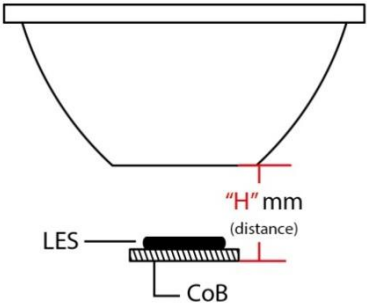

Optical Characteristics

Model Number	CKO-CH15-110058-3701		<p>"H" definition</p> 
LED	Fortimo SLM 1206 L15 G7N		
LES / LED Size	Φ 14.5 mm		
FWHM (D50)	17°		
Field Angle (D10)	36°		
H (distance)	4 mm		
Dimension	Φ =110 mm, Thickness=57.8 mm		
Luminous Flux	2542 lm	Measured @ 18.5 W	
Material	PC / UL94V2		

cd/klm

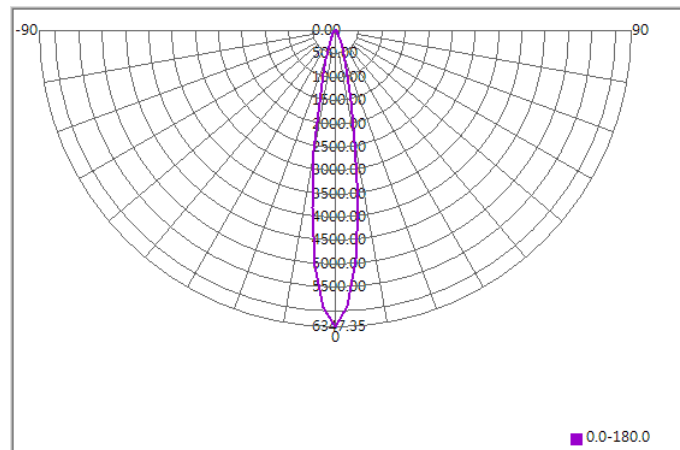

Illuminance At Distances

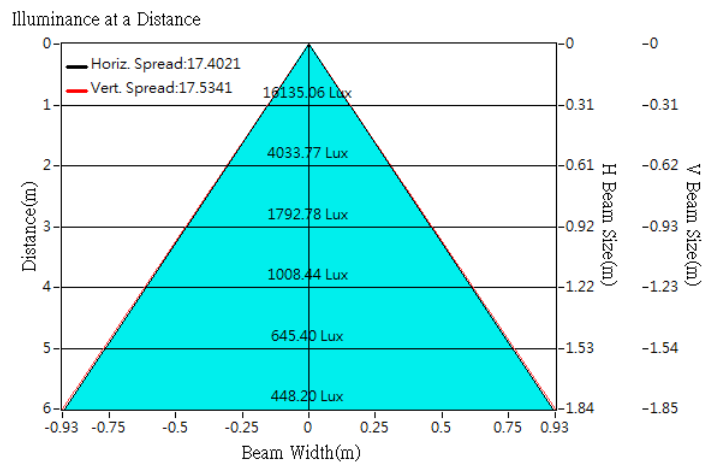



Optical Characteristics

Model Number	CKO-CH15-110058-3701		<p>"H" definition</p>
LED	Fortimo SLM 1208 L15 G7N		
LES / LED Size	Φ 14.5 mm		
FWHM (D50)	17°		
Field Angle (D10)	36°		
H (distance)	4 mm		
Dimension	Φ =110 mm, Thickness=57.8 mm		
Luminous Flux	3495 lm	Measured @ 25.0 W	
Material	PC / UL94V2		

cd/klm

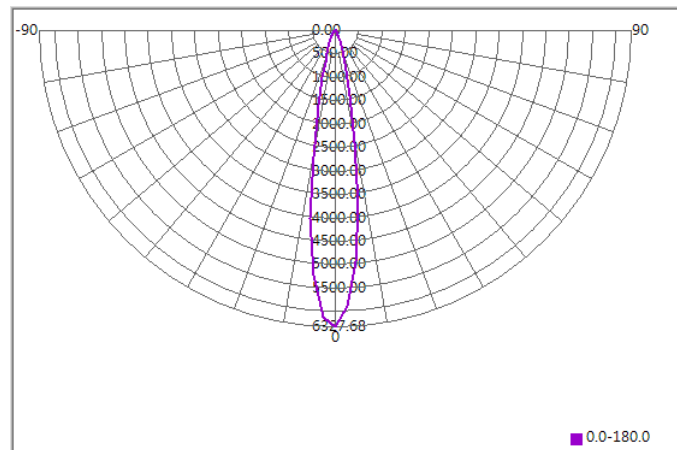

Illuminance At Distances

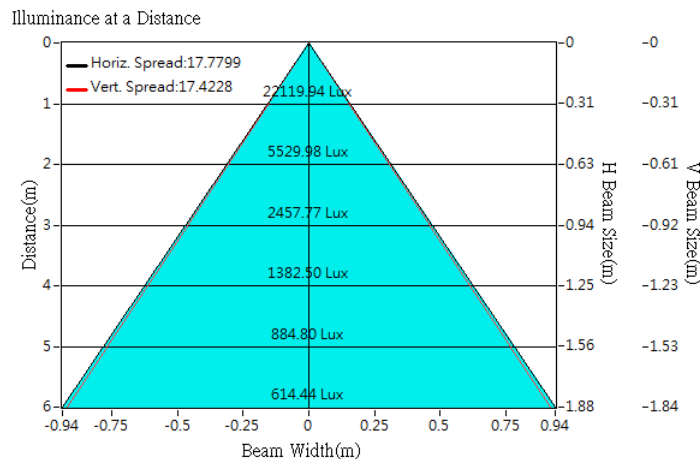



Optical Characteristics

Model Number	CKO-CH15-110058-3701		<p>"H" definition</p>
LED	Fortimo SLM 1208 L15 G7		
LES / LED Size	Φ 15 mm		
FWHM (D50)	17°		
Field Angle (D10)	36°		
H (distance)	4 mm		
Dimension	Φ =110 mm, Thickness=57.8 mm		
Luminous Flux	2891 lm	Measured @ 26.3 W	
Material	PC / UL94V2		

cd/klm

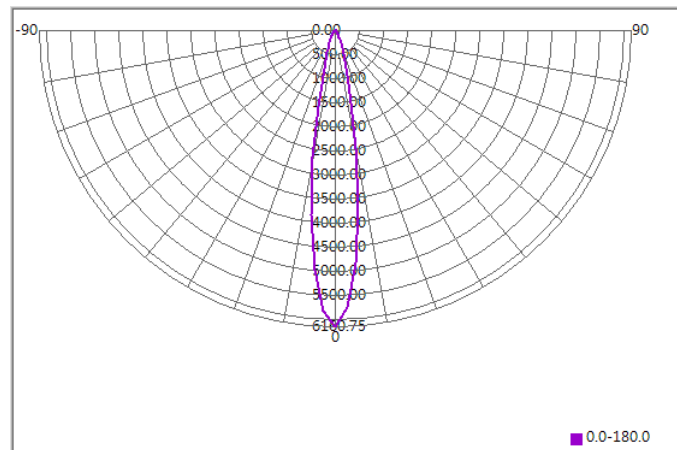

Illuminance At Distances

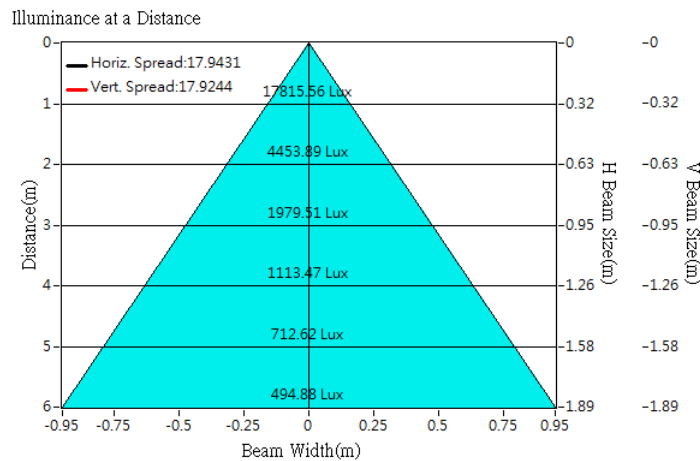



Optical Characteristics

Model Number	CKO-CH15-110058-3701		<p>"H" definition</p>
LED	Fortimo SLM 1208 L15 G6		
LES / LED Size	Φ 15 mm		
FWHM (D50)	18°		
Field Angle (D10)	36°		
H (distance)	4 mm		
Dimension	Φ =110 mm, Thickness=57.8 mm		
Luminous Flux	2528 lm	Measured @ 26.8 W	
Material	PC / UL94V2		

cd/klm

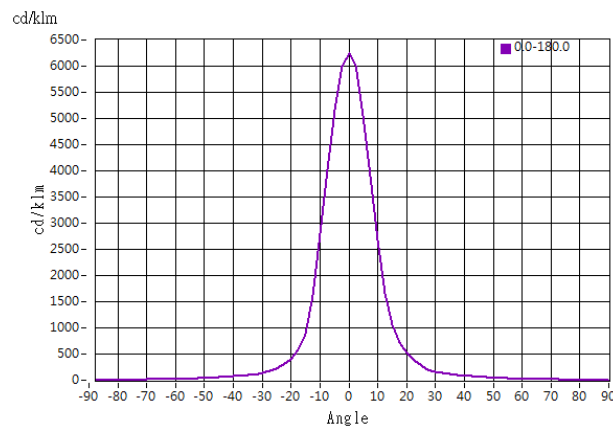

Illuminance At Distances

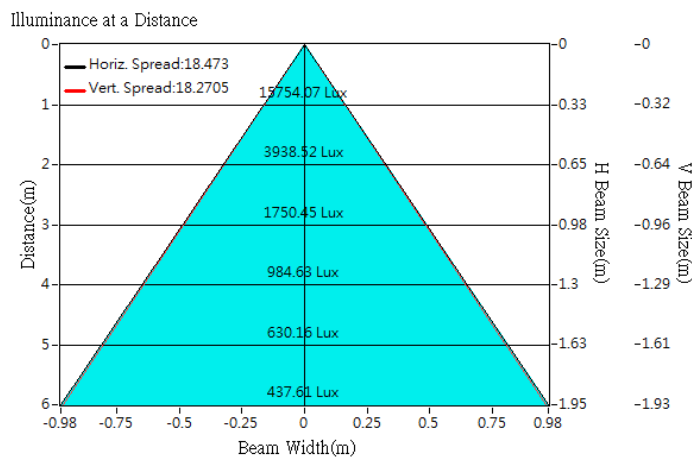



Optical Characteristics

Model Number	CKO-CH15-110058-3701		<p>"H" definition</p>
LED	Fortimo SLM C 1208 L15 2024 G6_PI		
LES / LED Size	Φ 15 mm		
FWHM (D50)	18°		
Field Angle (D10)	36°		
H (distance)	3.5mm		
Dimension	Φ =110 mm, Thickness=57.8 mm		
Luminous Flux	2587 lm	Measured @ 26.9 W	
Material	PC / UL94V2		

cd/klm

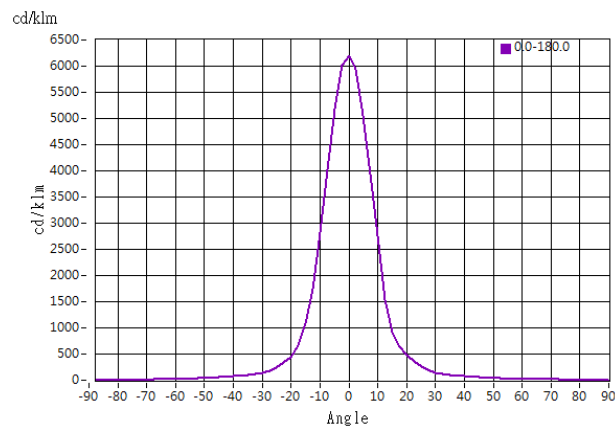

Illuminance At Distances

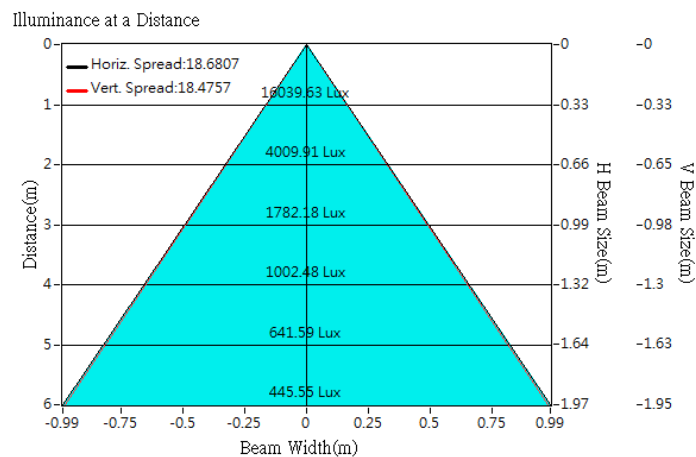



Optical Characteristics

Model Number	CKO-CH15-110058-3701		<p>"H" definition</p>
LED	Fortimo SLM 1211 L19 G6		
LES / LED Size	Φ 19 mm		
FWHM (D50)	22°		
Field Angle (D10)	44°		
H (distance)	4 mm		
Dimension	Φ =110 mm, Thickness=57.8 mm		
Luminous Flux	4924 lm	Measured @ 43.6 W	
Material	PC / UL94V2		

cd/klm

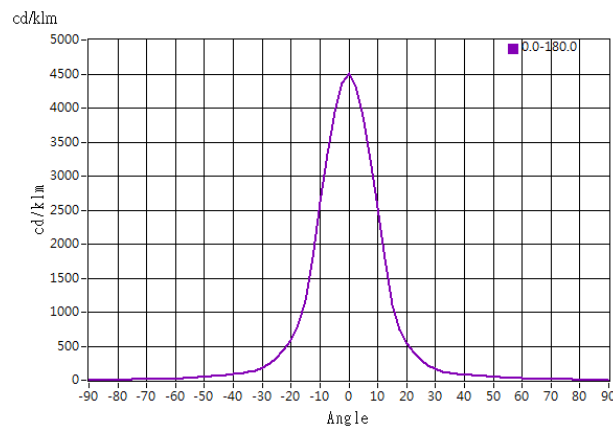

Illuminance At Distances

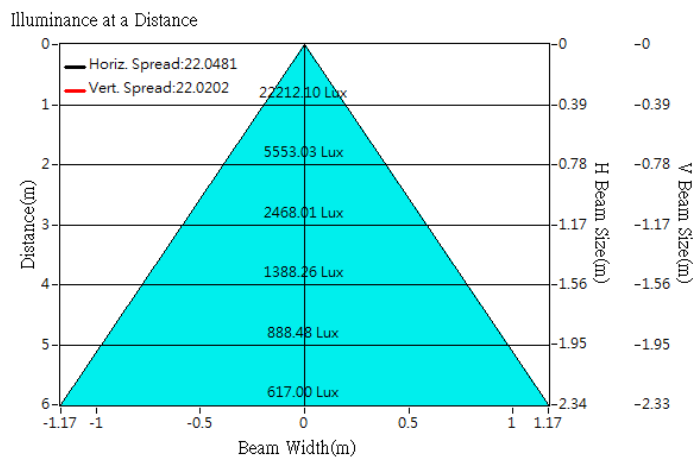



Optical Characteristics

Model Number	CKO-CH15-110058-3701		<p>"H" definition</p>
LED	Fortimo SLM 1211 L22 G7N		
LES / LED Size	Φ 22 mm		
FWHM (D50)	24°		
Field Angle (D10)	50°		
H (distance)	4 mm		
Dimension	Φ =110 mm, Thickness=57.8 mm		
Luminous Flux	3823 lm	Measured @ 34.0 W	
Material	PC / UL94V2		

cd/klm

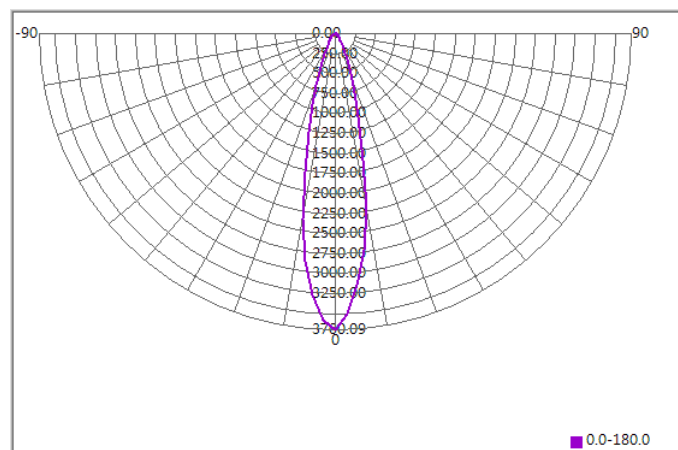

Illuminance At Distances

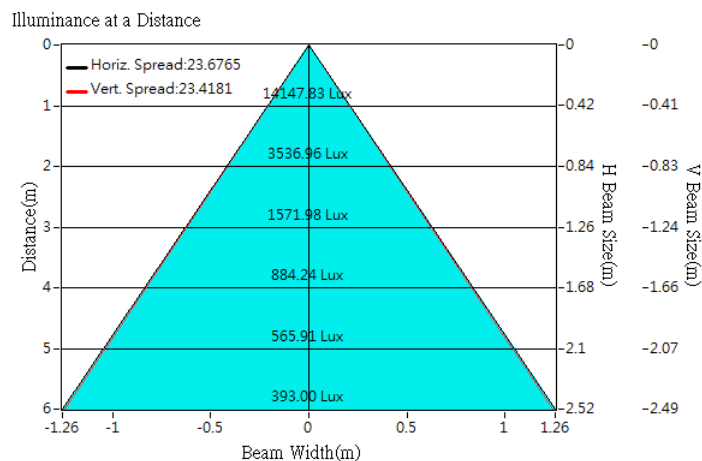



Optical Characteristics

Model Number	CKO-CH15-110058-3701		<p>"H" definition</p>
LED	Fortimo SLM 1212 L22 G7N		
LES / LED Size	Φ 22 mm		
FWHM (D50)	24°		
Field Angle (D10)	50°		
H (distance)	4 mm		
Dimension	Φ =110 mm, Thickness=57.8 mm		
Luminous Flux	4099 lm	Measured @ 37.1 W	
Material	PC / UL94V2		

cd/klm

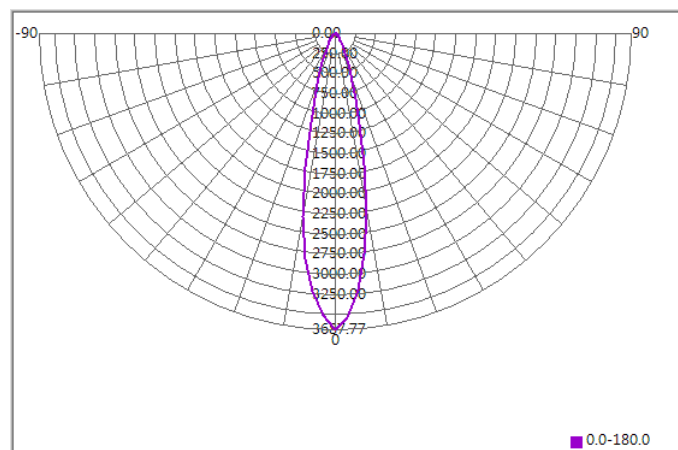

Illuminance At Distances

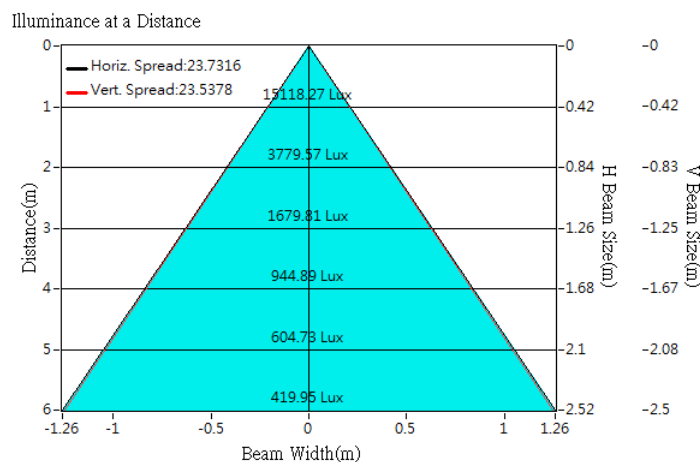



Optical Characteristics

Model Number	CKO-CH15-110058-3701		<p>"H" definition</p>
LED	Fortimo SLM 1216 L23 G6		
LES / LED Size	Φ 23 mm		
FWHM (D50)	25°		
Field Angle (D10)	52°		
H (distance)	4 mm		
Dimension	Φ =110 mm, Thickness=57.8 mm		
Luminous Flux	5115 lm	Measured @ 42.3 W	
Material	PC / UL94V2		

cd/klm

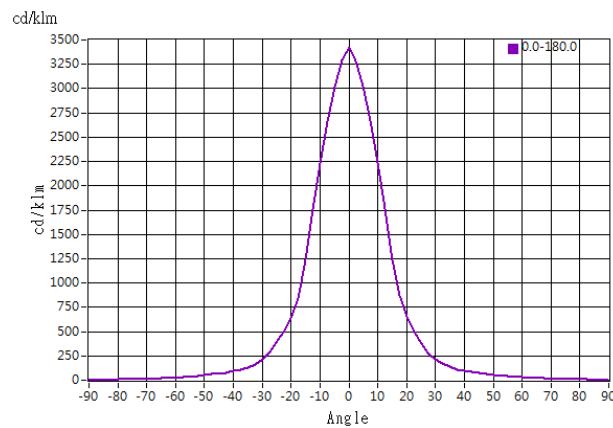

Illuminance At Distances

