



Product Model Number

CKO-CH15-110058-3901

✓ Model Number Definitions

CKO-XXXX-XXXXXX-XXXX



- A. Chun Kuang Optics Corp. Product
- B. Product Type: product abbreviation
Ex:
CH→CoB High Intensity
CC→CoB Compact
CS→Soft Shading for CoB LED
HC→Holder for CoB LED

- C. Identity Code
- D. Lens / Fixture Size
Ex: 075026=Φ75mm / Thickness=26mm (round up)
- C. Serial Numbers

The lens datasheet is applicable for **Citizen LED**, that manufactured by Chun Kuang Optics Corp.

✓ Dimensions (mm) : Φ110 x 58

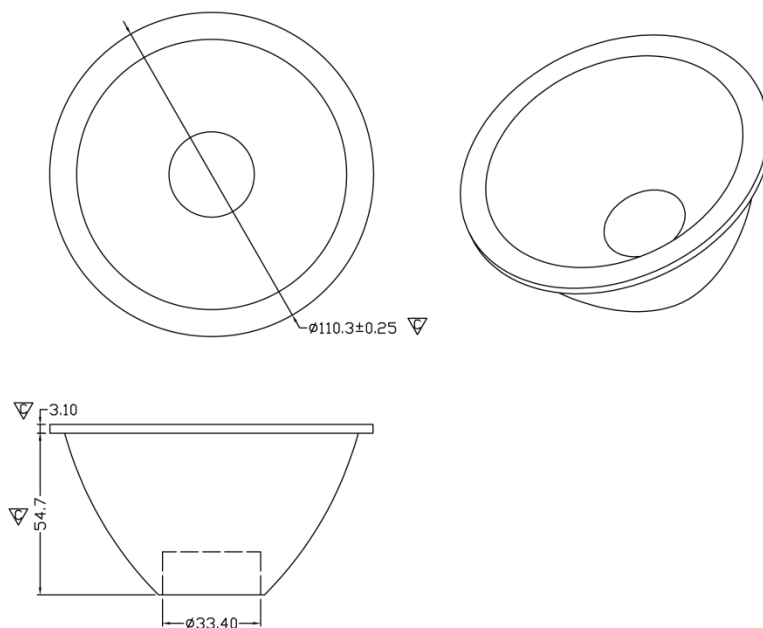

▽:Critical Dimension



Optical Characteristics

Model Number	CKO-CH15-110058-3901		<p>"H" definition</p> <p>LES CoB</p>
LED	CLU 720		
LES / LED Size	Φ 11 mm		
FWHM (D50)	40°		
Field Angle (D10)	68°		
H (distance)	4 mm		
Dimension	Φ =110 mm, Thickness=58 mm		
Luminous Flux	3380 lm	Measured @39 W	
Material	PC / UL94V2		

cd/klm

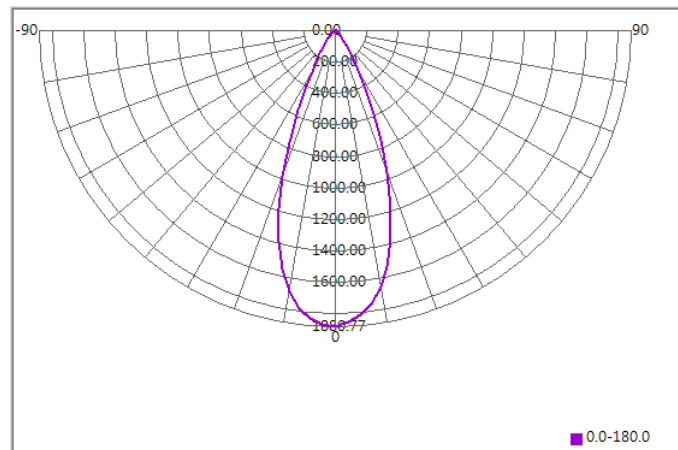

Illuminance At Distances

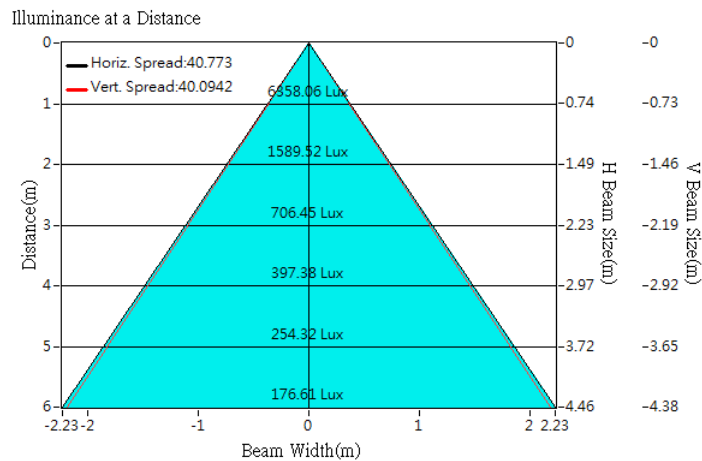



Optical Characteristics

Model Number	CKO-CH15-110058-3901		<p>"H" definition</p>
LED	CLU 730		
LES / LED Size	Φ 13 mm		
FWHM (D50)	42°		
Field Angle (D10)	69°		
H (distance)	4 mm		
Dimension	Φ =110 mm, Thickness=58 mm		
Luminous Flux	5175 lm	Measured @65 W	
Material	PC / UL94V2		

cd/klm

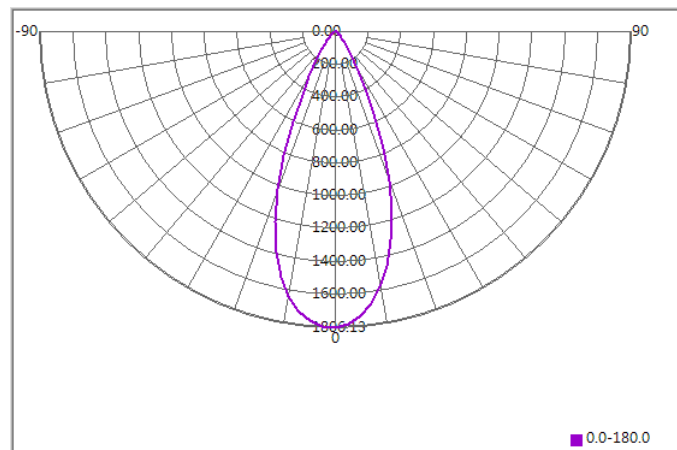

Illuminance At Distances

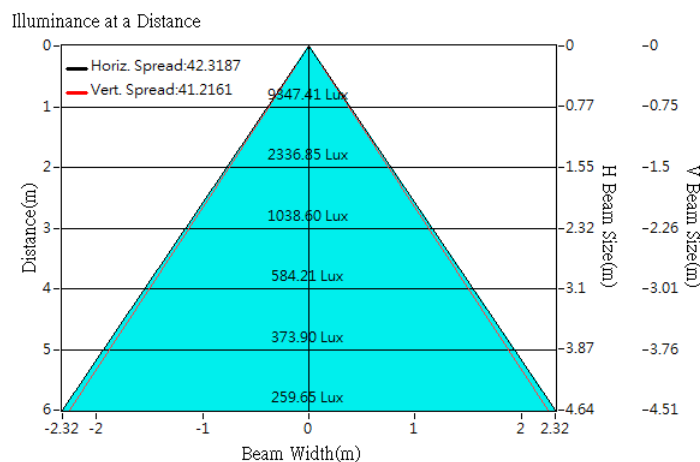



Optical Characteristics

Model Number	CKO-CH15-110058-3901		<p>"H" definition</p>
LED	CLU 038		
LES / LED Size	Φ 14.5 mm		
FWHM (D50)	41°		
Field Angle (D10)	68°		
H (distance)	4 mm		
Dimension	Φ =110 mm, Thickness=58 mm		
Luminous Flux	2884 lm	Measured @25 W	
Material	PC / UL94V2		

cd/klm

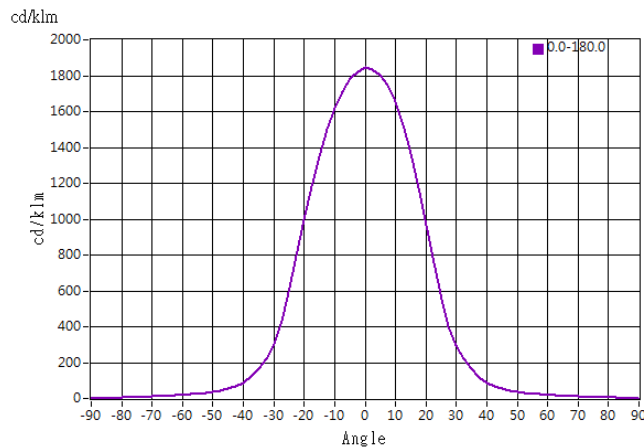

Illuminance At Distances

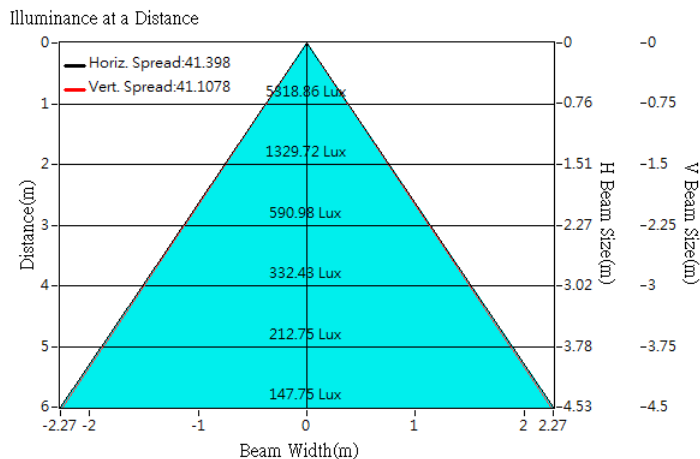



Optical Characteristics

Model Number	CKO-CH15-110058-3901		<p>"H" definition</p>
LED	CLU 046		
LES / LED Size	Φ 22 mm		
FWHM (D50)	45°		
Field Angle (D10)	75°		
H (distance)	4 mm		
Dimension	Φ =110 mm, Thickness=58 mm		
Luminous Flux	4983 lm	Measured @37.4 W	
Material	PC / UL94V2		

cd/klm

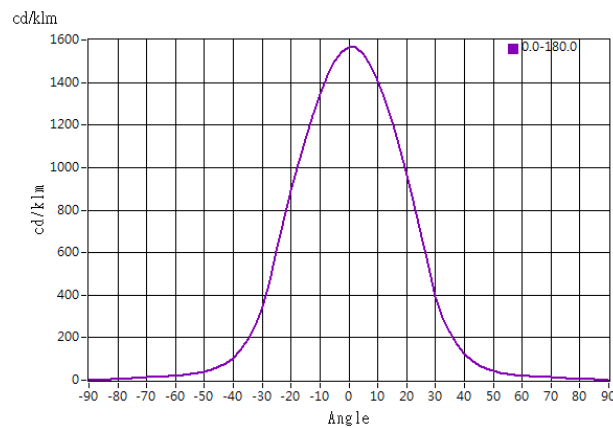

Illuminance At Distances

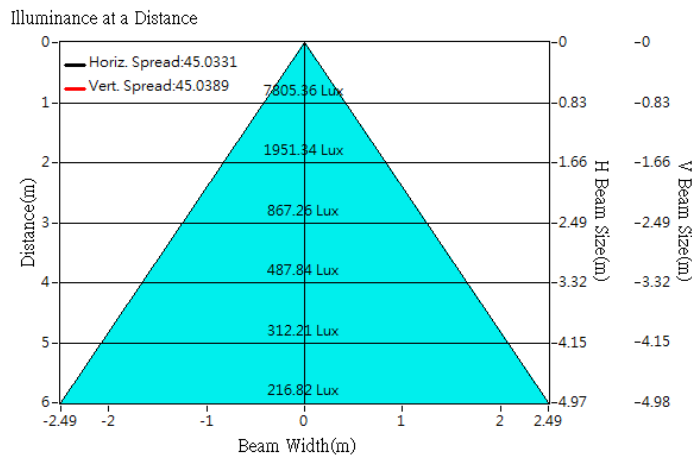



Optical Characteristics

Model Number	CKO-CH15-110058-3901		<p>"H" definition</p>
LED	CLU 048		
LES / LED Size	Φ 22 mm		
FWHM (D50)	45°		
Field Angle (D10)	75°		
H (distance)	4 mm		
Dimension	Φ =110 mm, Thickness=58 mm		
Luminous Flux	6346 lm	Measured @50.3 W	
Material	PC / UL94V2		

cd/klm

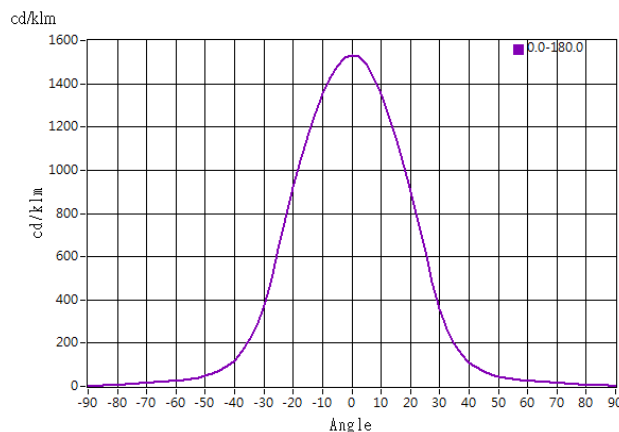

Illuminance At Distances

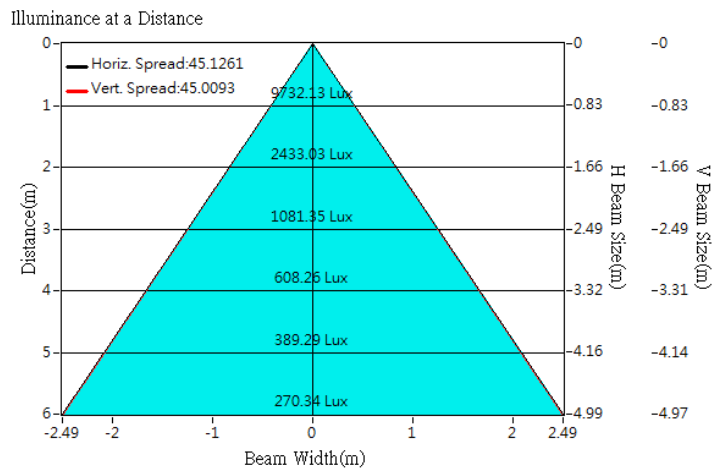



Lens Accessories - CoB Holder

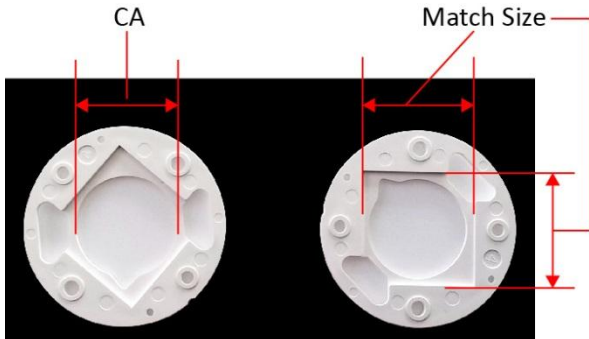

Example of LES Area & LED Size Dimension Locations

Product Model	Match Size (mm)	CA (mm)	Material	Applicability
CKO-HC13-131311-6416	13.8 x 13.8	Φ 11.6	PBT	Citizen CLL020
CKO-HC13-191917-6417	19.3 x 19.3	Φ 17.4	PBT	Citizen CLL030
CKO-HC13-282824-6418	28.3 x 28.3	Φ 24.9	PBT	Citizen CLL040