



Product Model Number

CKO-CH17-045026-0405

✓ Model Number Definitions

CKO-XXXX-XXXXXX-XXXX



- A. Chun Kuang Optics Corp. Product
- B. Product Type: product abbreviation
Ex:
CH→CoB High Intensity
CC→CoB Compact
CS→Soft Shading for CoB LED
HC→Holder for CoB LED

- C. Identity Code
- D. Lens / Fixture Size
Ex: 075026=Φ75mm / Thickness=26mm (round up)
- E. Serial Numbers

The lens datasheet is applicable for **Cree LED**, that manufactured by Chun Kuang Optics Corp.

✓ Dimensions (mm) : Φ 45 x 26

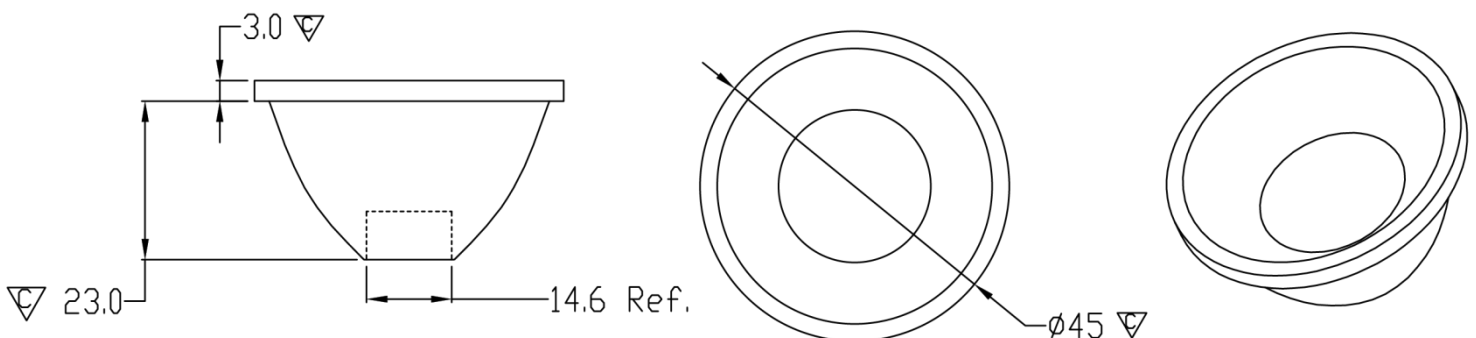

▽:Critical Dimension



✓ Optical Characteristics – Angle Performances

| Cree | LED LES (mm) | FWHM (degrees) | Field Angle (degrees) |
|---------|--------------|----------------|-----------------------|
| XHP50.2 | 5.0 x 5.0 | 35° | 60° |
| XHP70.2 | 7.0 x 7.0 | 35° | 63° |
| CMA1303 | Φ4.5 | 29° | 53° |
| CXA1304 | Φ6 | 31° | 58° |
| CXB1304 | Φ6 | 31° | 57° |
| CMA1306 | Φ6 | 31° | 57° |
| CXB1310 | Φ6 | 31° | 57° |
| CXA1507 | Φ9 | 35° | 64° |
| CXB1507 | Φ9 | 35° | 63° |
| CXA1510 | Φ9 | 35° | 64° |
| CXA1512 | Φ9 | 34° | 63° |
| CXB1512 | Φ9 | 35° | 64° |
| CMA1516 | Φ9 | 35° | 65° |
| CXB1520 | Φ9 | 36° | 64° |
| CMT1407 | Φ9.8 | 35° | 65° |
| CMT1412 | Φ9.8 | 36° | 66° |
| CMT1420 | Φ9.8 | 36° | 65° |
| | | | |
| | | | |
| | | | |
| | | | |
| | | | |
| | | | |
| | | | |
| | | | |
| | | | |



Optical Characteristics

| | | | |
|-------------------|---------------------------|------------------|-----------------------|
| Model Number | CKO-CH17-045026-0405 | | <p>"H" definition</p> |
| LED | XHP50.2 | | |
| LES / LED Size | 5.0 x 5.0 | | |
| FWHM (D50) | 35° | | |
| Field Angle (D10) | 60° | | |
| H (distance) | 2.5 mm | | |
| MCPCB Height | 1.1 mm | | |
| Dimension | Φ =45 mm, Thickness=26 mm | | |
| Luminous Flux | 887 lm | Measured @ 8.9 W | |
| Material | PC / UL94V2 | | |

cd/klm

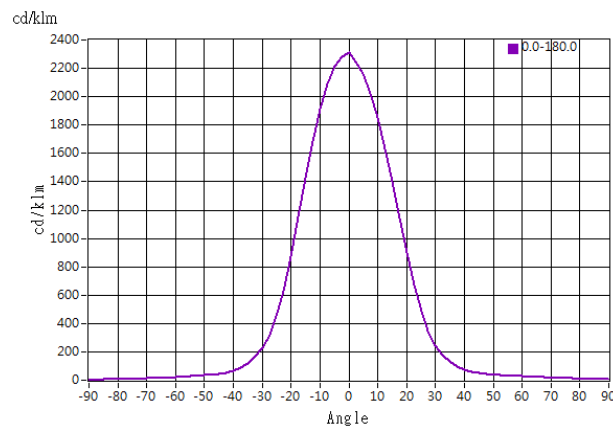

Illuminance At Distances

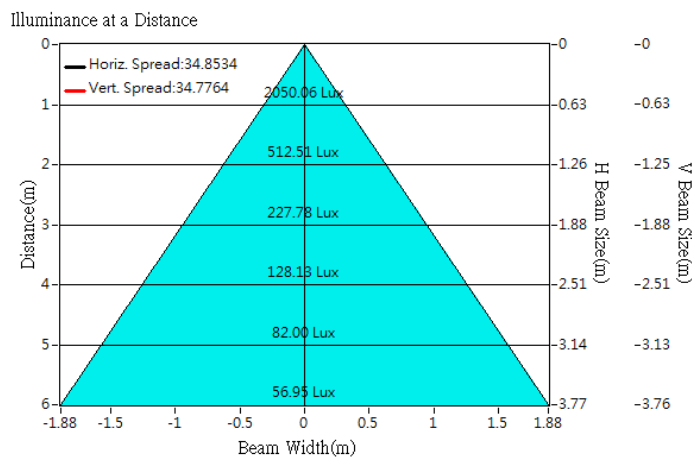



Optical Characteristics

| | | | |
|-------------------|---------------------------|-------------------|-----------------------|
| Model Number | CKO-CH17-045026-0405 | | <p>"H" definition</p> |
| LED | XHP70.2 | | |
| LES / LED Size | 7.0 x 7.0 | | |
| FWHM (D50) | 35° | | |
| Field Angle (D10) | 63° | | |
| H (distance) | 2.5 mm | | |
| MCPCB Height | 1.1 mm | | |
| Dimension | Φ =45 mm, Thickness=26 mm | | |
| Luminous Flux | 1586 lm | Measured @ 14.1 W | |
| Material | PC / UL94V2 | | |

cd/klm

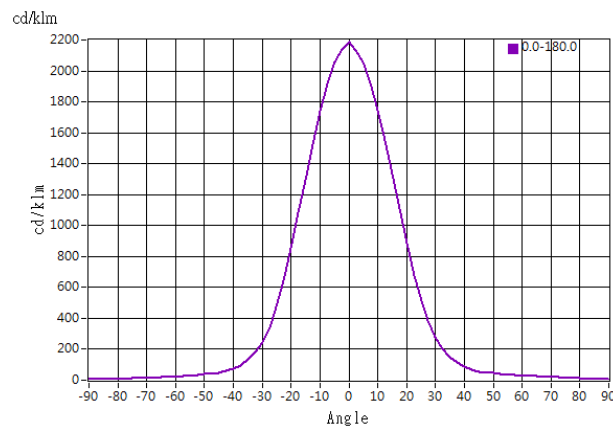

Illuminance At Distances

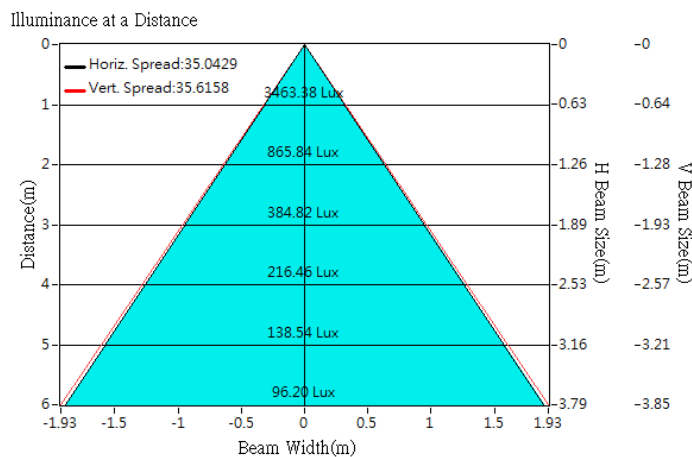



Optical Characteristics

| | | | |
|-------------------|---------------------------|------------------|-----------------------|
| Model Number | CKO-CH17-045026-0405 | | <p>"H" definition</p> |
| LED | CMA1303 | | |
| LES / LED Size | Φ 4.5 mm | | |
| FWHM (D50) | 29° | | |
| Field Angle (D10) | 53° | | |
| H (distance) | 2.5 mm | | |
| Dimension | Φ =45 mm, Thickness=26 mm | | |
| Luminous Flux | 717 lm | Measured @ 6.7 W | |
| Material | PC / UL94V2 | | |

cd/klm

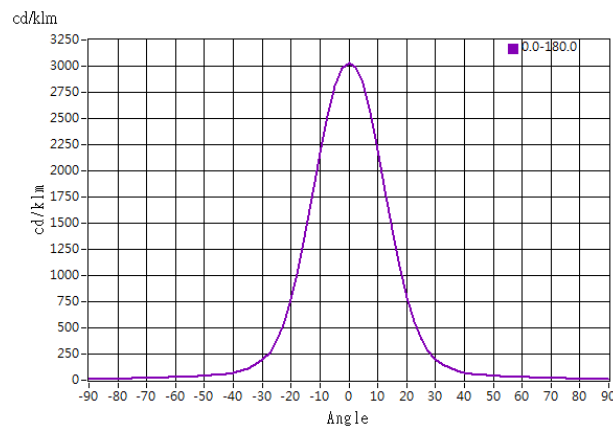

Illuminance At Distances

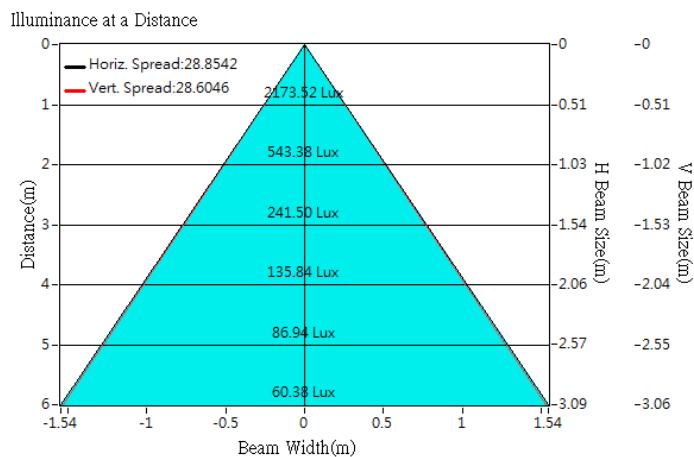



Optical Characteristics

| | | | |
|-------------------|---------------------------|------------------|-----------------------|
| Model Number | CKO-CH17-045026-0405 | | <p>"H" definition</p> |
| LED | CXA1304 | | |
| LES / LED Size | Φ 6 mm | | |
| FWHM (D50) | 31° | | |
| Field Angle (D10) | 58° | | |
| H (distance) | 2.5 mm | | |
| Dimension | Φ =45 mm, Thickness=26 mm | | |
| Luminous Flux | 359 lm | Measured @ 4.1 W | |
| Material | PC / UL94V2 | | |

cd/klm

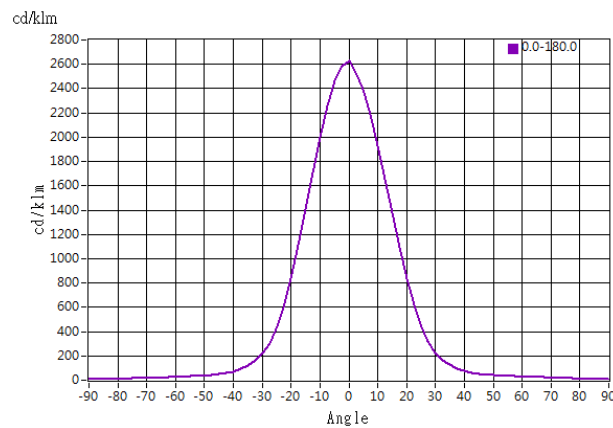

Illuminance At Distances

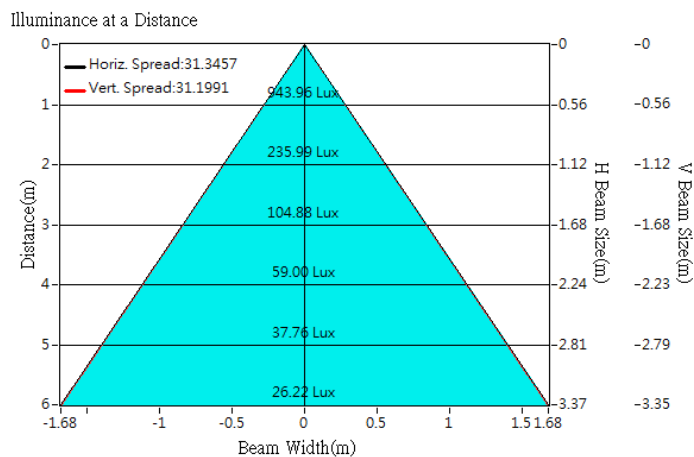



Optical Characteristics

| | | | |
|-------------------|---------------------------|------------------|-----------------------|
| Model Number | CKO-CH17-045026-0405 | | <p>"H" definition</p> |
| LED | CXB1304 | | |
| LES / LED Size | Φ 6 mm | | |
| FWHM (D50) | 31° | | |
| Field Angle (D10) | 57° | | |
| H (distance) | 2.5 mm | | |
| Dimension | Φ =45 mm, Thickness=26 mm | | |
| Luminous Flux | 396 lm | Measured @ 3.5 W | |
| Material | PC / UL94V2 | | |

cd/klm

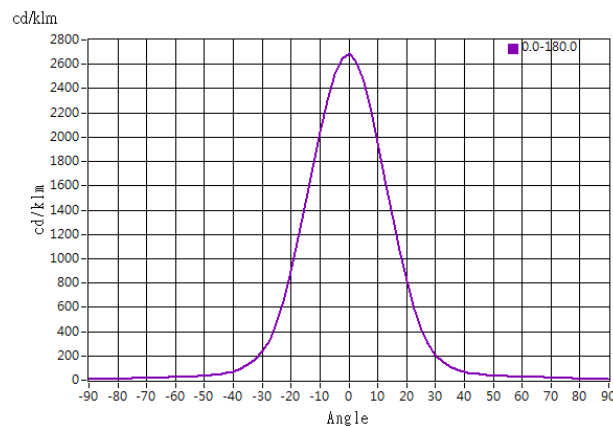

Illuminance At Distances

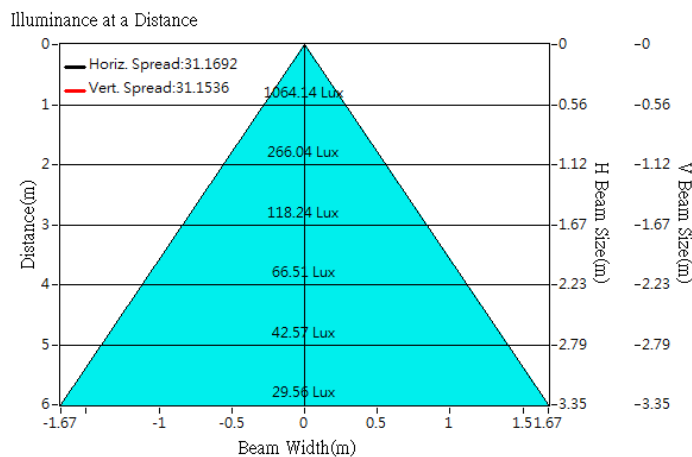



Optical Characteristics

| | | | |
|-------------------|---------------------------|------------------|--|
| Model Number | CKO-CH17-045026-0405 | | <p>"H" definition</p> <p>LES CoB</p> |
| LED | CMA1306 | | |
| LES / LED Size | Φ 6 mm | | |
| FWHM (D50) | 31° | | |
| Field Angle (D10) | 57° | | |
| H (distance) | 2.5 mm | | |
| Dimension | Φ =45 mm, Thickness=26 mm | | |
| Luminous Flux | 899 lm | Measured @ 7.3 W | |
| Material | PC / UL94V2 | | |

cd/klm

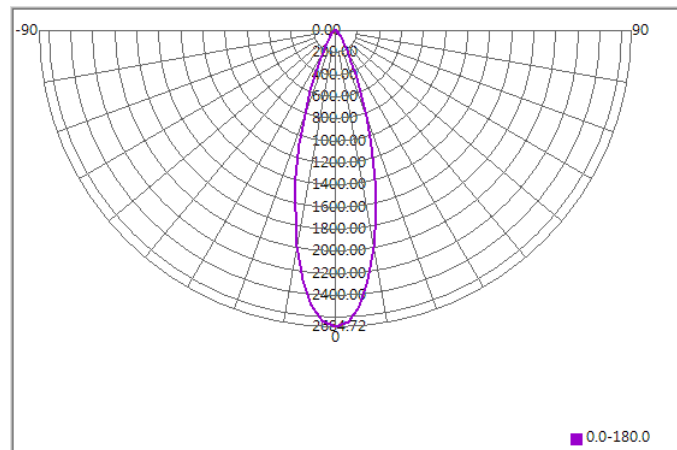

Illuminance At Distances

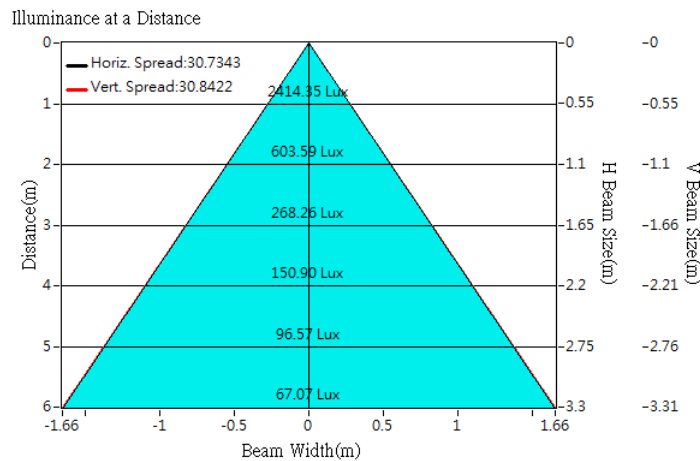



Optical Characteristics

| | | | |
|-------------------|---------------------------|-------------------|-----------------------|
| Model Number | CKO-CH17-045026-0405 | | <p>"H" definition</p> |
| LED | CXB1310 | | |
| LES / LED Size | Φ 6 mm | | |
| FWHM (D50) | 31° | | |
| Field Angle (D10) | 57° | | |
| H (distance) | 2.5 mm | | |
| Dimension | Φ =45 mm, Thickness=26 mm | | |
| Luminous Flux | 1386 lm | Measured @ 12.3 W | |
| Material | PC / UL94V2 | | |

cd/klm

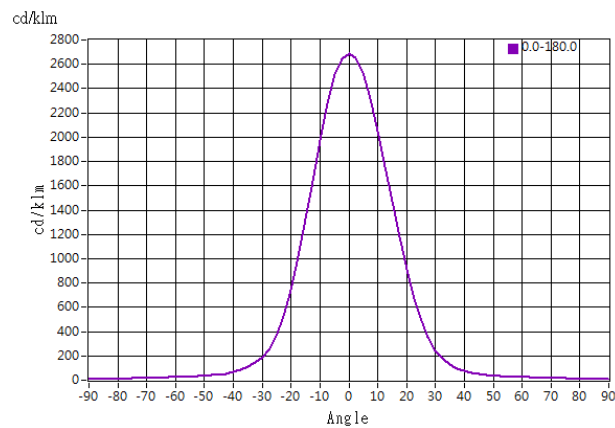

Illuminance At Distances

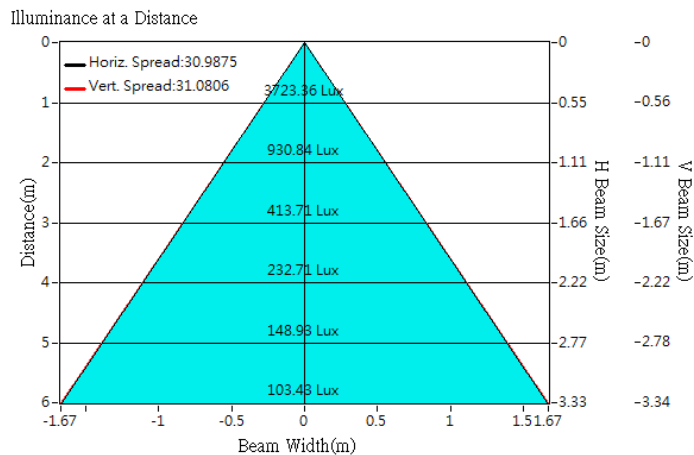



Optical Characteristics

| | | | |
|-------------------|---------------------------|------------------|--|
| Model Number | CKO-CH17-045026-0405 | | <p>"H" definition</p> <p>LES CoB</p> |
| LED | CXA1507 | | |
| LES / LED Size | Φ 9 mm | | |
| FWHM (D50) | 35° | | |
| Field Angle (D10) | 63° | | |
| H (distance) | 2.5 mm | | |
| Dimension | Φ =45 mm, Thickness=26 mm | | |
| Luminous Flux | 658 lm | Measured @ 7.6 W | |
| Material | PC / UL94V2 | | |

cd/klm

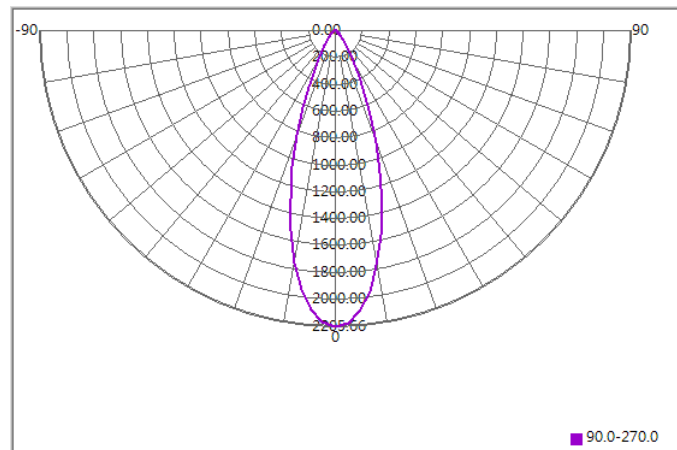

Illuminance At Distances

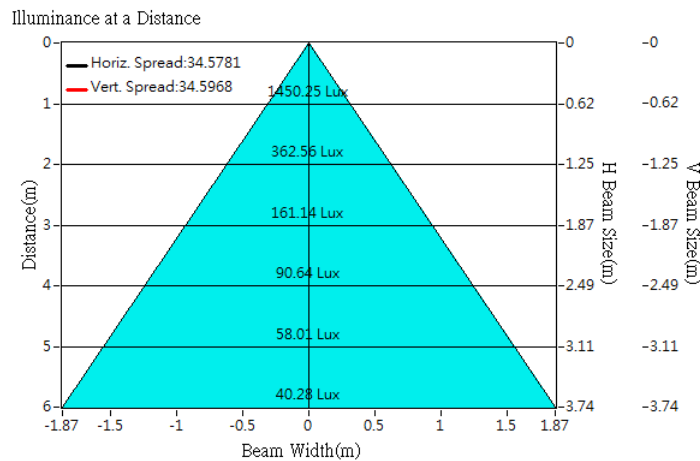



Optical Characteristics

| | | | |
|-------------------|---------------------------|------------------|-----------------------|
| Model Number | CKO-CH17-045026-0405 | | <p>"H" definition</p> |
| LED | CXB1507 | | |
| LES / LED Size | Φ 9 mm | | |
| FWHM (D50) | 35° | | |
| Field Angle (D10) | 63° | | |
| H (distance) | 2.5 mm | | |
| Dimension | Φ =45 mm, Thickness=26 mm | | |
| Luminous Flux | 819 lm | Measured @ 7.1 W | |
| Material | PC / UL94V2 | | |

cd/klm

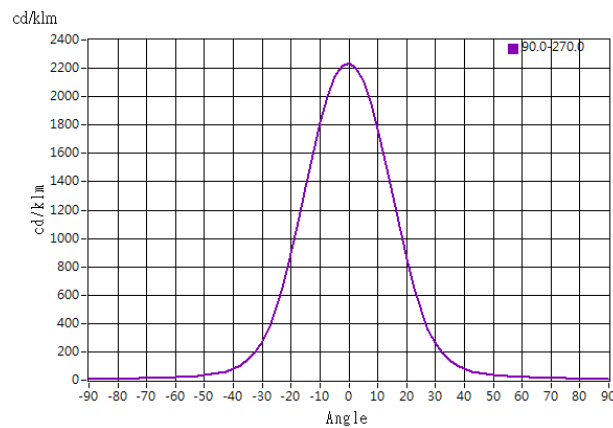

Illuminance At Distances

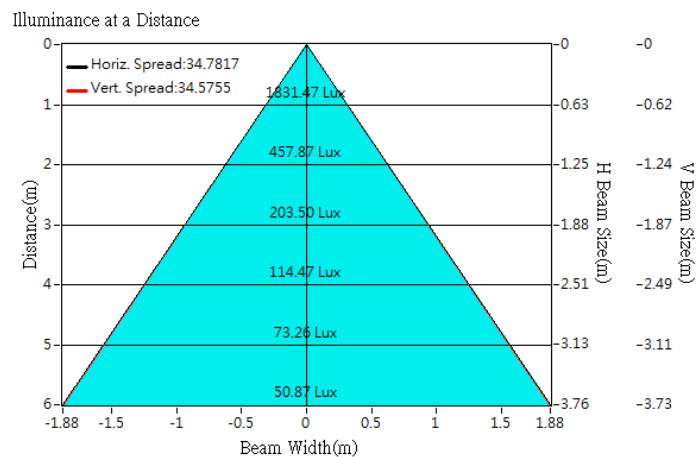



Optical Characteristics

| | | |
|-------------------|---------------------------|--|
| Model Number | CKO-CH17-045026-0405 | <p>"H" definition</p> <p>LES CoB</p> |
| LED | CXA1510 | |
| LES / LED Size | Φ 9 mm | |
| FWHM (D50) | 35° | |
| Field Angle (D10) | 63° | |
| H (distance) | 2.5 mm | |
| Dimension | Φ =45 mm, Thickness=26 mm | |
| Luminous Flux | 971 lm | |
| Material | PC / UL94V2 | |

cd/klm

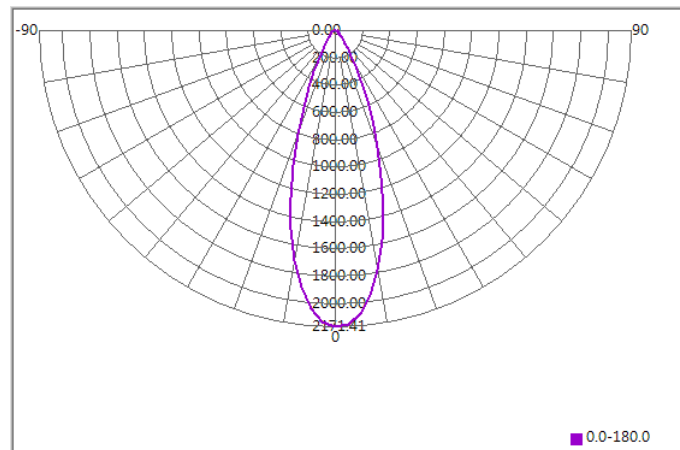

Illuminance At Distances

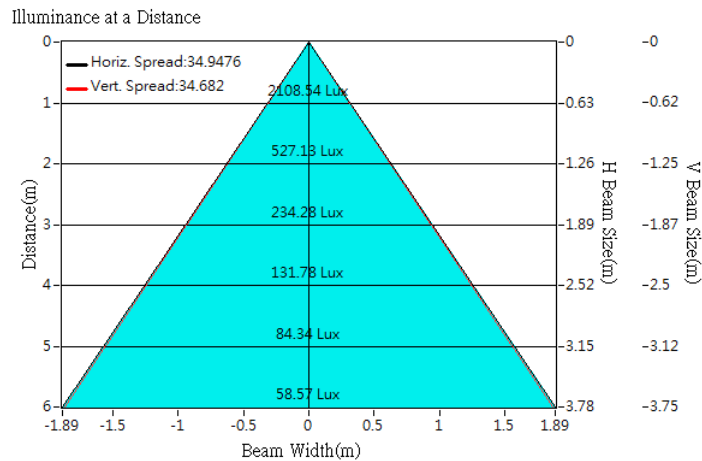



Optical Characteristics

| | | | |
|-------------------|---------------------------|---|-------------------|
| Model Number | CKO-CH17-045026-0405 | <p>"H" definition</p> <p>The diagram illustrates the 'H' definition as the distance from the LED surface to the center of the beam at a specific distance. It shows a cross-section of the LED and the beam's spread.</p> | |
| LED | CXA1512 | | |
| LES / LED Size | Φ 9 mm | | |
| FWHM (D50) | 34° | | |
| Field Angle (D10) | 63° | | |
| H (distance) | 2.5 mm | | |
| Dimension | Φ =45 mm, Thickness=26 mm | | |
| Luminous Flux | 1173 lm | | Measured @ 13.2 W |
| Material | PC / UL94V2 | | |

cd/klm

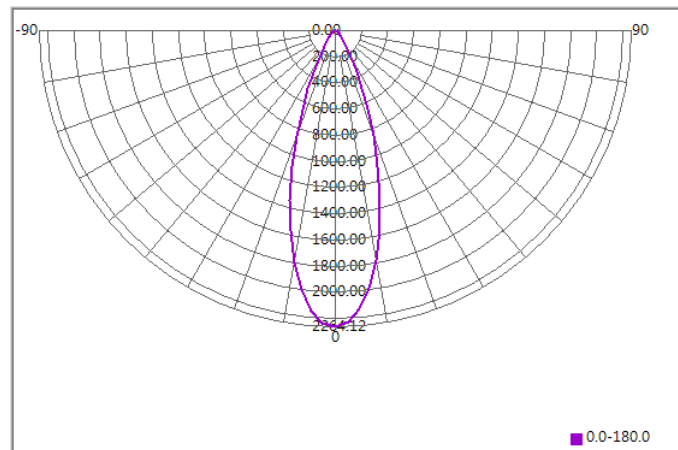

Illuminance At Distances

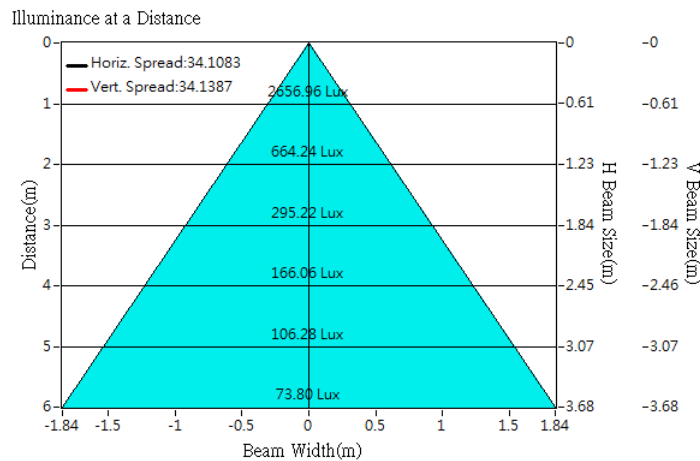

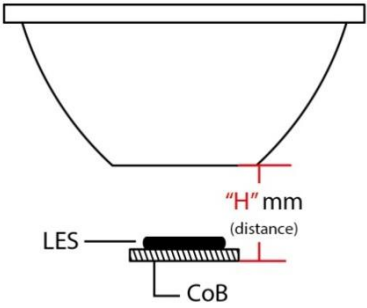

Optical Characteristics

| | | | |
|-------------------|---------------------------|-------------------|--|
| Model Number | CKO-CH17-045026-0405 | | <p>"H" definition</p>  |
| LED | CXB1512 | | |
| LES / LED Size | Φ 9 mm | | |
| FWHM (D50) | 35° | | |
| Field Angle (D10) | 64° | | |
| H (distance) | 2.5 mm | | |
| Dimension | Φ =45 mm, Thickness=26 mm | | |
| Luminous Flux | 1338 lm | Measured @ 12.4 W | |
| Material | PC / UL94V2 | | |

cd/klm

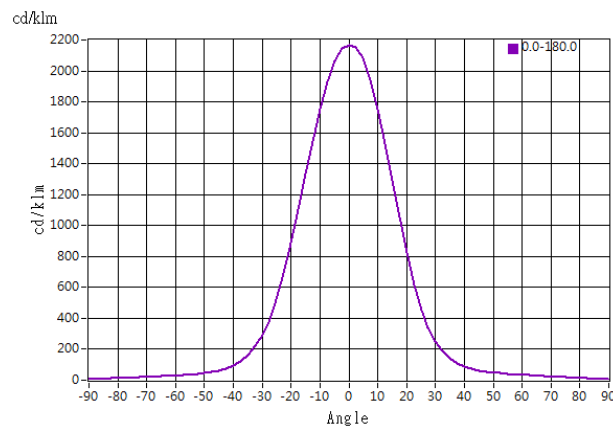

Illuminance At Distances

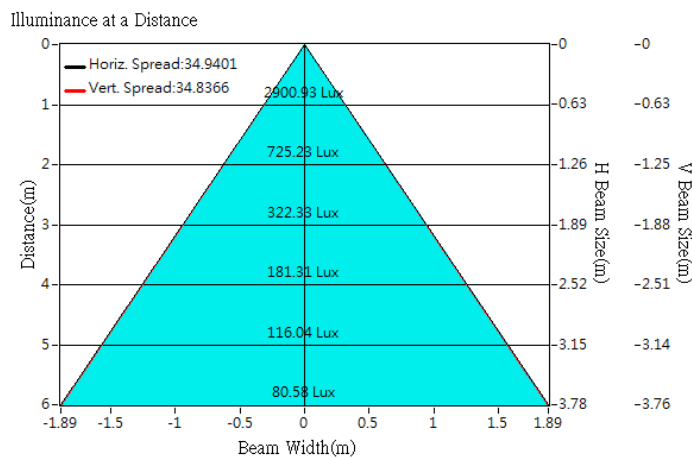



Optical Characteristics

| | | | |
|-------------------|---------------------------|-------------------|-----------------------|
| Model Number | CKO-CH17-045026-0405 | | <p>"H" definition</p> |
| LED | CMA1516 | | |
| LES / LED Size | Φ 9 mm | | |
| FWHM (D50) | 35° | | |
| Field Angle (D10) | 65° | | |
| H (distance) | 2.5 mm | | |
| Dimension | Φ =45 mm, Thickness=26 mm | | |
| Luminous Flux | 1880 lm | Measured @ 15.5 W | |
| Material | PC / UL94V2 | | |

cd/klm

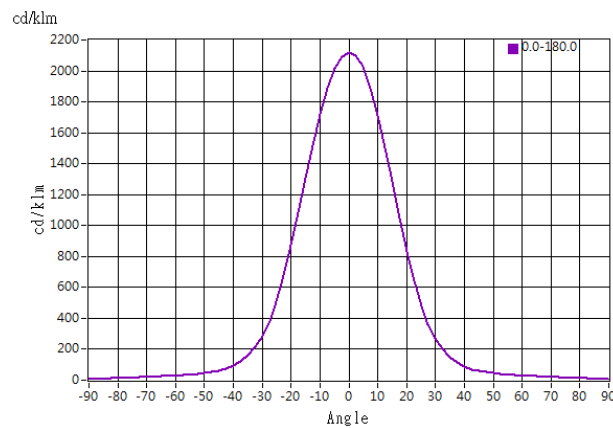

Illuminance At Distances

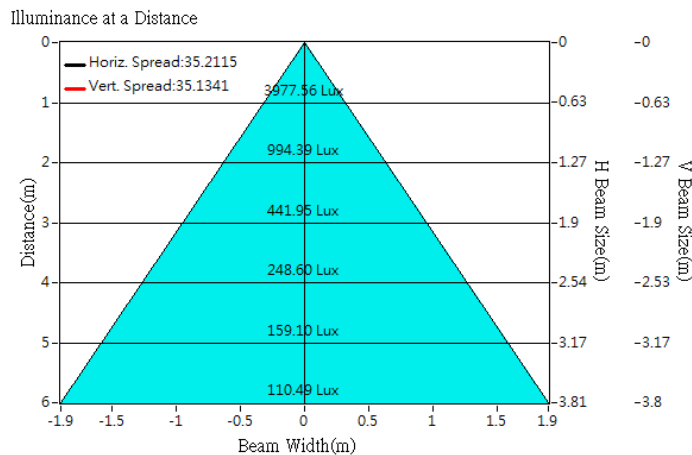



Optical Characteristics

| | | | |
|-------------------|---------------------------|-------------------|-----------------------|
| Model Number | CKO-CH17-045026-0405 | | <p>"H" definition</p> |
| LED | CXB1520 | | |
| LES / LED Size | Φ 9 mm | | |
| FWHM (D50) | 36° | | |
| Field Angle (D10) | 64° | | |
| H (distance) | 2.5 mm | | |
| Dimension | Φ =45 mm, Thickness=26 mm | | |
| Luminous Flux | 1927 lm | Measured @ 17.3 W | |
| Material | PC / UL94V2 | | |

cd/klm

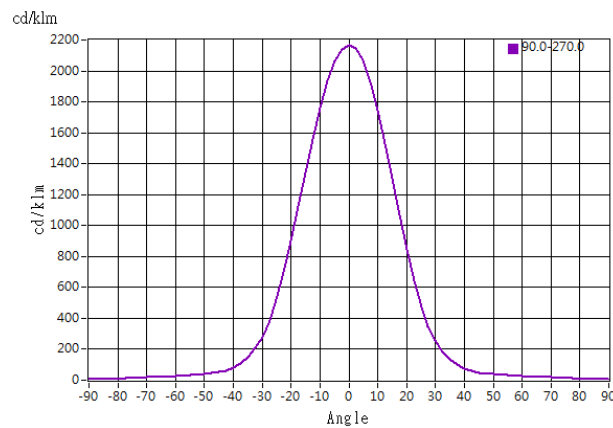

Illuminance At Distances

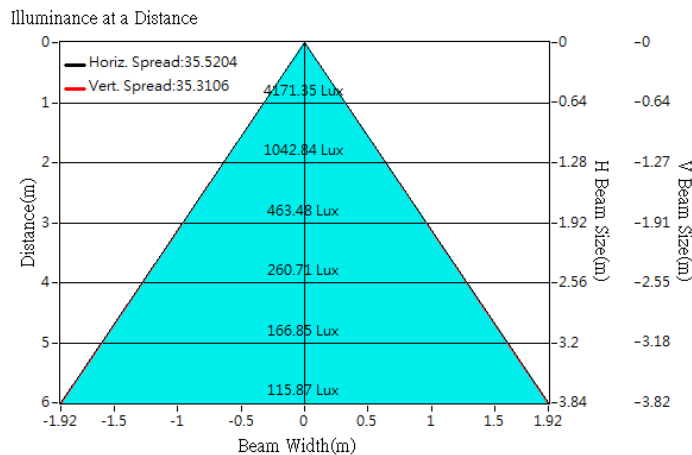



Optical Characteristics

| | | | |
|-------------------|---------------------------|------------------|-----------------------|
| Model Number | CKO-CH17-045026-0405 | | <p>"H" definition</p> |
| LED | CMT1407 | | |
| LES / LED Size | Φ 9.8 mm | | |
| FWHM (D50) | 35° | | |
| Field Angle (D10) | 65° | | |
| H (distance) | 2.5 mm | | |
| Dimension | Φ =45 mm, Thickness=26 mm | | |
| Luminous Flux | 858 lm | Measured @ 7.0 W | |
| Material | PC / UL94V2 | | |

cd/klm

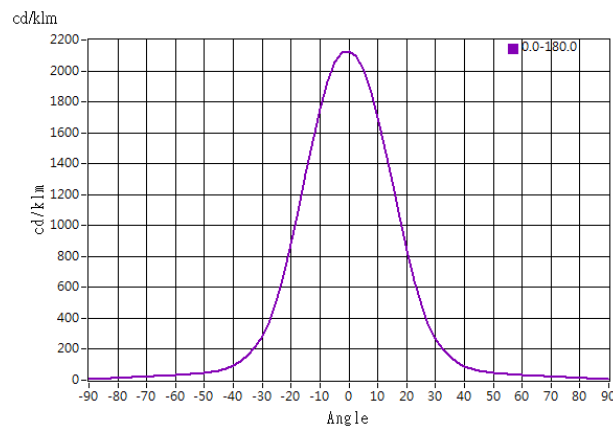

Illuminance At Distances

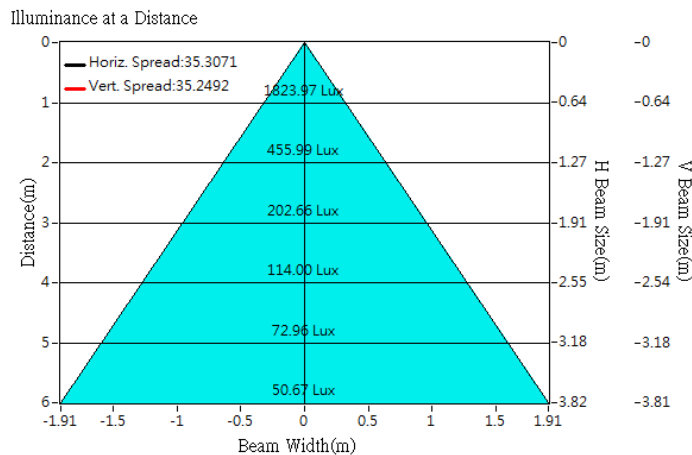

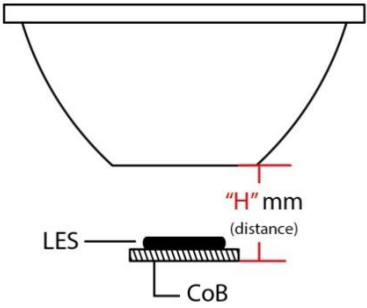

Optical Characteristics

| | | |
|-------------------|--------------------------------|--|
| Model Number | CKO-CH17-045026-0405 | <p>"H" definition</p>  |
| LED | CMT1412 | |
| LES / LED Size | Φ 9.8 mm | |
| FWHM (D50) | 36° | |
| Field Angle (D10) | 66° | |
| H (distance) | 2.5 mm | |
| Dimension | Φ =45 mm, Thickness=26 mm | |
| Luminous Flux | 1518 lm Measured @ 12.2 W | |
| Material | PC / UL94V2 | |

cd/klm

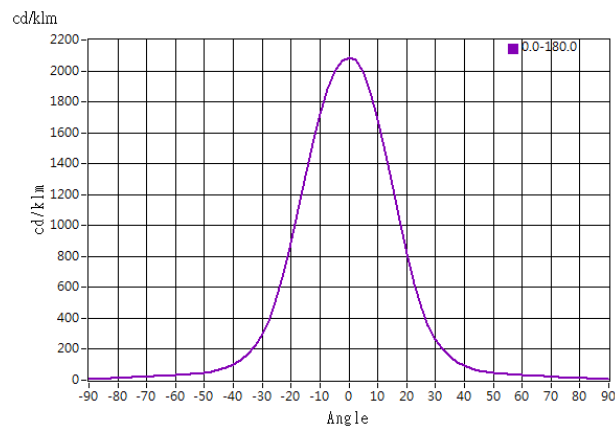

Illuminance At Distances

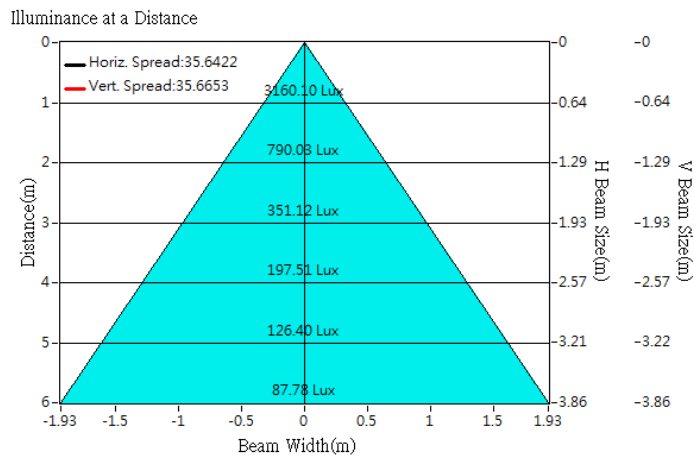



Optical Characteristics

| | | | |
|-------------------|---------------------------|-----------------|-----------------------|
| Model Number | CKO-CH17-045026-0405 | | <p>"H" definition</p> |
| LED | CMT1420 | | |
| LES / LED Size | Φ 9.8 mm | | |
| FWHM (D50) | 36° | | |
| Field Angle (D10) | 65° | | |
| H (distance) | 2.5 mm | | |
| Dimension | Φ =45 mm, Thickness=26 mm | | |
| Luminous Flux | 2201 lm | Measured @ 19 W | |
| Material | PC / UL94V2 | | |

cd/klm

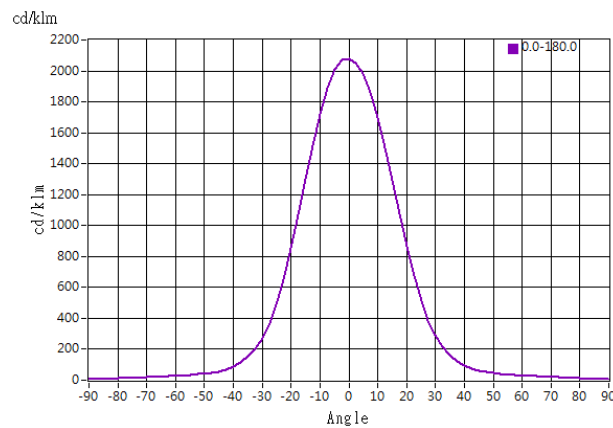

Illuminance At Distances

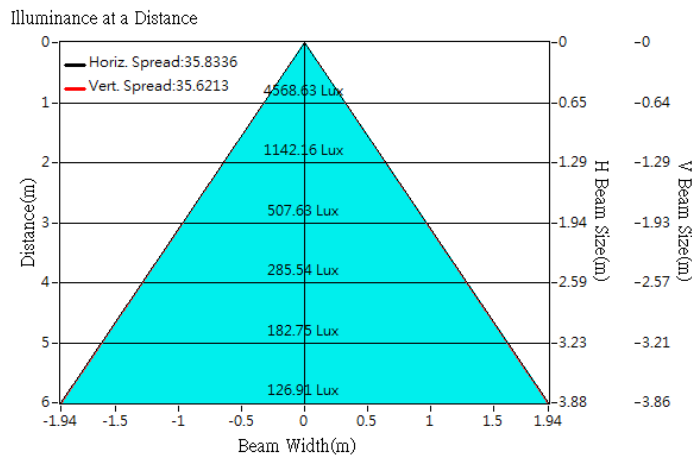



Lens Accessories - CoB Holder

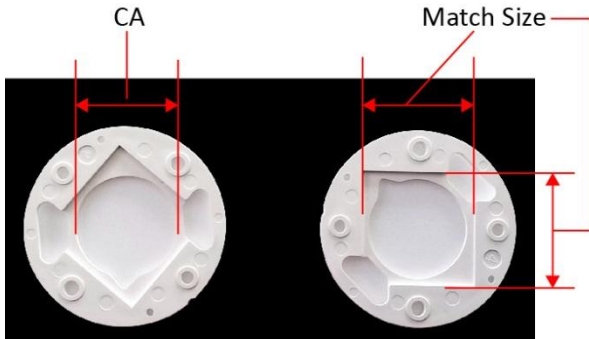

Example of LES Area & LED Size Dimension Locations

| Product Model | Match Size (mm) | CA (mm) | Material | Applicability |
|----------------------|-----------------|---------|----------|---------------|
| CKO-HC13-131307-6411 | 13.6 x 13.6 | Φ 7.8 | PBT | CREE CXA 13XX |
| CKO-HC13-161610-6412 | 16.1 x 16.1 | Φ 10.8 | PBT | CREE CXA 15XX |
| CKO-HC13-181816-6413 | 18.1 x 18.1 | Φ 16.4 | PBT | CREE CXA 18XX |
| CKO-HC13-242421-6414 | 24.1 x 24.1 | Φ 21.3 | PBT | CREE CXA 25XX |
| CKO-HC13-272725-6415 | 27.6 x 27.6 | Φ 25.3 | PBT | CREE CXA 30XX |