



## Product Model Number

CKO-CH17-060033-0205

### ✓ Model Number Definitions

**CKO-XXXX-XXXXXX-XXXX**



- A. Chun Kuang Optics Corp. Product
- B. Product Type: product abbreviation  
Ex:  
CH→CoB High Intensity  
CC→CoB Compact  
CS→Soft Shading for CoB LED  
HC→Holder for CoB LED

- C. Identity Code
- D. Lens / Fixture Size  
Ex: 075026=Φ75mm / Thickness=26mm (round up)
- C. Serial Numbers

The lens datasheet is applicable for **Philips LED**, that manufactured by Chun Kuang Optics Corp.

### ✓ Dimensions (mm) : Φ 60 x 32.6

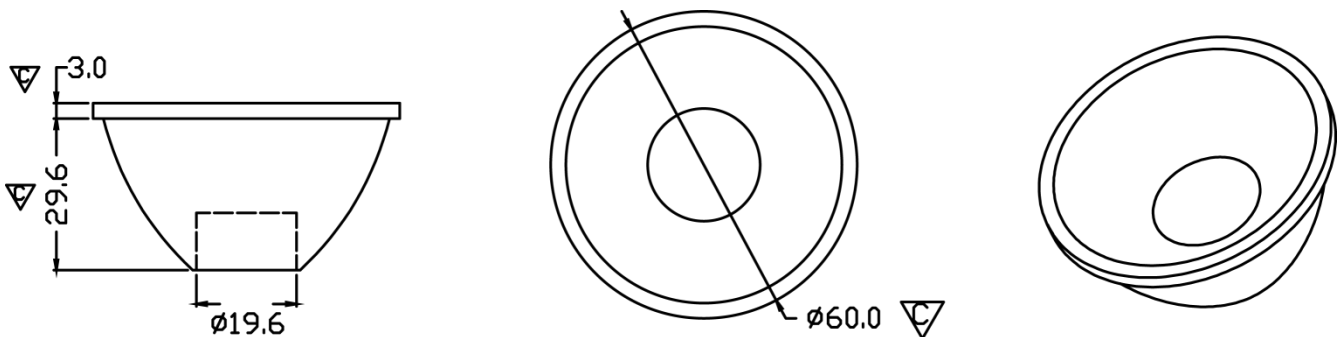

▽:Critical Dimension





## Optical Characteristics

Model Number	CKO-CH17-060033-0205	<p>"H" definition</p>
LED	<b>Fortimo SLM 1203 L09 G6</b>	
LES / LED Size	Φ 9 mm	
FWHM (D50)	35°	
Field Angle (D10)	64°	
H (distance)	3.65mm	
Dimension	Φ =60 mm, Thickness=32.6 mm	
Luminous Flux	1206 lm	
Material	PC / UL94V2	

## cd/klm

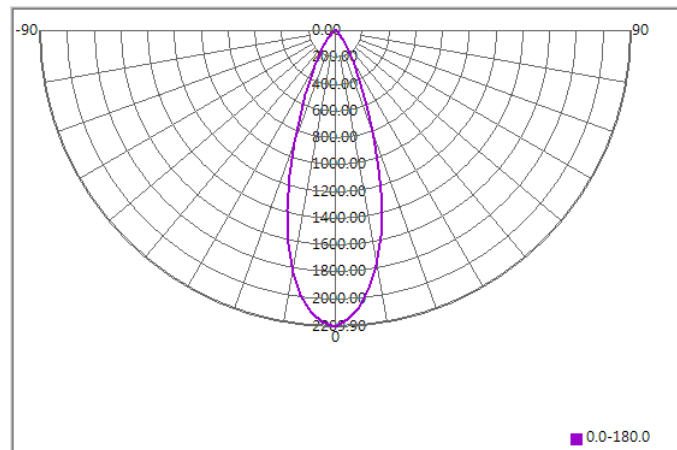

## Illuminance At Distances

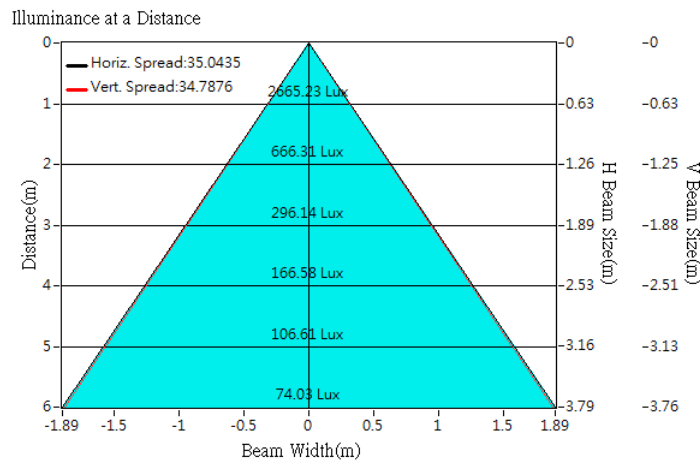



## Optical Characteristics

Model Number	CKO-CH17-060033-0205		<p>"H" definition</p>
LED	Fortimo SLM 1204 L09 G7		
LES / LED Size	Φ 9 mm		
FWHM (D50)	34°		
Field Angle (D10)	62°		
H (distance)	3.65mm		
Dimension	Φ =60 mm, Thickness=32.6 mm		
Luminous Flux	2072 lm	Measured @ 26.2 W	
Material	PC / UL94V2		

## cd/klm

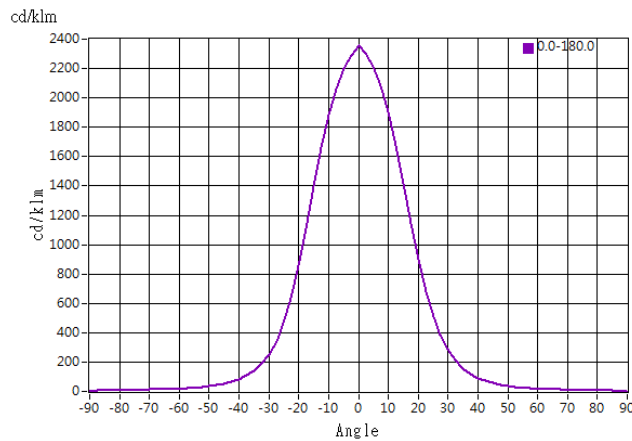

## Illuminance At Distances

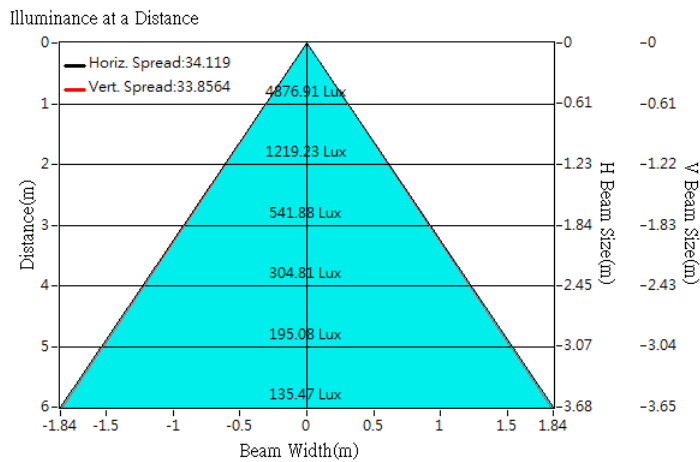



## Optical Characteristics

Model Number	CKO-CH17-060033-0205		<p>"H" definition</p>
LED	Fortimo SLM 1201 L09 G7N		
LES / LED Size	Φ 9.8 mm		
FWHM (D50)	35°		
Field Angle (D10)	64°		
H (distance)	3.65mm		
Dimension	Φ =60 mm, Thickness=32.6 mm		
Luminous Flux	453 lm	Measured @ 3.0 W	
Material	PC / UL94V2		

## cd/klm

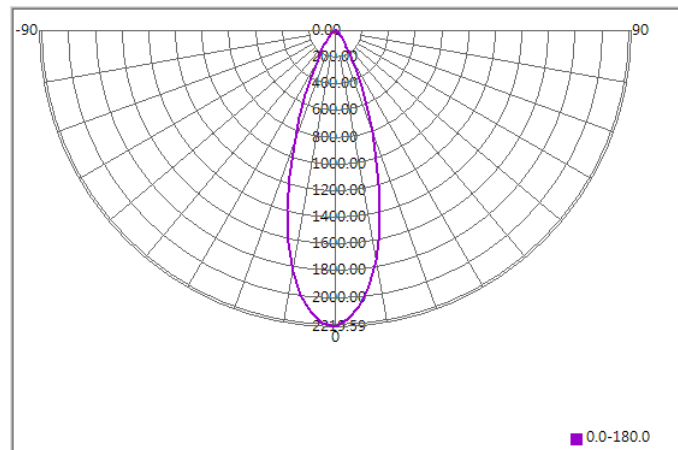

## Illuminance At Distances

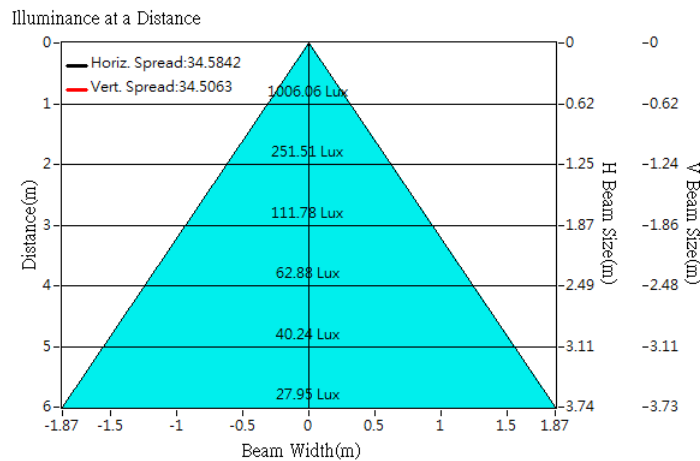



## Optical Characteristics

Model Number	CKO-CH17-060033-0205		<p>"H" definition</p>
LED	Fortimo SLM 1202 L09 G7N		
LES / LED Size	Φ 9.8 mm		
FWHM (D50)	35°		
Field Angle (D10)	65°		
H (distance)	3.65mm		
Dimension	Φ =60 mm, Thickness=32.6 mm		
Luminous Flux	885 lm	Measured @ 6.2 W	
Material	PC / UL94V2		

## cd/klm

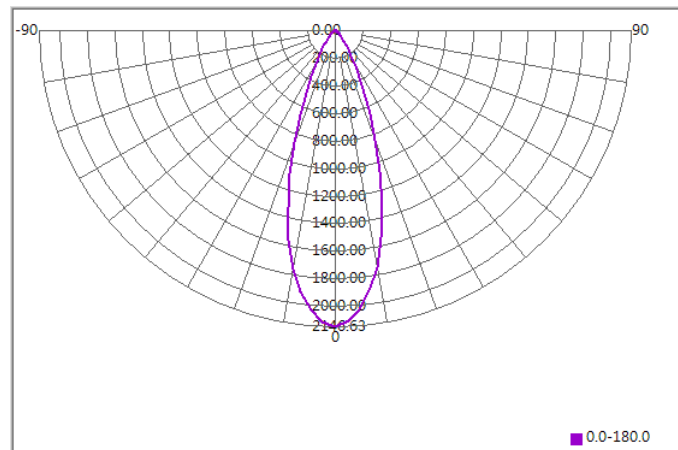

## Illuminance At Distances

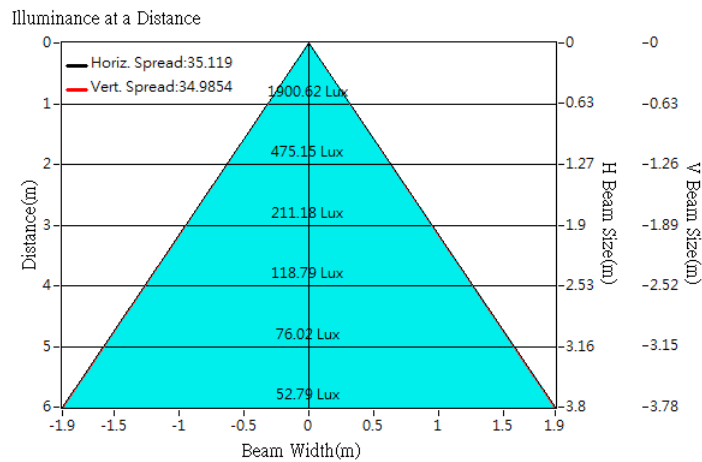



## Optical Characteristics

Model Number	CKO-CH17-060033-0205		<p>"H" definition</p>
LED	Fortimo SLM 1203 L09 G7N		
LES / LED Size	Φ 9.8 mm		
FWHM (D50)	35°		
Field Angle (D10)	65°		
H (distance)	3.65mm		
Dimension	Φ =60 mm, Thickness=32.6 mm		
Luminous Flux	1308 lm	Measured @ 9.2 W	
Material	PC / UL94V2		

## cd/klm

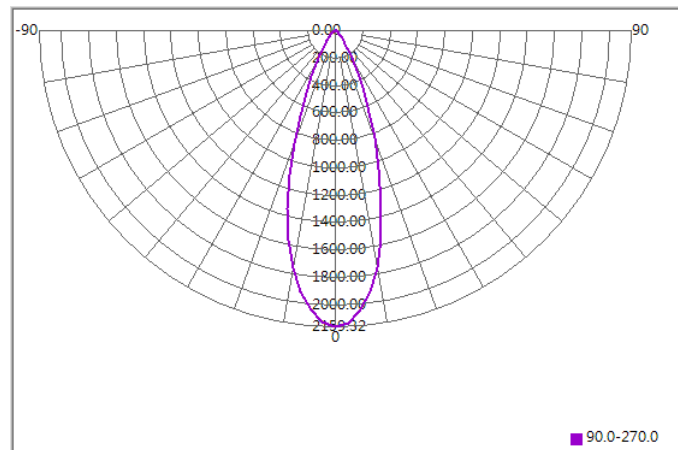

## Illuminance At Distances

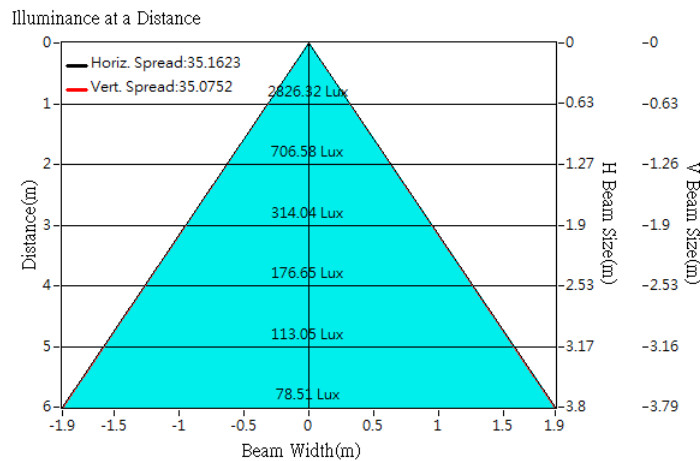



## Optical Characteristics

Model Number	CKO-CH17-060033-0205		<p>"H" definition</p>
LED	Fortimo SLM 1204 L09 G7N		
LES / LED Size	Φ 9.8 mm		
FWHM (D50)	34°		
Field Angle (D10)	64°		
H (distance)	3.65mm		
Dimension	Φ =60 mm, Thickness=32.6 mm		
Luminous Flux	1721 lm	Measured @ 12.3 W	
Material	PC / UL94V2		

## cd/klm

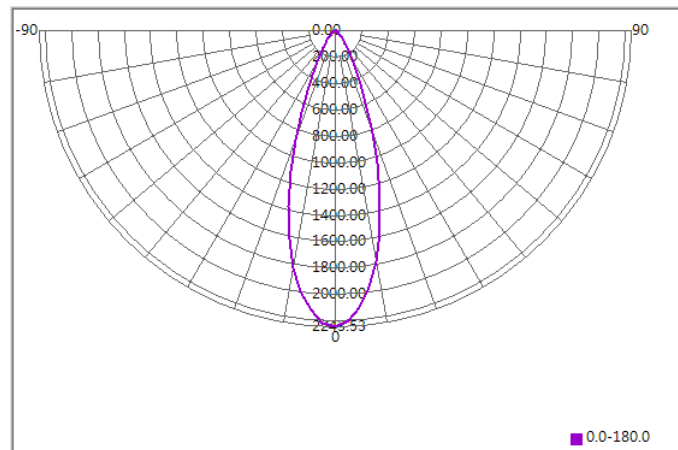

## Illuminance At Distances

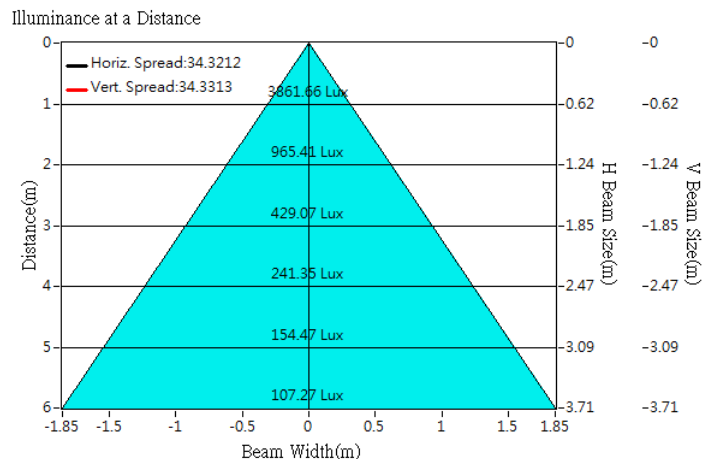



## Optical Characteristics

Model Number	CKO-CH17-060033-0205		<p>"H" definition</p>
LED	Fortimo SLM 830 1205 L13 G7		
LES / LED Size	Φ 13 mm		
FWHM (D50)	38°		
Field Angle (D10)	70°		
H (distance)	3.65mm		
Dimension	Φ =60 mm, Thickness=32.6 mm		
Luminous Flux	1844 lm	Measured @ 17.3 W	
Material	PC / UL94V2		

## cd/klm

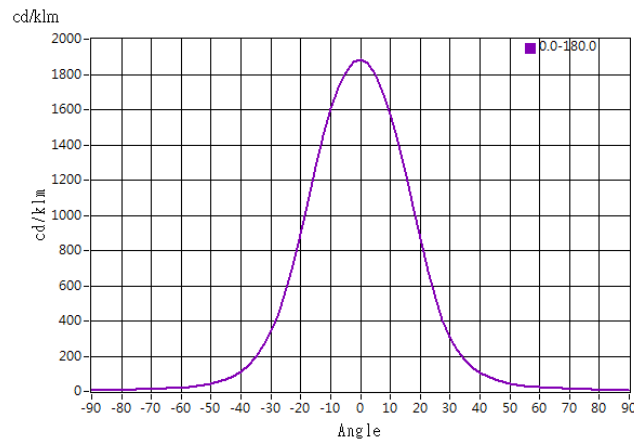

## Illuminance At Distances

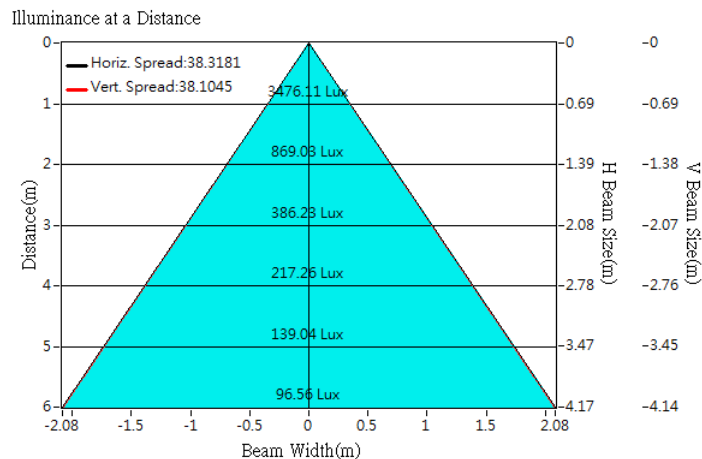



## Optical Characteristics

Model Number	CKO-CH17-060033-0205		<p>"H" definition</p> <p>LES CoB</p>
LED	Fortimo SLM PW 1205 L13 G6		
LES / LED Size	Φ 13 mm		
FWHM (D50)	39°		
Field Angle (D10)	71°		
H (distance)	3.65mm		
Dimension	Φ =60 mm, Thickness=32.6 mm		
Luminous Flux	1994 lm	Measured @ 17.7 W	
Material	PC / UL94V2		

## cd/klm

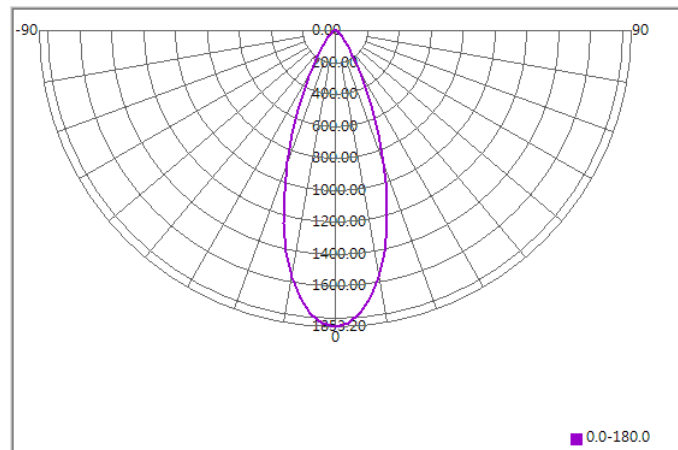

## Illuminance At Distances

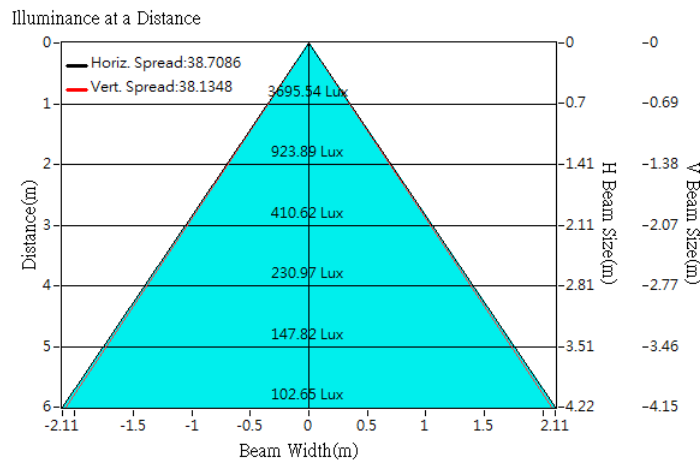

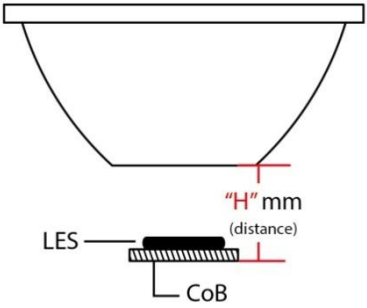

## Optical Characteristics

Model Number	CKO-CH17-060033-0205	<p>"H" definition</p> 
LED	<b>Fortimo SLM 1205 L15 G7N</b>	
LES / LED Size	Φ 14.5 mm	
FWHM (D50)	40°	
Field Angle (D10)	72°	
H (distance)	3.65mm	
Dimension	Φ =60 mm, Thickness=32.6 mm	
Luminous Flux	2136 lm      Measured @ 15.4 W	
Material	PC / UL94V2	

## cd/klm

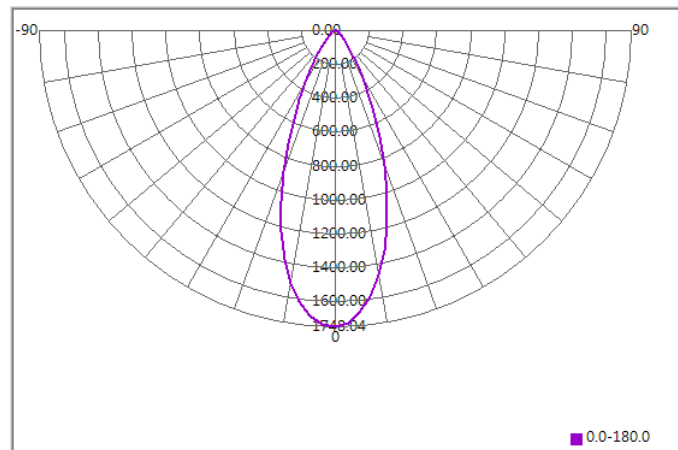

## Illuminance At Distances

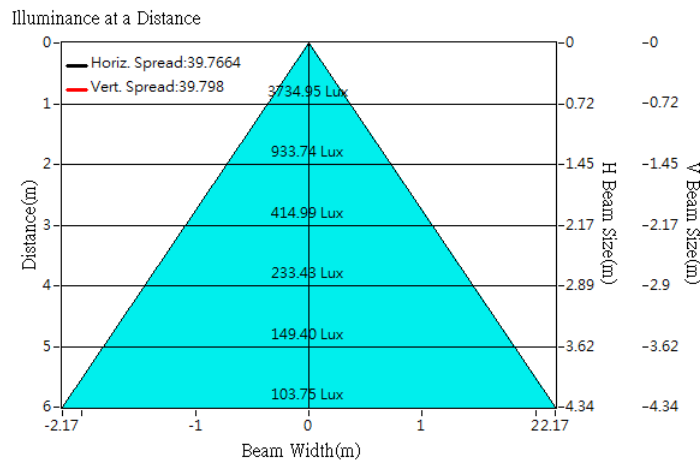



## Optical Characteristics

Model Number	CKO-CH17-060033-0205		<p>"H" definition</p> <p>LES CoB</p>
LED	Fortimo SLM 1206 L15 G7N		
LES / LED Size	Φ 14.5 mm		
FWHM (D50)	40°		
Field Angle (D10)	74°		
H (distance)	3.65mm		
Dimension	Φ =60 mm, Thickness=32.6 mm		
Luminous Flux	2563 lm	Measured @ 18.5 W	
Material	PC / UL94V2		

## cd/klm

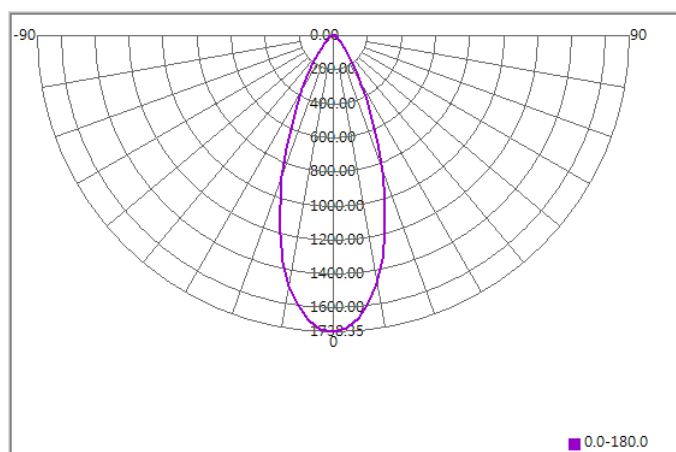

## Illuminance At Distances

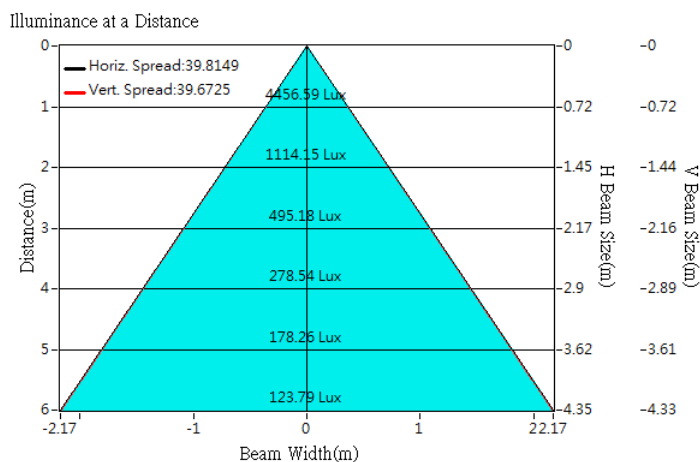



## Optical Characteristics

Model Number	CKO-CH17-060033-0205	<p>"H" definition</p>
LED	<b>Fortimo SLM 1208 L15 G7N</b>	
LES / LED Size	Φ 14.5 mm	
FWHM (D50)	40°	
Field Angle (D10)	74°	
H (distance)	3.65mm	
Dimension	Φ =60 mm, Thickness=32.6 mm	
Luminous Flux	3548 lm	
Material	PC / UL94V2	

## cd/klm

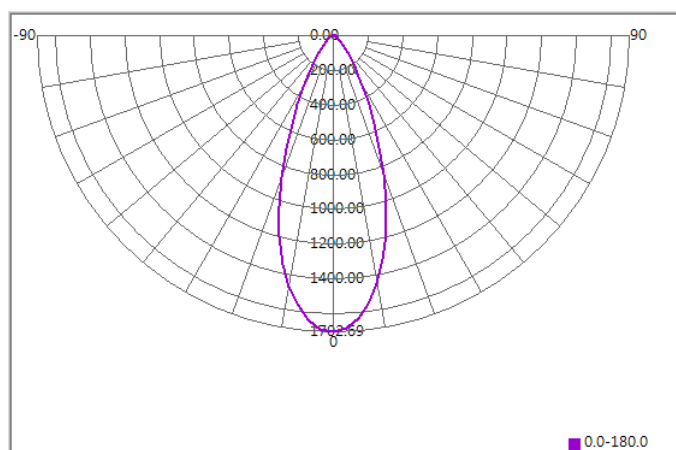

## Illuminance At Distances

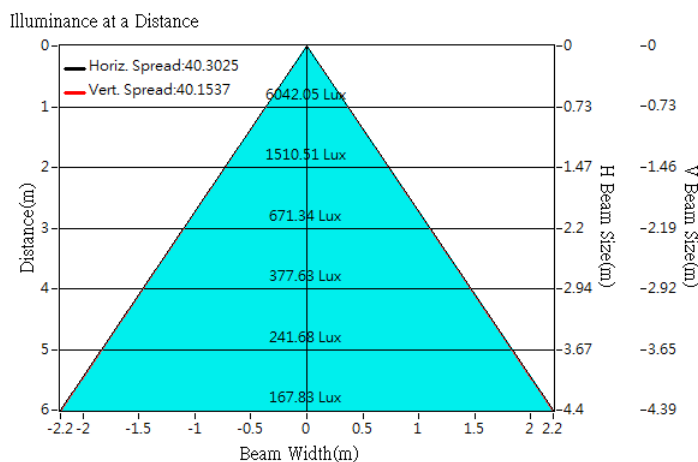

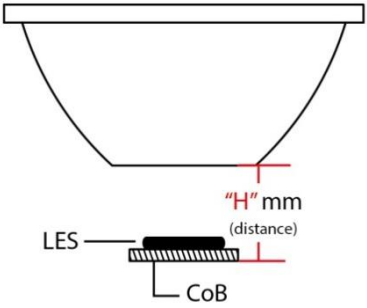

## Optical Characteristics

Model Number	CKO-CH17-060033-0205		<p>"H" definition</p> 
LED	Fortimo SLM 1210 L15 G7N		
LES / LED Size	Φ 14.5 mm		
FWHM (D50)	40°		
Field Angle (D10)	74°		
H (distance)	3.65mm		
Dimension	Φ =60 mm, Thickness=32.6 mm		
Luminous Flux	4084 lm	Measured @ 31.0 W	
Material	PC / UL94V2		

## cd/klm

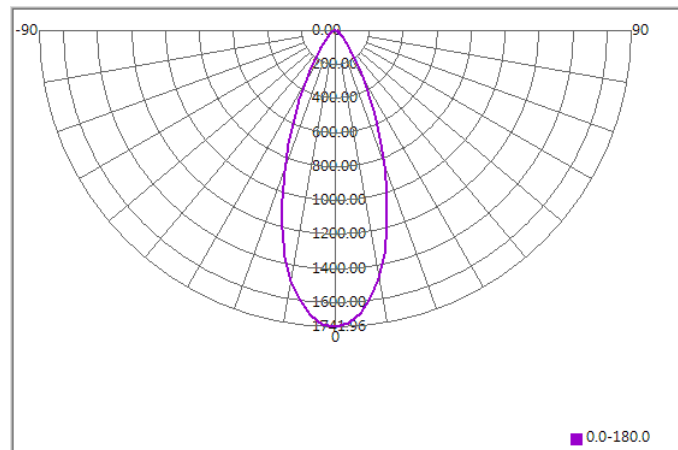

## Illuminance At Distances

