



Product Model Number

CKO-CH19-030015-2503

✓ Model Number Definitions

CKO-XXXX-XXXXXX-XXXX



- A. Chun Kuang Optics Corp. Product
- B. Product Type: product abbreviation
Ex:
CH→CoB High Intensity
CC→CoB Compact
CS→Soft Shading for CoB LED
HC→Holder for CoB LED

- C. Identity Code
- D. Lens / Fixture Size
Ex: 075026=Φ75mm / Thickness=26mm (round up)
- E. Serial Numbers

The lens datasheet is applicable for **Citizen LED**, that manufactured by Chun Kuang Optics Corp.

✓ Dimensions (mm) : Φ30 x 15

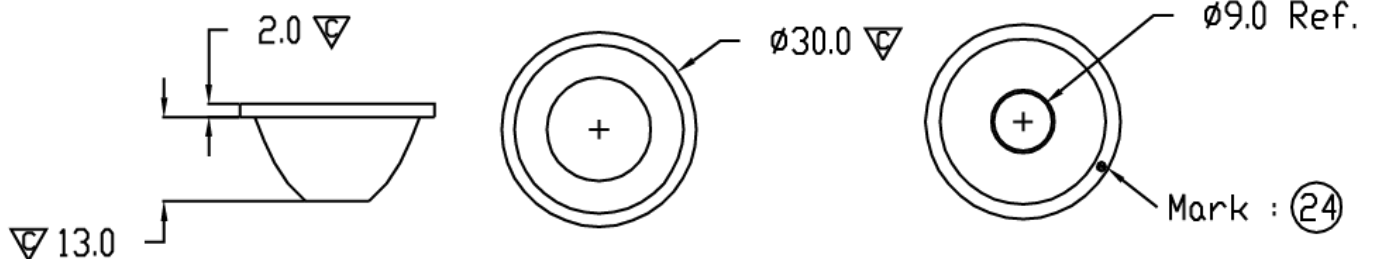

▽:Critical Dimension

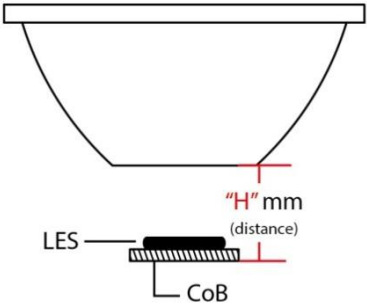

Optical Characteristics

Model Number	CKO-CH19-030015-2503		<p>"H" definition</p> 
LED	CLU 7A2		
LES / LED Size	Φ 4.2 mm		
FWHM (D50)	21°		
Field Angle (D10)	42°		
H (distance)	2.5 mm		
Dimension	Φ =30mm, Thickness= 15mm		
Luminous Flux	531 lm	Measured @ 6.8 W	
Material	PC / UL94V2		

cd/klm

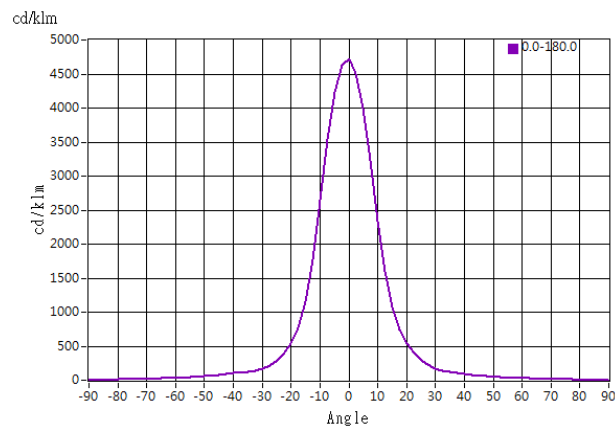

Illuminance At Distances

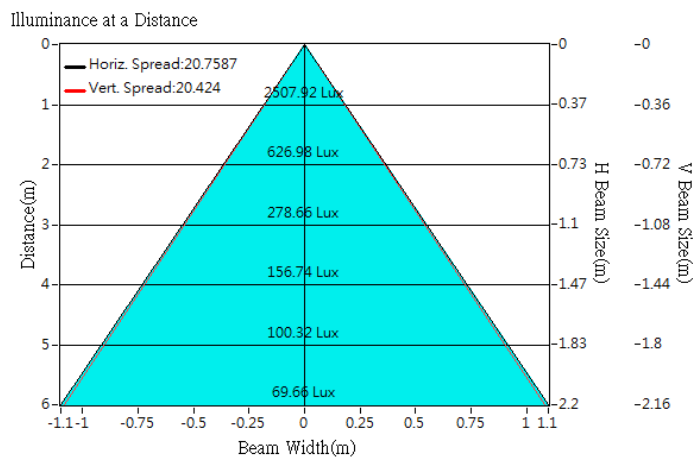



Optical Characteristics

Model Number	CKO-CH19-030015-2503		<p>"H" definition</p>
LED	CLU 700		
LES / LED Size	Φ 6 mm		
FWHM (D50)	25°		
Field Angle (D10)	51°		
H (distance)	2.5 mm		
Dimension	Φ =30mm, Thickness= 15mm		
Luminous Flux	1253 lm	Measured @ 14.3 W	
Material	PC / UL94V2		

cd/klm

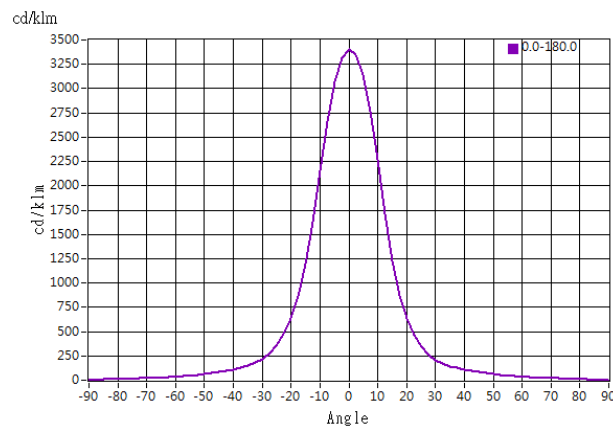

Illuminance At Distances

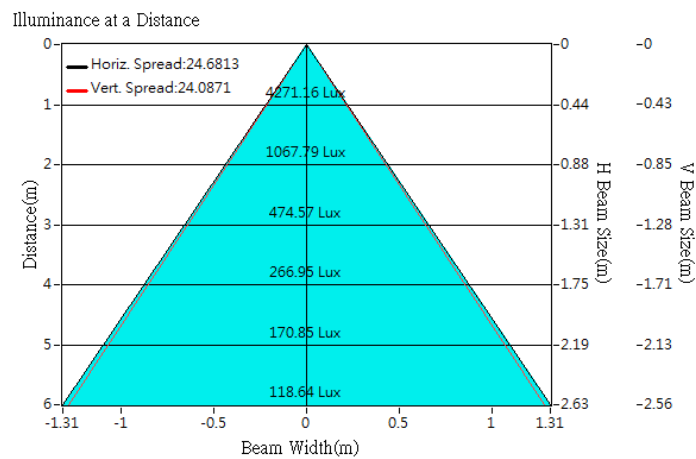



Optical Characteristics

Model Number	CKO-CH19-030015-2503		<p>"H" definition</p>
LED	CLU 701		
LES / LED Size	Φ 6 mm		
FWHM (D50)	24°		
Field Angle (D10)	50°		
H (distance)	2.5 mm		
Dimension	Φ =30mm, Thickness= 15mm		
Luminous Flux	974 lm	Measured @ 10.8 W	
Material	PC / UL94V2		

cd/klm

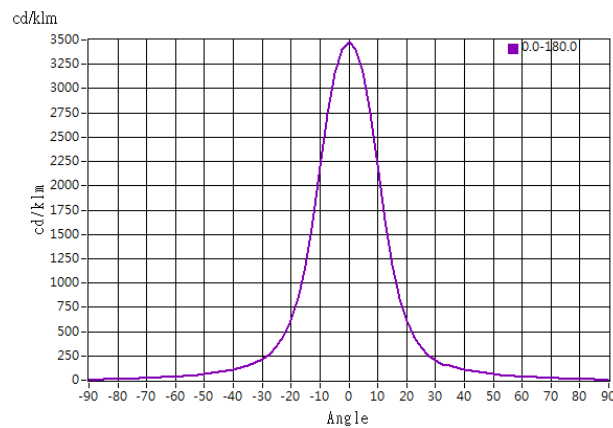

Illuminance At Distances

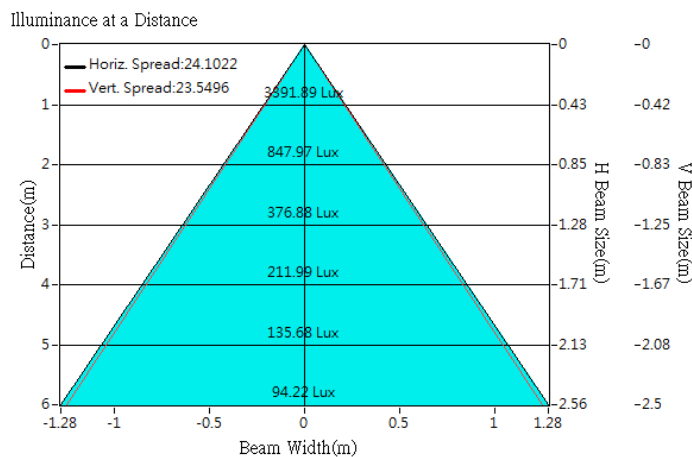



Optical Characteristics

Model Number	CKO-CH19-030015-2503		<p>"H" definition</p>
LED	CLU 711		
LES / LED Size	Φ 8.5 mm		
FWHM (D50)	31°		
Field Angle (D10)	65°		
H (distance)	2.5 mm		
Dimension	Φ =30mm, Thickness=15mm		
Luminous Flux	2515 lm	Measured @ 25.6 W	
Material	PC / UL94V2		

cd/klm

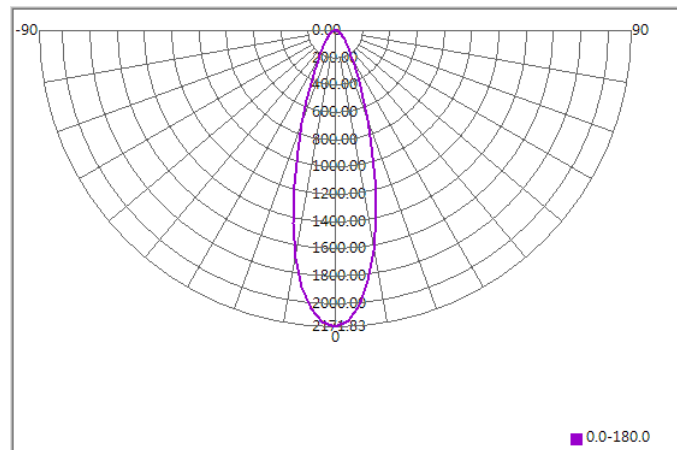

Illuminance At Distances

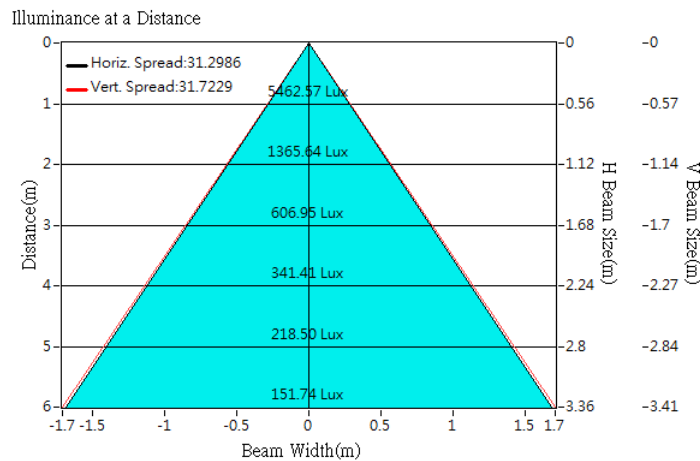



Optical Characteristics

Model Number	CKO-CH19-030015-2503		<p>"H" definition</p>
LED	CLU 710		
LES / LED Size	Φ 8.5 mm		
FWHM (D50)	31°		
Field Angle (D10)	65°		
H (distance)	2.5 mm		
Dimension	Φ =30mm, Thickness=15mm		
Luminous Flux	2266 lm	Measured @ 26.4 W	
Material	PC / UL94V2		

cd/klm

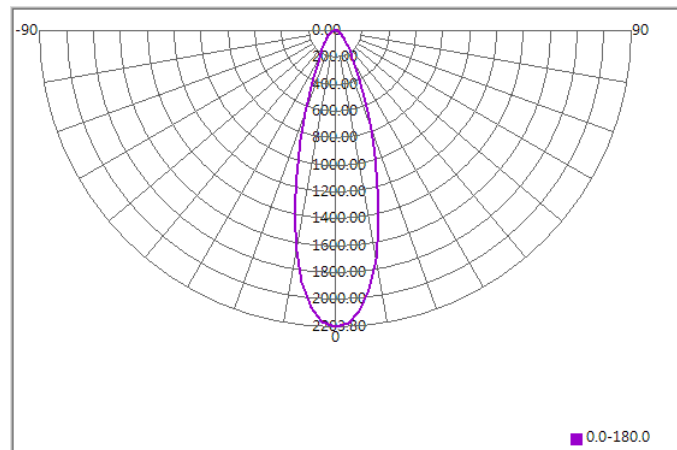

Illuminance At Distances

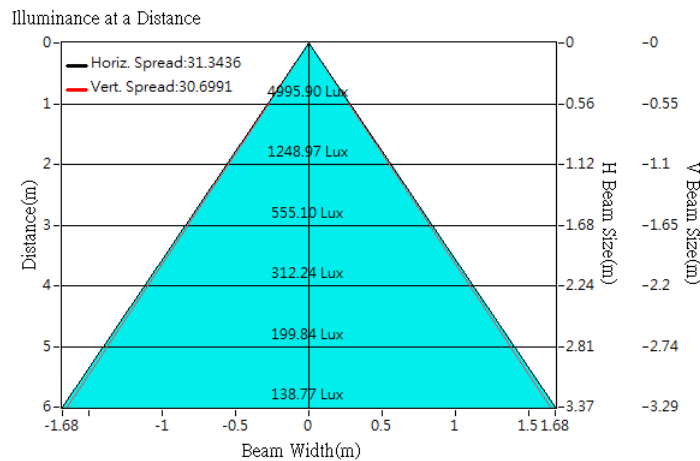



Optical Characteristics

Model Number	CKO-CH19-030015-2503		<p>"H" definition</p>
LED	CLU 028		
LES / LED Size	Φ 9.8 mm		
FWHM (D50)	33°		
Field Angle (D10)	72°		
H (distance)	2.5 mm		
Dimension	Φ =30mm, Thickness=15mm		
Luminous Flux	1428 lm	Measured @ 12.6 W	
Material	PC / UL94V2		

cd/klm

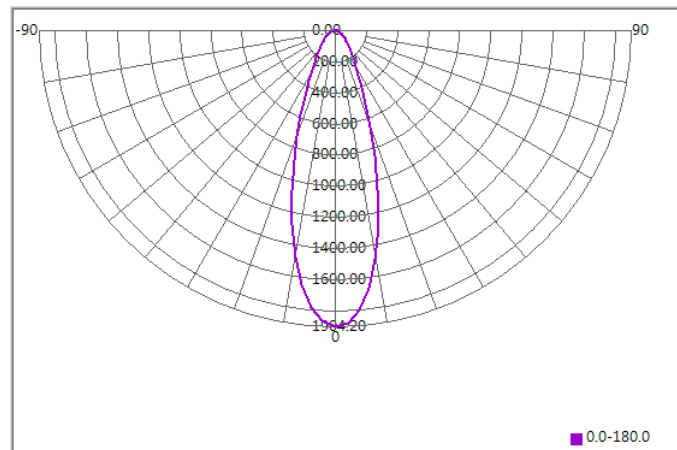

Illuminance At Distances

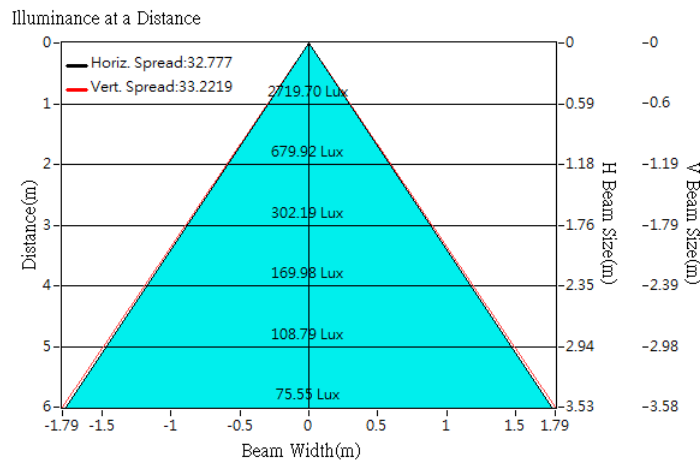



Optical Characteristics

Model Number	CKO-CH19-030015-2503		<p>"H" definition</p> <p>LES CoB "H" mm (distance)</p>
LED	CLU 026		
LES / LED Size	Φ 9.8 mm		
FWHM (D50)	34°		
Field Angle (D10)	74°		
H (distance)	2.5 mm		
Dimension	Φ =30mm, Thickness=15mm		
Luminous Flux	1316 lm	Measured @ 12.5 W	
Material	PC / UL94V2		

cd/klm

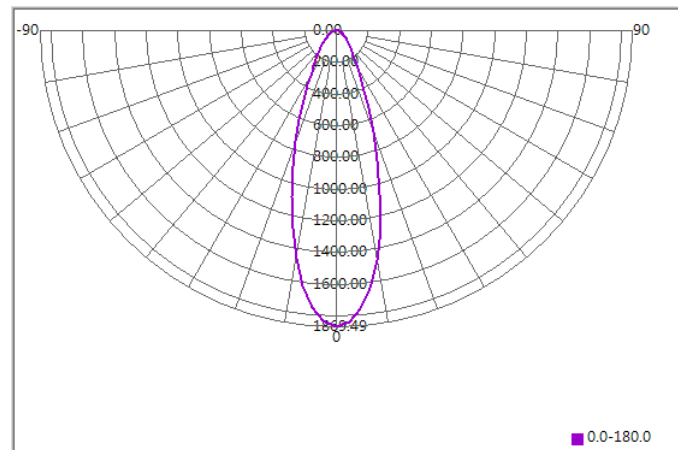

Illuminance At Distances

