



Product Model Number

CKO-CH19-035018-2801

✓ Model Number Definitions

CKO-XXXX-XXXXXX-XXXX



- A. Chun Kuang Optics Corp. Product
- B. Product Type: product abbreviation
Ex:
CH→CoB High Intensity
CC→CoB Compact
CS→Soft Shading for CoB LED
HC→Holder for CoB LED

- C. Identity Code
- D. Lens / Fixture Size
Ex: 075026=Φ75mm / Thickness=26mm (round up)
- E. Serial Numbers

The lens datasheet is applicable for **Luminus LED**, that manufactured by Chun Kuang Optics Corp.

✓ Dimensions (mm) : Φ35 x 17.4

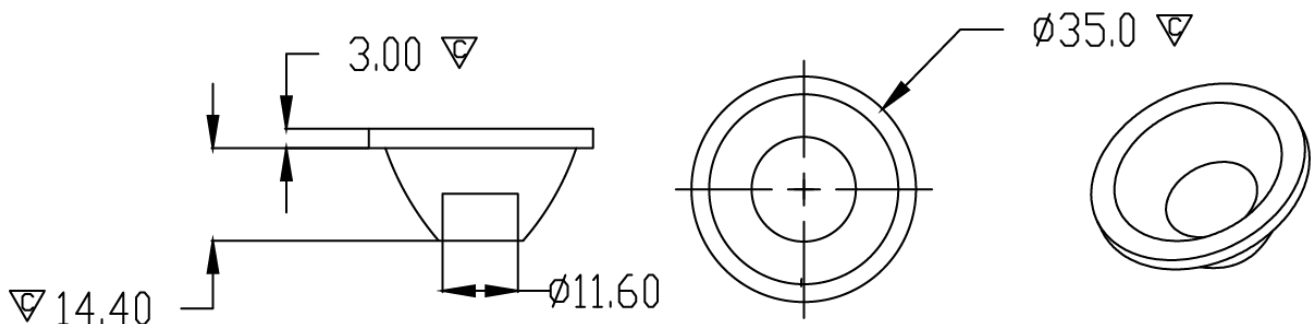

▽:Critical Dimension



Optical Characteristics

Model Number	CKO-CH19-035018-2801	<p>"H" definition</p>
LED	CXM-3-AC40	
LES / LED Size	Φ 3.5 mm	
FWHM (D50)	13°	
Field Angle (D10)	28°	
H (distance)	2.5 mm	
Dimension	Φ =35mm, Thickness=17.4mm	
Luminous Flux	298 lm	
Material	PC / UL94V2	

cd/klm

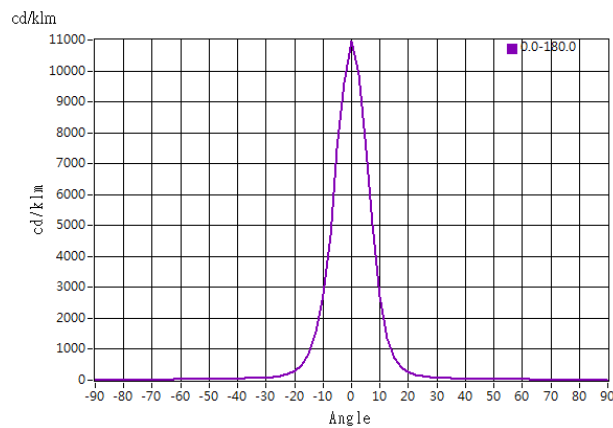

Illuminance At Distances

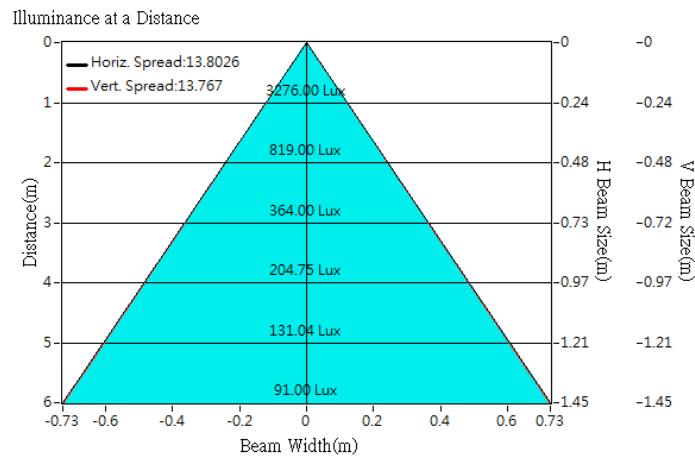



Optical Characteristics

Model Number	CKO-CH19-035018-2801	<p>"H" definition</p>
LED	CXM-4-AC40	
LES / LED Size	Φ 4.5 mm	
FWHM (D50)	16°	
Field Angle (D10)	32°	
H (distance)	2.5 mm	
Dimension	Φ =35mm, Thickness=17.4mm	
Luminous Flux	456 lm	
Material	PC / UL94V2	

cd/klm

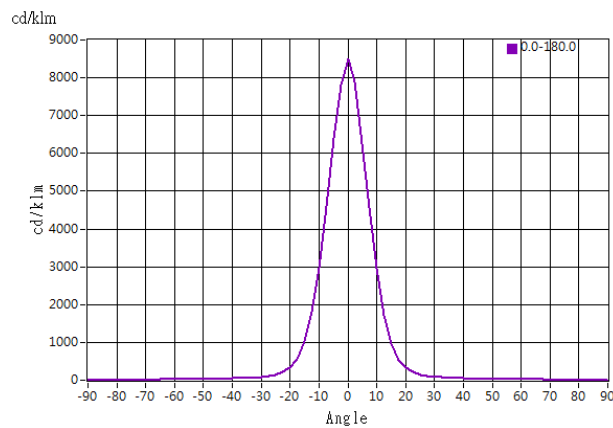

Illuminance At Distances

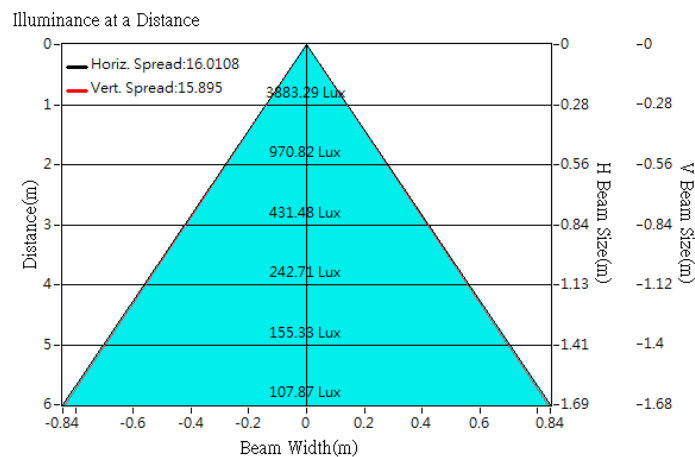



Optical Characteristics

Model Number	CKO-CH19-035018-2801		<p>"H" definition</p>
LED	CXM-6-AC40		
LES / LED Size	Φ 6.3 mm		
FWHM (D50)	22°		
Field Angle (D10)	43°		
H (distance)	2.5 mm		
Dimension	Φ =35mm, Thickness=17.4mm		
Luminous Flux	719 lm	Measured @ 5.0 W	
Material	PC / UL94V2		

cd/klm

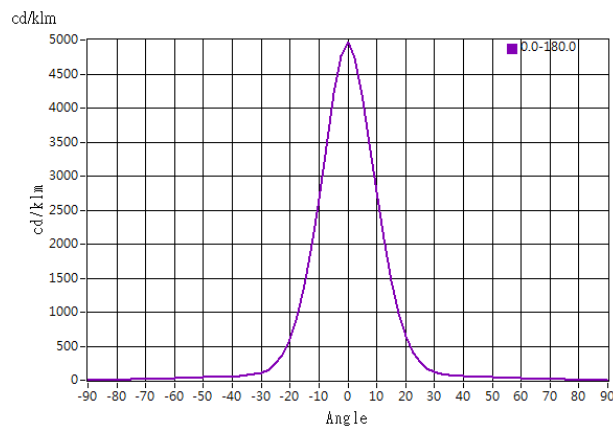

Illuminance At Distances

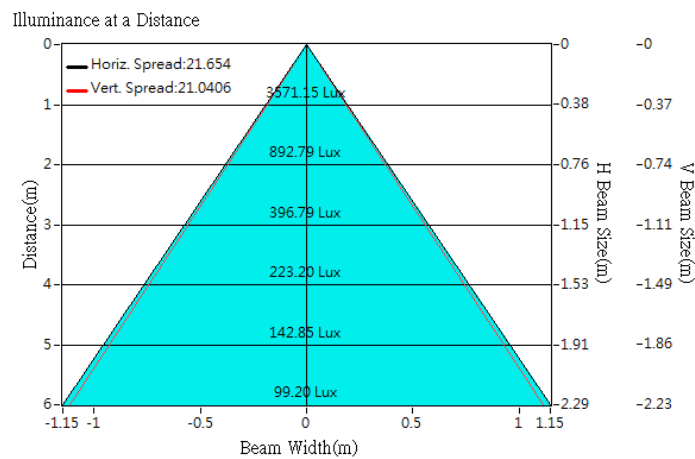



Optical Characteristics

Model Number	CKO-CH19-035018-2801		<p>"H" definition</p>
LED	CXM-9-AC30		
LES / LED Size	Φ 9.6 mm		
FWHM (D50)	27°		
Field Angle (D10)	54°		
H (distance)	2.5 mm		
Dimension	Φ =35mm, Thickness=17.4mm		
Luminous Flux	1247 lm	Measured @ 12.1 W	
Material	PC / UL94V2		

cd/klm

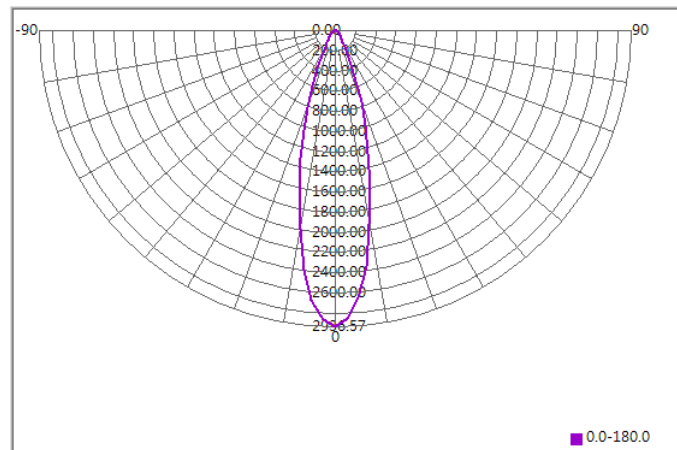

Illuminance At Distances

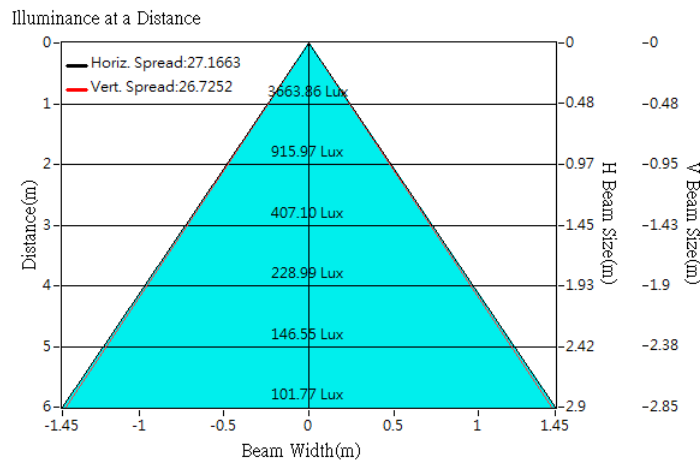



Optical Characteristics

Model Number	CKO-CH19-035018-2801		<p>"H" definition</p> <p>LES CoB</p>
LED	CXM-9-AC40		
LES / LED Size	Φ 9.8 mm		
FWHM (D50)	28°		
Field Angle (D10)	57°		
H (distance)	2.5 mm		
Dimension	Φ =35mm, Thickness=17.4mm		
Luminous Flux	1338 lm	Measured @ 12.1 W	
Material	PC / UL94V2		

cd/klm

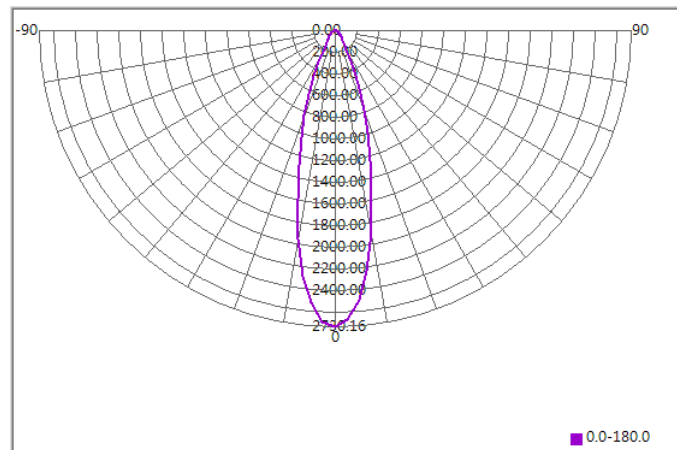

Illuminance At Distances

