



Product Model Number

CKO-CH19-035018-2860

✓ Model Number Definitions

CKO-XXXX-XXXXXX-XXXX



- A. Chun Kuang Optics Corp. Product
- B. Product Type: product abbreviation
Ex:
CH→CoB High Intensity
CC→CoB Compact
CS→Soft Shading for CoB LED
HC→Holder for CoB LED

- C. Identity Code
- D. Lens / Fixture Size
Ex: 075026=Φ75mm / Thickness=26mm (round up)
- E. Serial Numbers



The lens datasheet is applicable for **Cree LED**, that manufactured by Chun Kuang Optics Corp.

✓ Dimensions (mm) : Φ35 x 17.4



▽:Critical Dimension

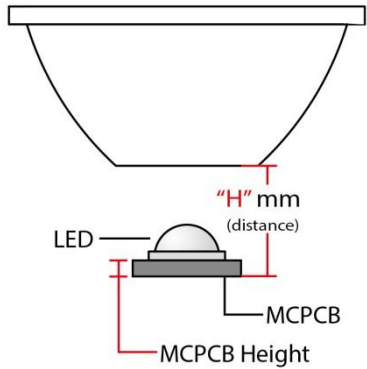

Optical Characteristics

| | | | |
|-------------------|---------------------------|------------------|--|
| Model Number | CKO-CH19-035018-2860 | | <p>"H" definition</p>  |
| LED | XD-16 4IN1 | | |
| LES / LED Size | 1.6 x 1.6 | | |
| FWHM (D50) | 66° | | |
| Field Angle (D10) | 95° | | |
| H (distance) | 2.5 mm | | |
| MCPCB Height | 1.1 mm | | |
| Dimension | Φ =30 mm, Thickness=15 mm | | |
| Luminous Flux | 366 lm | Measured @ 3.2 W | |
| Material | PC / UL94V2 | | |

cd/klm

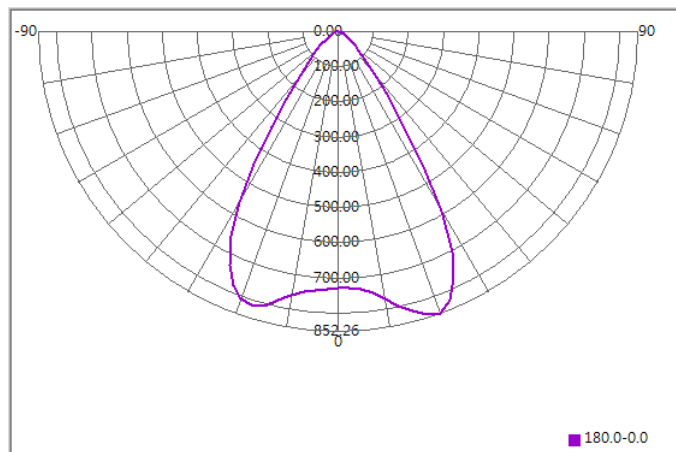

Illuminance At Distances

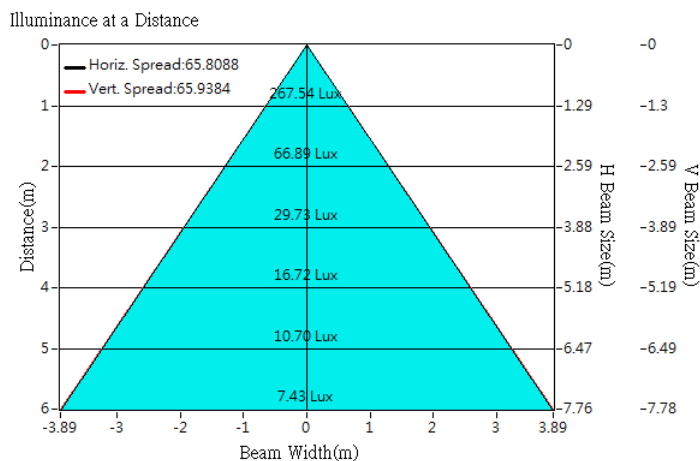

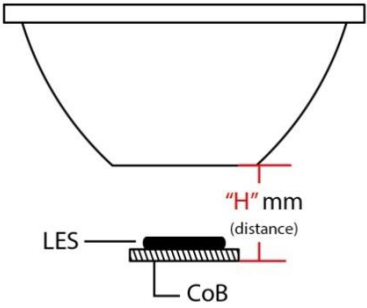

Optical Characteristics

| | | | |
|-------------------|---------------------------|------------------|--|
| Model Number | CKO-CH19-035018-2860 | | <p>"H" definition</p>  |
| LED | CMA1303 | | |
| LES / LED Size | Φ 4.5 mm | | |
| FWHM (D50) | 58° | | |
| Field Angle (D10) | 82° | | |
| H (distance) | 2.5 mm | | |
| Dimension | Φ =35mm, Thickness=17.4mm | | |
| Luminous Flux | 765 lm | Measured @ 6.7 W | |
| Material | PC / UL94V2 | | |

cd/klm

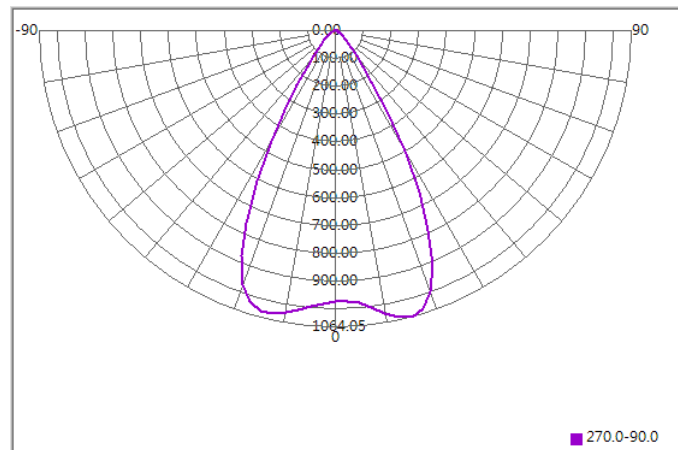

Illuminance At Distances

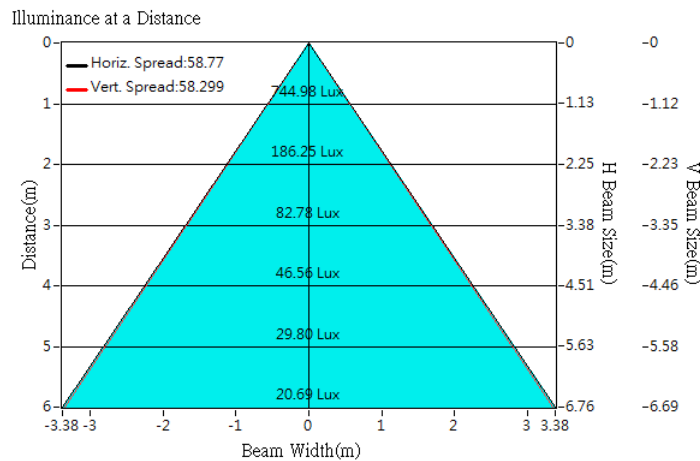



Optical Characteristics

| | | | |
|-------------------|---------------------------|------------------|--|
| Model Number | CKO-CH19-035018-2860 | | <p>"H" definition</p> <p>LES CoB</p> |
| LED | CXA1304 | | |
| LES / LED Size | Φ 6 mm | | |
| FWHM (D50) | 62° | | |
| Field Angle (D10) | 88° | | |
| H (distance) | 2.5 mm | | |
| Dimension | Φ =35mm, Thickness=17.4mm | | |
| Luminous Flux | 396 lm | Measured @ 4.2 W | |
| Material | PC / UL94V2 | | |

cd/klm

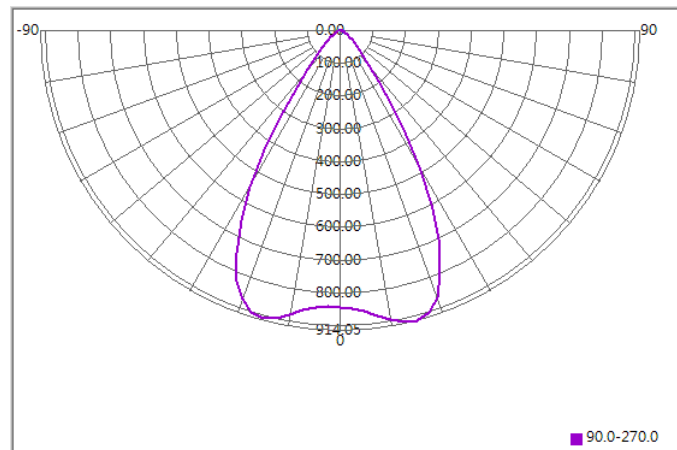

Illuminance At Distances

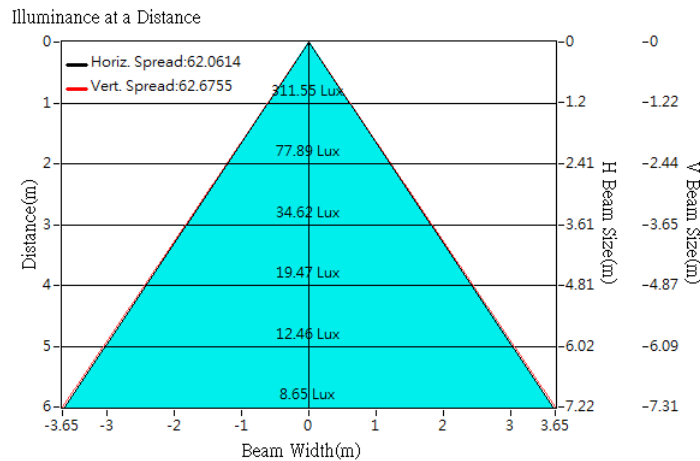



Optical Characteristics

| | | | |
|-------------------|---------------------------|------------------|--|
| Model Number | CKO-CH19-035018-2860 | | <p>"H" definition</p> <p>LES CoB</p> |
| LED | CXB1304 | | |
| LES / LED Size | Φ 6 mm | | |
| FWHM (D50) | 62° | | |
| Field Angle (D10) | 88° | | |
| H (distance) | 2.5 mm | | |
| Dimension | Φ =35mm, Thickness=17.4mm | | |
| Luminous Flux | 414 lm | Measured @ 3.5 W | |
| Material | PC / UL94V2 | | |

cd/klm

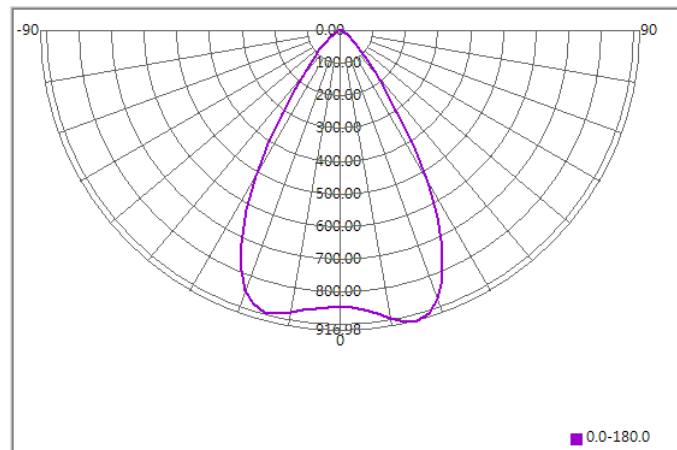

Illuminance At Distances

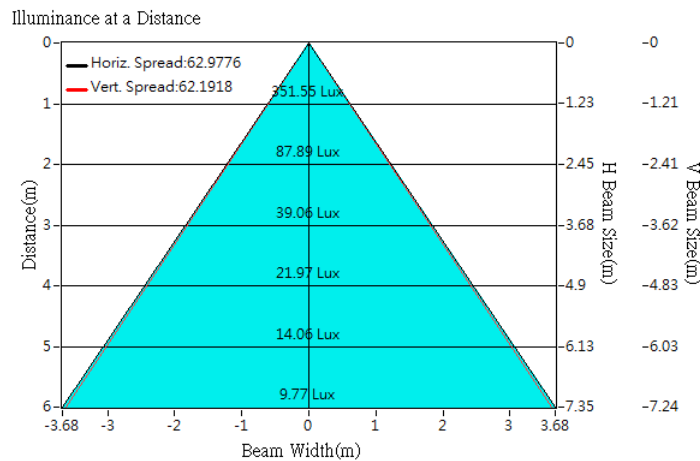



Optical Characteristics

| | | | |
|-------------------|---------------------------|-------------------|-----------------------|
| Model Number | CKO-CH19-035018-2860 | | <p>"H" definition</p> |
| LED | CXB1310 | | |
| LES / LED Size | Φ 6 mm | | |
| FWHM (D50) | 56° | | |
| Field Angle (D10) | 85° | | |
| H (distance) | 2.5 mm | | |
| Dimension | Φ =35mm, Thickness=17.4mm | | |
| Luminous Flux | 1424 lm | Measured @ 11.9 W | |
| Material | PC / UL94V2 | | |

cd/klm

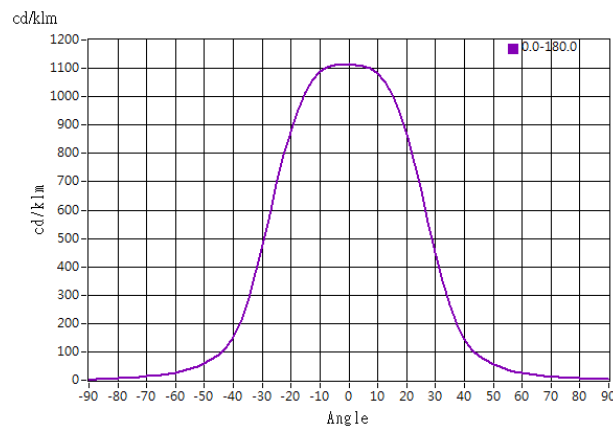

Illuminance At Distances

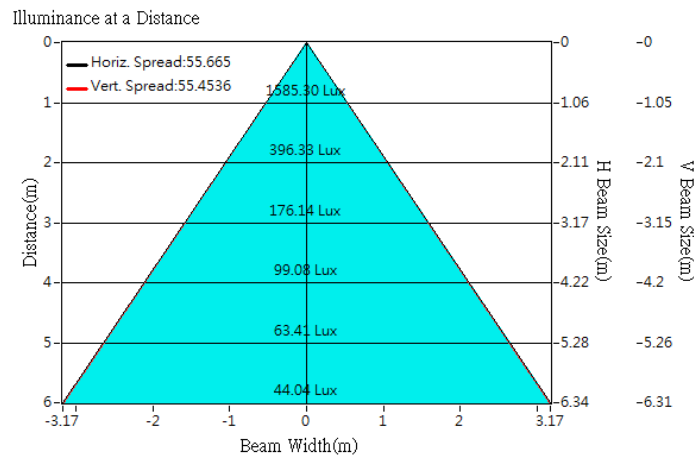

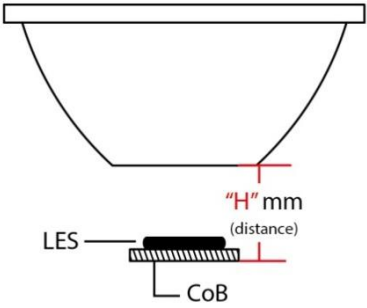

Optical Characteristics

| | | | |
|-------------------|-------------------------|------------------|--|
| Model Number | CKO-CH19-035018-2860 | | <p>"H" definition</p>  |
| LED | CXA1507 | | |
| LES / LED Size | Φ 6 mm | | |
| FWHM (D50) | 56° | | |
| Field Angle (D10) | 86° | | |
| H (distance) | 2.5 mm | | |
| Dimension | Φ =30mm, Thickness=15mm | | |
| Luminous Flux | 692 lm | Measured @ 7.6 W | |
| Material | PC / UL94V2 | | |

cd/klm

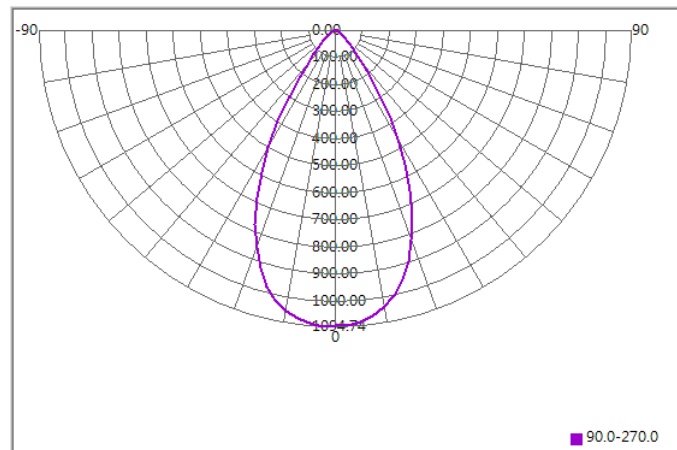

Illuminance At Distances

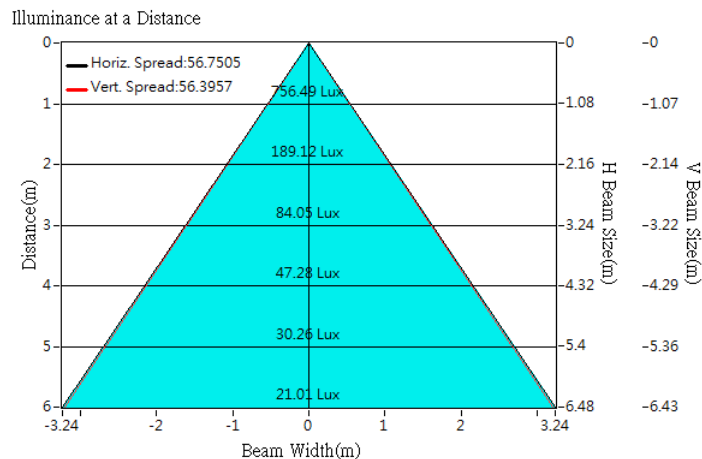



Optical Characteristics

| | | | |
|-------------------|-------------------------|------------------|--|
| Model Number | CKO-CH19-035018-2860 | | <p>"H" definition</p> <p>LES CoB "H" mm (distance)</p> |
| LED | CXB1507 | | |
| LES / LED Size | Φ 6 mm | | |
| FWHM (D50) | 60° | | |
| Field Angle (D10) | 91° | | |
| H (distance) | 2.5 mm | | |
| Dimension | Φ =30mm, Thickness=15mm | | |
| Luminous Flux | 841 lm | Measured @ 7.2 W | |
| Material | PC / UL94V2 | | |

cd/klm

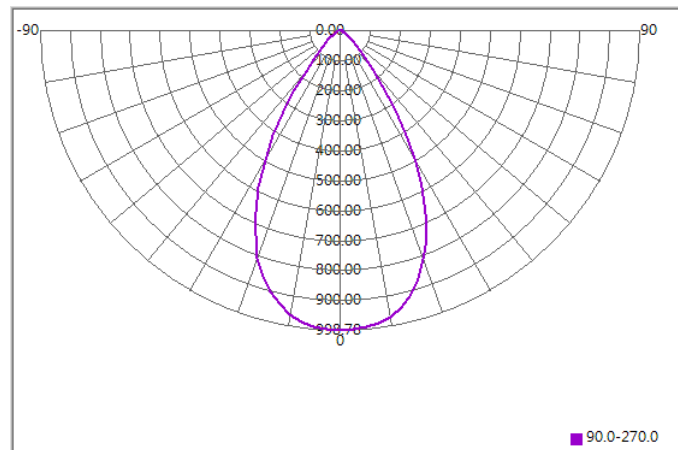

Illuminance At Distances

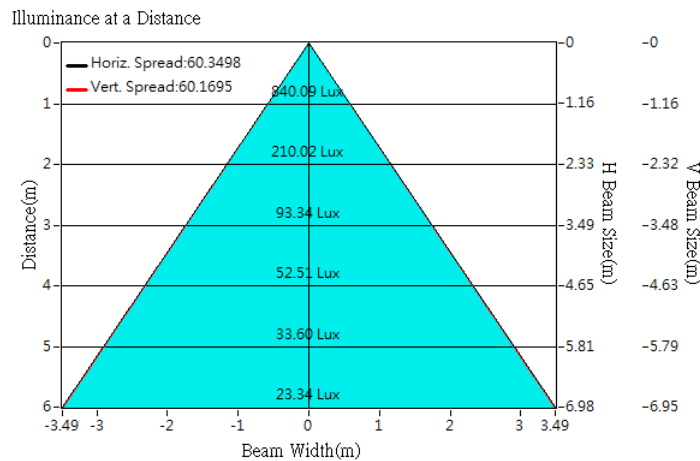

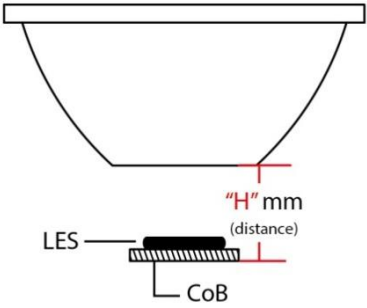

Optical Characteristics

| | | | |
|-------------------|-------------------------|------------------|--|
| Model Number | CKO-CH19-035018-2860 | | <p>"H" definition</p>  |
| LED | CXA1510 | | |
| LES / LED Size | Φ 6 mm | | |
| FWHM (D50) | 58° | | |
| Field Angle (D10) | 88° | | |
| H (distance) | 2.5 mm | | |
| Dimension | Φ =30mm, Thickness=15mm | | |
| Luminous Flux | 1015 lm | Measured @ 9.1 W | |
| Material | PC / UL94V2 | | |

cd/klm

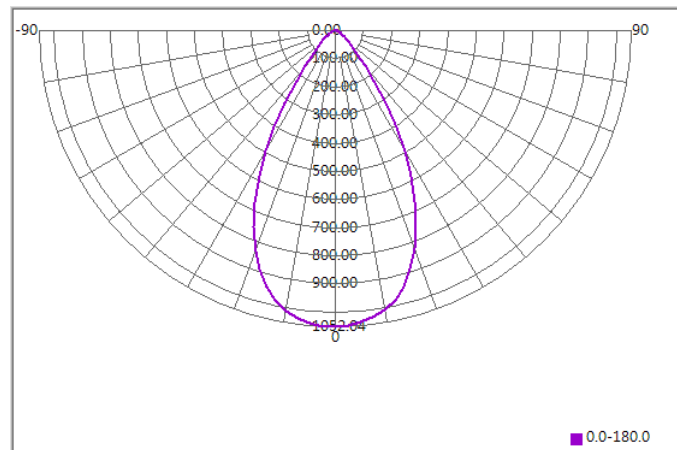

Illuminance At Distances

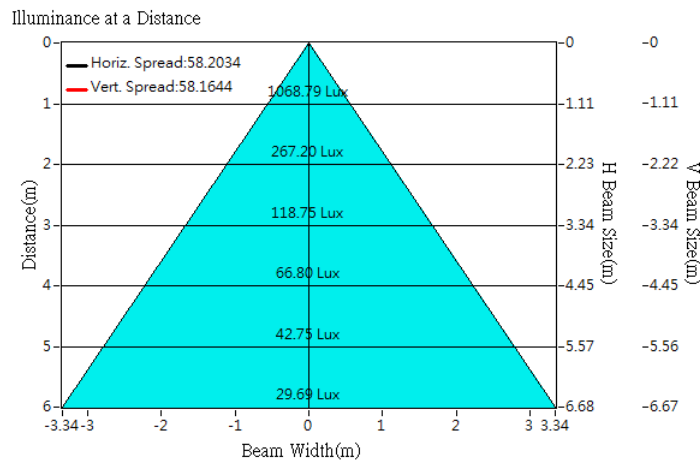



Optical Characteristics

| | | | |
|-------------------|---------------------------|-------------------|--|
| Model Number | CKO-CH19-035018-2860 | | <p>"H" definition</p> <p>LES CoB</p> |
| LED | CXA1512 | | |
| LES / LED Size | Φ 9 mm | | |
| FWHM (D50) | 60° | | |
| Field Angle (D10) | 89° | | |
| H (distance) | 2.5 mm | | |
| Dimension | Φ =35mm, Thickness=17.4mm | | |
| Luminous Flux | 1233 lm | Measured @ 13.2 W | |
| Material | PC / UL94V2 | | |

cd/klm

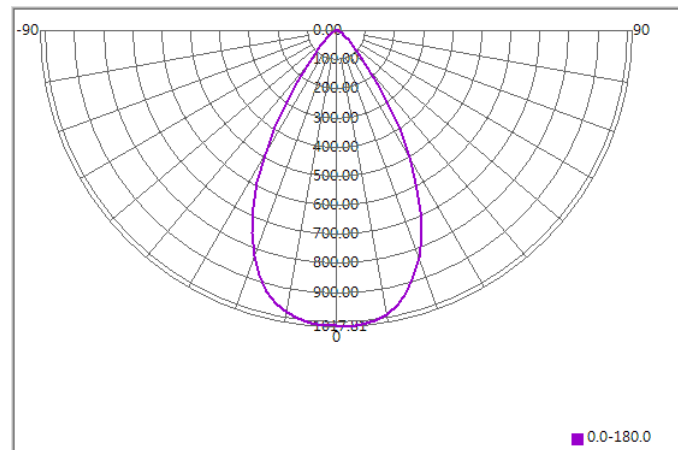

Illuminance At Distances

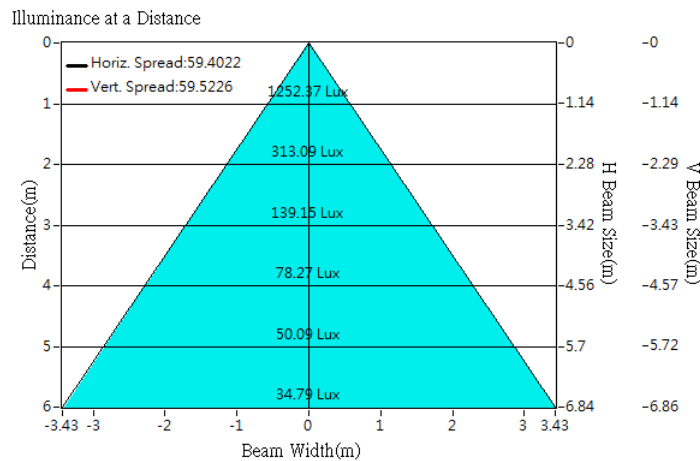



Optical Characteristics

| | | |
|-------------------|---------------------------|-----------------------|
| Model Number | CKO-CH19-035018-2860 | <p>"H" definition</p> |
| LED | CXB1512 | |
| LES / LED Size | Φ 9 mm | |
| FWHM (D50) | 58° | |
| Field Angle (D10) | 86° | |
| H (distance) | 2.5 mm | |
| Dimension | Φ =35mm, Thickness=17.4mm | |
| Luminous Flux | 1457 lm | |
| Material | PC / UL94V2 | |

cd/klm

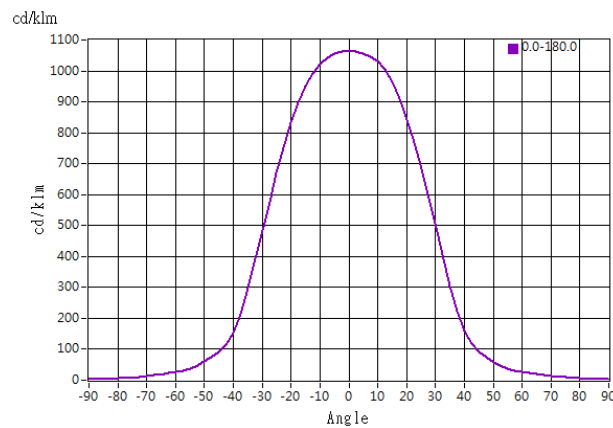

Illuminance At Distances

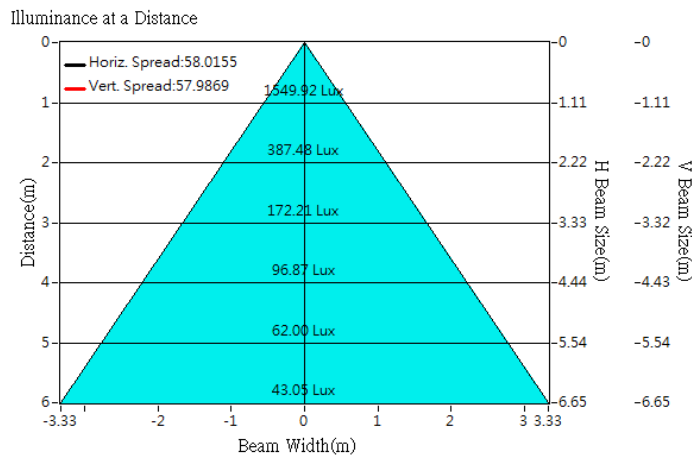



Optical Characteristics

| | | | |
|-------------------|---------------------------|-------------------|-----------------------|
| Model Number | CKO-CH19-035018-2860 | | <p>"H" definition</p> |
| LED | CMA1516 | | |
| LES / LED Size | Φ 9 mm | | |
| FWHM (D50) | 58° | | |
| Field Angle (D10) | 87° | | |
| H (distance) | 2.5 mm | | |
| Dimension | Φ =35mm, Thickness=17.4mm | | |
| Luminous Flux | 1947 lm | Measured @ 15.7 W | |
| Material | PC / UL94V2 | | |

cd/klm

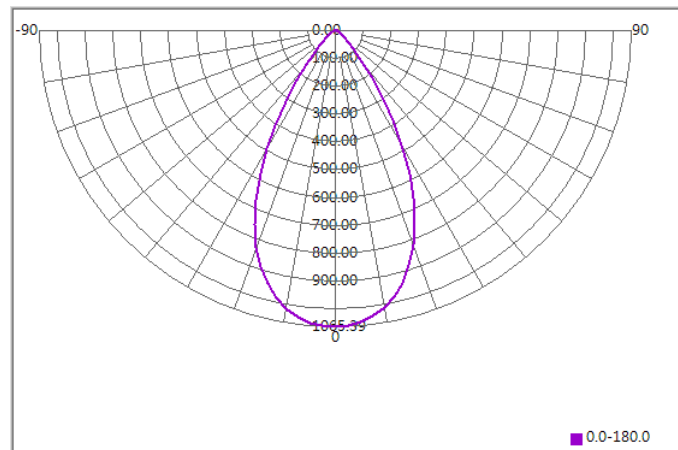

Illuminance At Distances

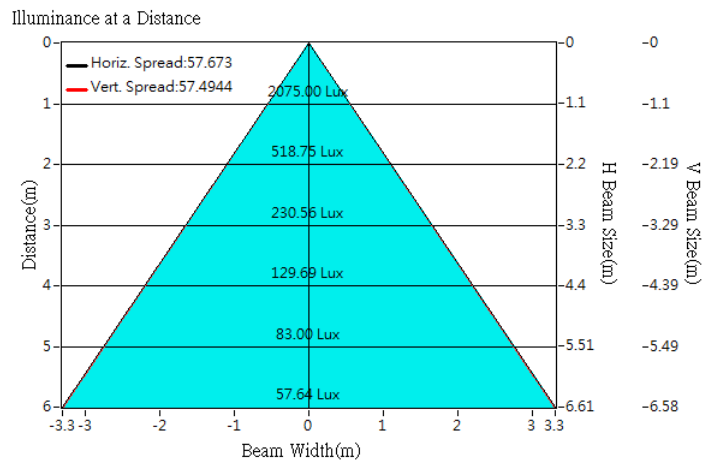



Optical Characteristics

| | | | |
|-------------------|---------------------------|-------------------|-----------------------|
| Model Number | CKO-CH19-035018-2860 | | <p>"H" definition</p> |
| LED | CXB1520 | | |
| LES / LED Size | Φ 9 mm | | |
| FWHM (D50) | 60° | | |
| Field Angle (D10) | 88° | | |
| H (distance) | 2.5 mm | | |
| Dimension | Φ =35mm, Thickness=17.4mm | | |
| Luminous Flux | 2089 lm | Measured @ 16.8 W | |
| Material | PC / UL94V2 | | |

cd/klm

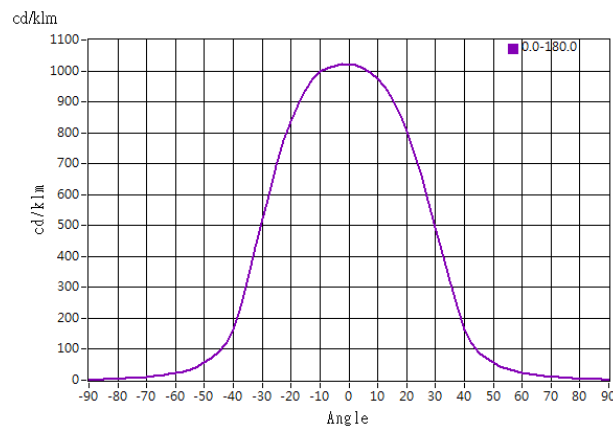

Illuminance At Distances

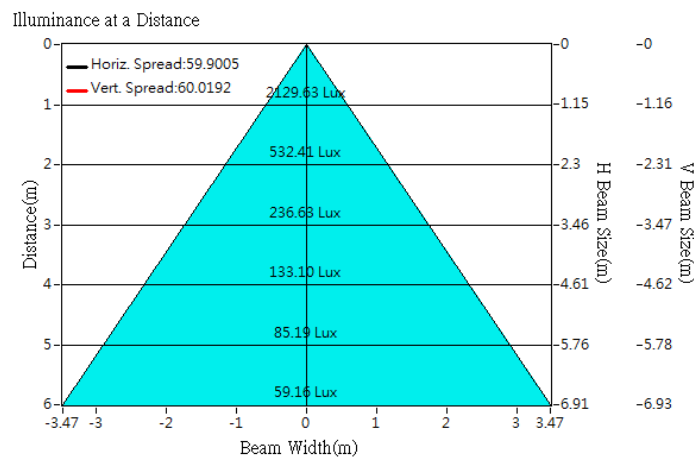



Optical Characteristics

| | | | |
|-------------------|---------------------------|------------------|-----------------------|
| Model Number | CKO-CH19-035018-2860 | | <p>"H" definition</p> |
| LED | CMT1407 | | |
| LES / LED Size | Φ 9.8 mm | | |
| FWHM (D50) | 56° | | |
| Field Angle (D10) | 88° | | |
| H (distance) | 2.5 mm | | |
| Dimension | Φ =35mm, Thickness=17.4mm | | |
| Luminous Flux | 883 lm | Measured @ 7.0 W | |
| Material | PC / UL94V2 | | |

cd/klm

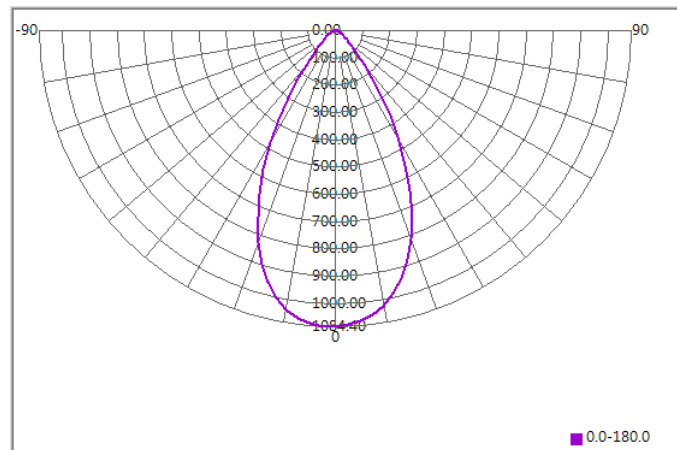

Illuminance At Distances

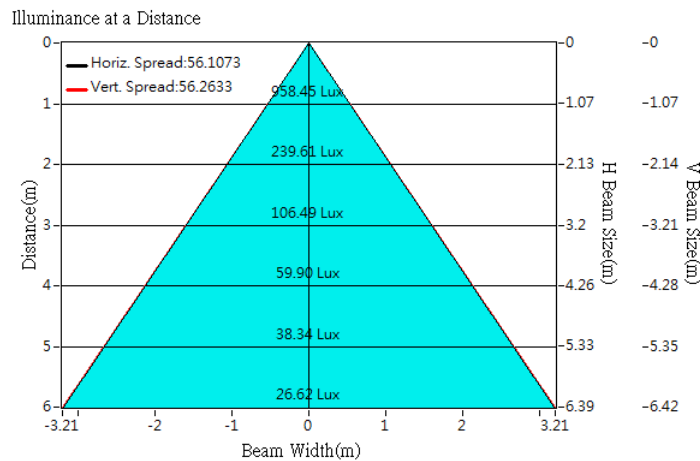



Optical Characteristics

| | | | |
|-------------------|---------------------------|-------------------|-----------------------|
| Model Number | CKO-CH19-035018-2860 | | <p>"H" definition</p> |
| LED | CMT1412 | | |
| LES / LED Size | Φ 9.8 mm | | |
| FWHM (D50) | 56° | | |
| Field Angle (D10) | 84° | | |
| H (distance) | 2.5 mm | | |
| Dimension | Φ =35mm, Thickness=17.4mm | | |
| Luminous Flux | 1566 lm | Measured @ 12.2 W | |
| Material | PC / UL94V2 | | |

cd/klm

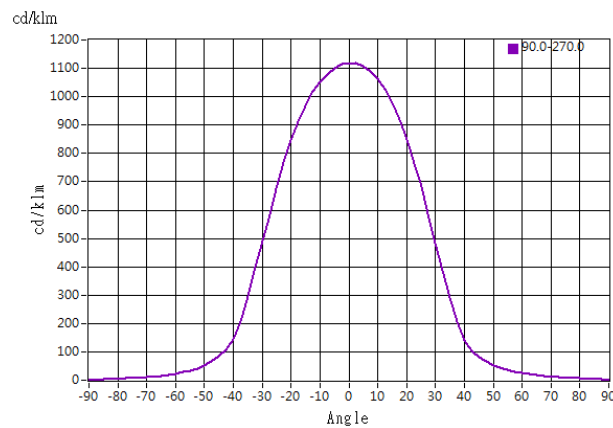

Illuminance At Distances

