



Product Model Number

CKO-CS15-060027-4204

✓ Model Number Definitions

CKO-XXXX-XXXXXX-XXXX



- A. Chun Kuang Optics Corp. Product
- B. Product Type: product abbreviation
Ex:
CH→CoB High Intensity
CC→CoB Compact
CS→Soft Shading for CoB LED
HC→Holder for CoB LED

- C. Identity Code
- D. Lens / Fixture Size
Ex: 075026=Φ75mm / Thickness=26mm (round up)
- C. Serial Numbers

The lens datasheet is applicable for **Citizen LED**, that manufactured by Chun Kuang Optics Corp.

✓ Dimensions (mm) : Φ60 x 26.85

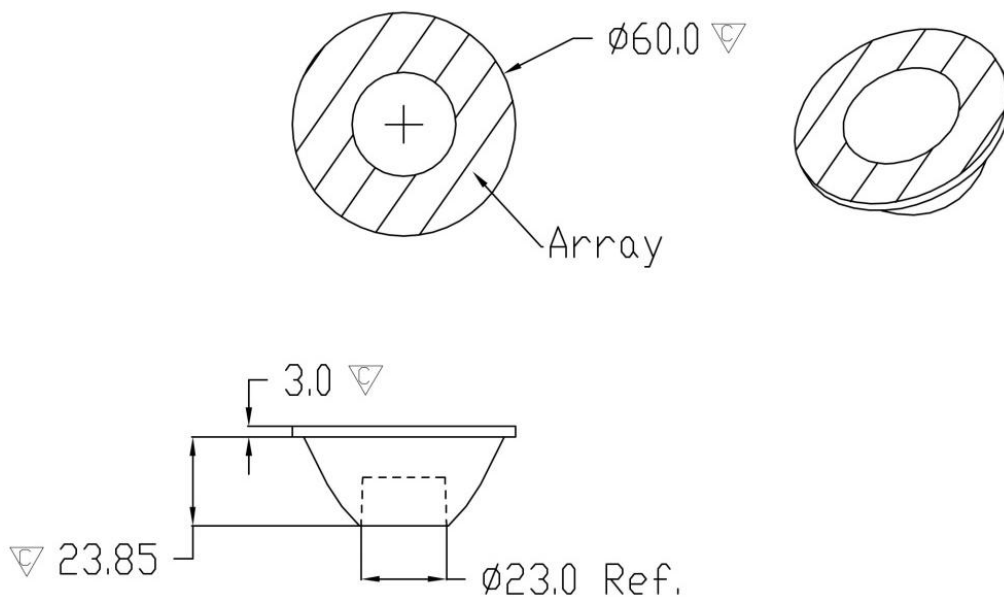

▽:Critical Dimension



Optical Characteristics

Model Number	CKO-CS15-060027-4204		<p>"H" definition</p>
LED	CLU 711		
LES / LED Size	Φ 8.5 mm		
FWHM (D50)	21°		
Field Angle (D10)	44°		
H (distance)	3.65 mm		
Dimension	Φ =60 mm, Thickness=26.85 mm		
Luminous Flux	2742 lm	Measured @ 25.7 W	
Material	PC / UL94V2		

cd/klm

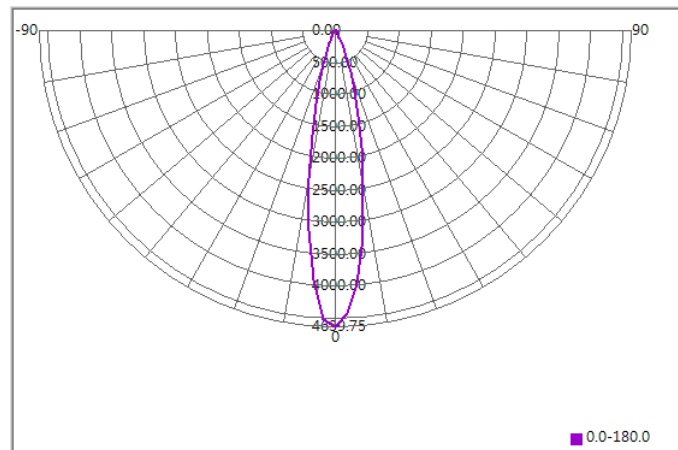

Illuminance At Distances

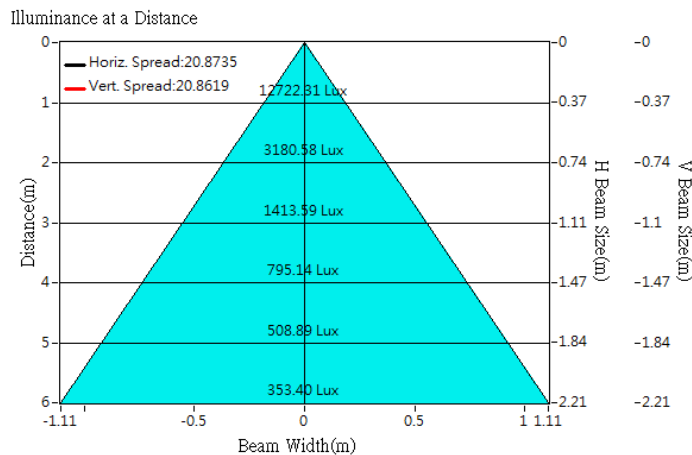



Optical Characteristics

Model Number	CKO-CS15-060027-4204		<p>"H" definition</p>
LED	CLU 710		
LES / LED Size	Φ 8.5 mm		
FWHM (D50)	21°		
Field Angle (D10)	44°		
H (distance)	3.65 mm		
Dimension	Φ =60 mm, Thickness=26.85 mm		
Luminous Flux	2488 lm	Measured @ 26.4 W	
Material	PC / UL94V2		

cd/klm

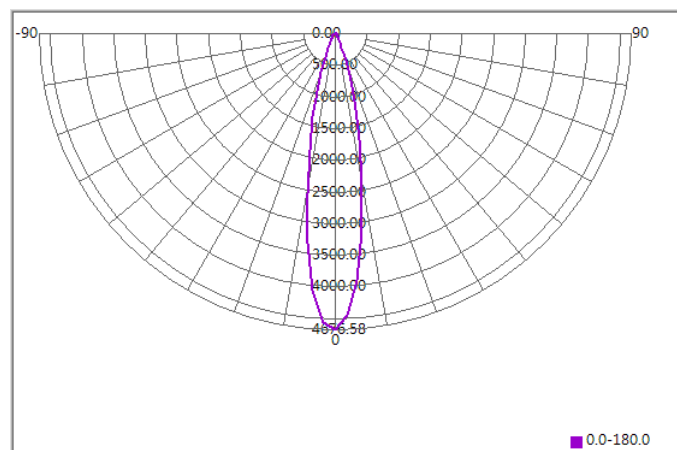

Illuminance At Distances

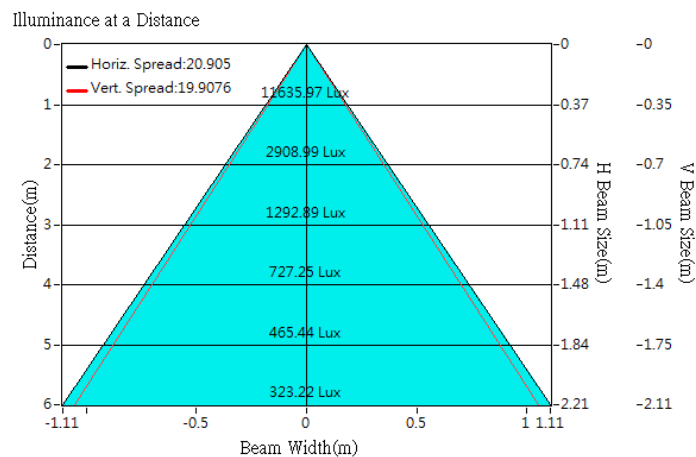



Optical Characteristics

Model Number	CKO-CS15-060027-4204		<p>"H" definition</p>
LED	CLU 028		
LES / LED Size	Φ 9.8 mm		
FWHM (D50)	22°		
Field Angle (D10)	46°		
H (distance)	3.65 mm		
Dimension	Φ =60 mm, Thickness=26.85 mm		
Luminous Flux	1544 lm	Measured @ 12 W	
Material	PC / UL94V2		

cd/klm

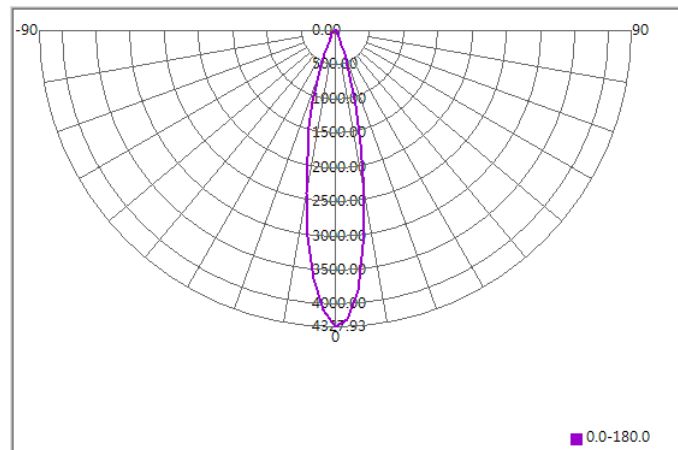

Illuminance At Distances

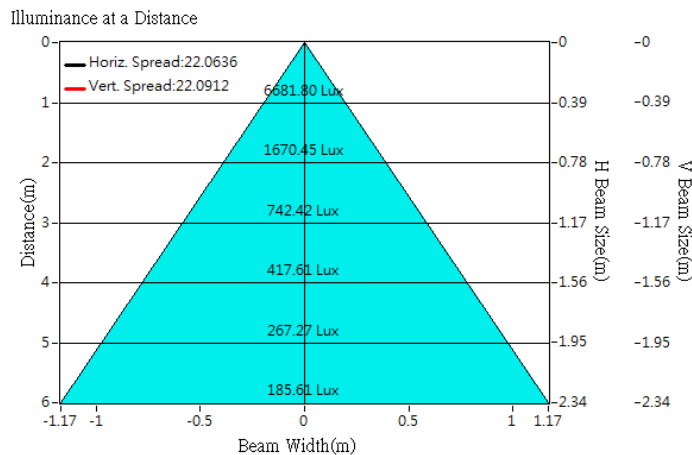



Optical Characteristics

Model Number	CKO-CS15-060027-4204		<p>"H" definition</p>
LED	CLU 026		
LES / LED Size	Φ 9.8 mm		
FWHM (D50)	23°		
Field Angle (D10)	47°		
H (distance)	3.65 mm		
Dimension	Φ =60 mm, Thickness=26.85 mm		
Luminous Flux	1541 lm	Measured @ 12.4 W	
Material	PC / UL94V2		

cd/klm

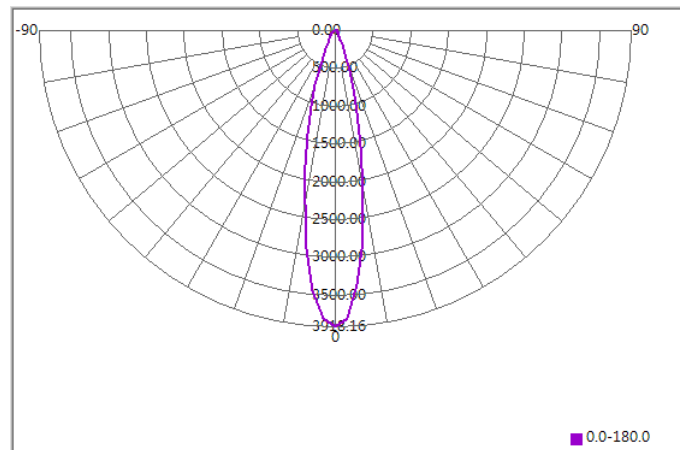

Illuminance At Distances

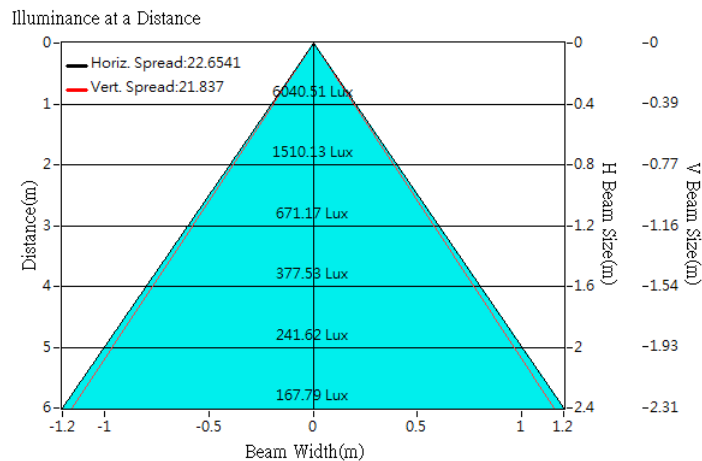



Optical Characteristics

Model Number	CKO-CS15-060027-4204		<p>"H" definition</p>
LED	CLU 721		
LES / LED Size	Φ 11 mm		
FWHM (D50)	24°		
Field Angle (D10)	50°		
H (distance)	3.65 mm		
Dimension	Φ =60 mm, Thickness=26.85 mm		
Luminous Flux	4026 lm	Measured @ 38.6 W	
Material	PC / UL94V2		

cd/klm

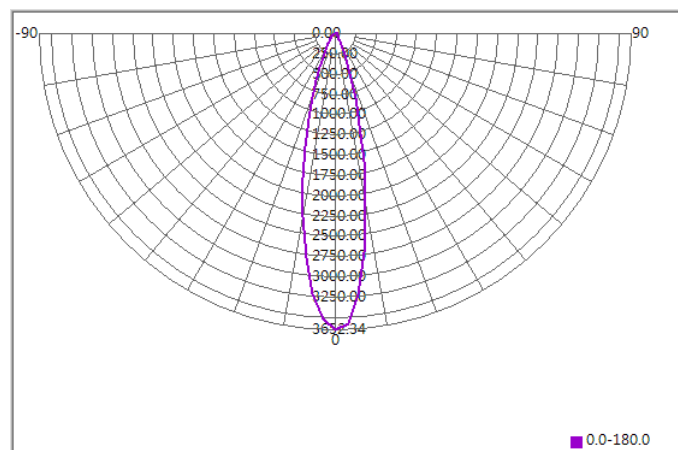

Illuminance At Distances

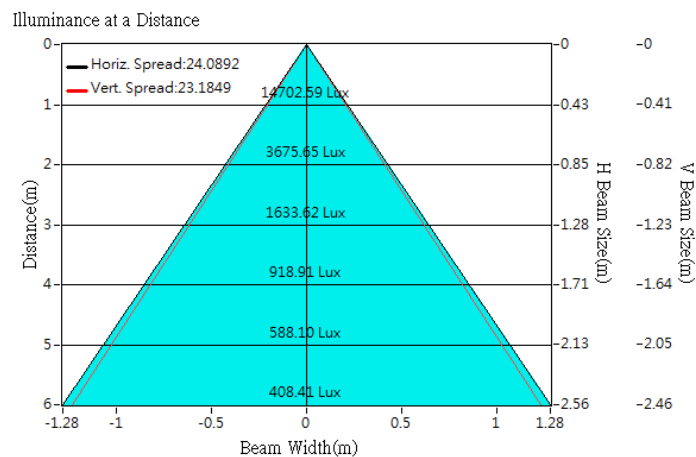



Optical Characteristics

Model Number	CKO-CS15-060027-4204		<p>"H" definition</p>
LED	CLU 038		
LES / LED Size	Φ 14.5 mm		
FWHM (D50)	26°		
Field Angle (D10)	53°		
H (distance)	3.65 mm		
Dimension	Φ =60 mm, Thickness=26.85 mm		
Luminous Flux	2802 lm	Measured @ 25.1 W	
Material	PC / UL94V2		

cd/klm

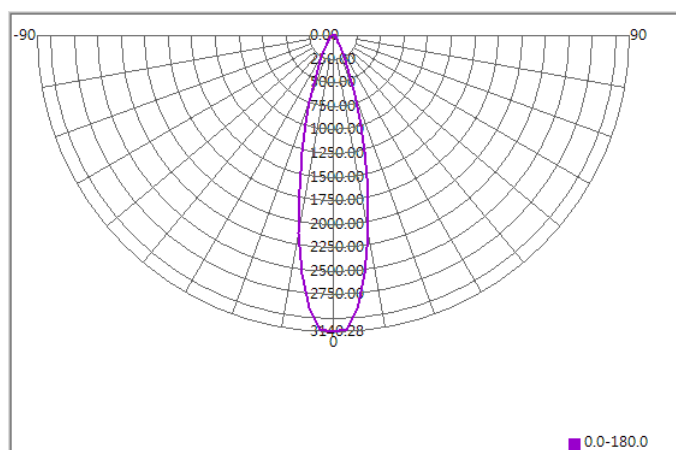

Illuminance At Distances

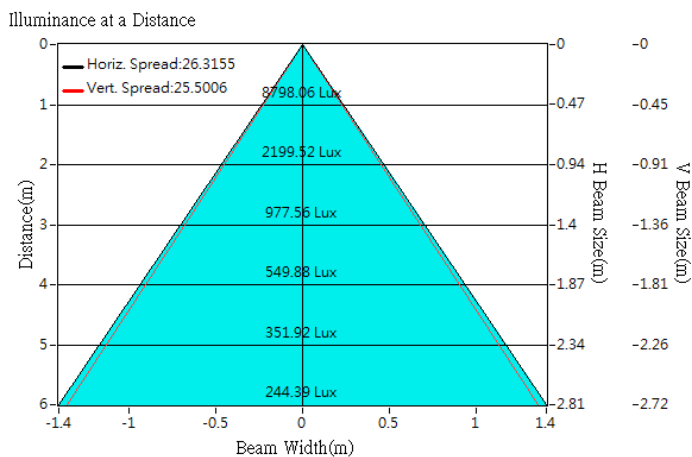



Optical Characteristics

Model Number	CKO-CS15-060027-4204		<p>"H" definition</p> <p>LES CoB</p>
LED	CLU 036		
LES / LED Size	Φ 14.5 mm		
FWHM (D50)	28°		
Field Angle (D10)	54°		
H (distance)	3.65 mm		
Dimension	Φ =60 mm, Thickness=26.85 mm		
Luminous Flux	1913 lm	Measured @ 15.7 W	
Material	PC / UL94V2		

cd/klm

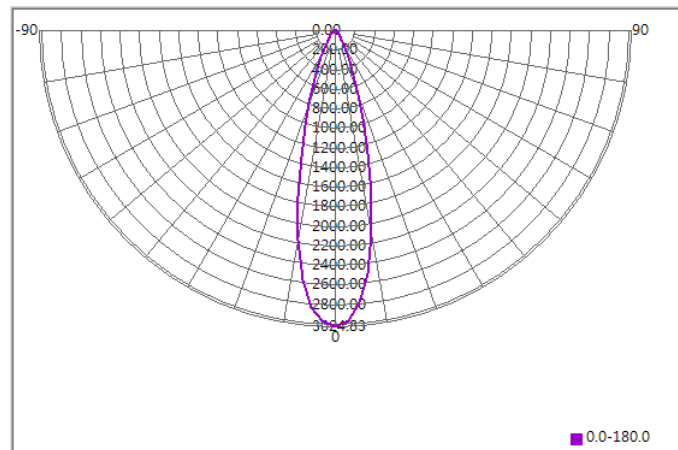

Illuminance At Distances

