



Product Model Number

CKO-CS15-060027-4204

✓ Model Number Definitions

CKO-XXXX-XXXXXX-XXXX



- A. Chun Kuang Optics Corp. Product
- B. Product Type: product abbreviation
Ex:
CH→CoB High Intensity
CC→CoB Compact
CS→Soft Shading for CoB LED
HC→Holder for CoB LED

- C. Identity Code
- D. Lens / Fixture Size
Ex: 075026=Φ75mm / Thickness=26mm (round up)
- C. Serial Numbers

The lens datasheet is applicable for **Philips LED**, that manufactured by Chun Kuang Optics Corp.

✓ Dimensions (mm) : Φ60 x 26.85

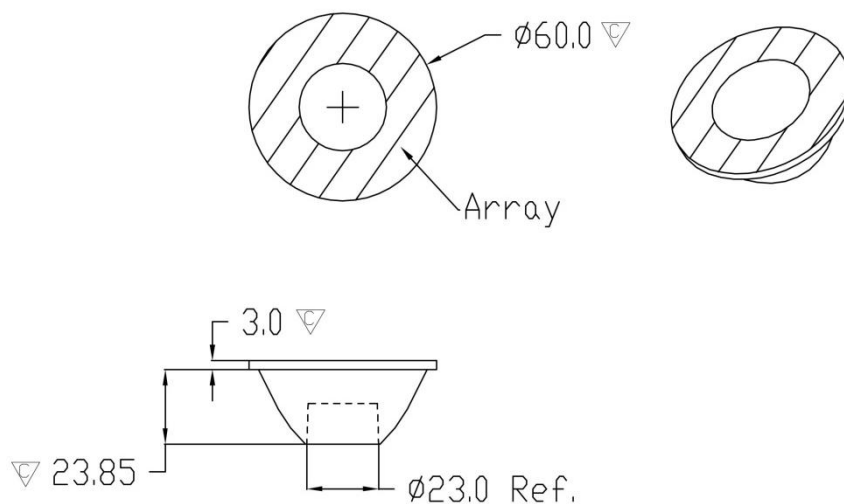

∇ :Critical Dimension



Optical Characteristics

Model Number	CKO-CS15-060027-4204		<p>"H" definition</p>
LED	Fortimo SLM 1203 L09 G6_DL		
LES / LED Size	Φ 9 mm		
FWHM (D50)	21°		
Field Angle (D10)	45°		
H (distance)	3.5 mm		
Dimension	Φ =60 mm, Thickness=26.85 mm		
Luminous Flux	1224 lm	Measured @ 10.4 W	
Material	PC / UL94V2		

cd/klm

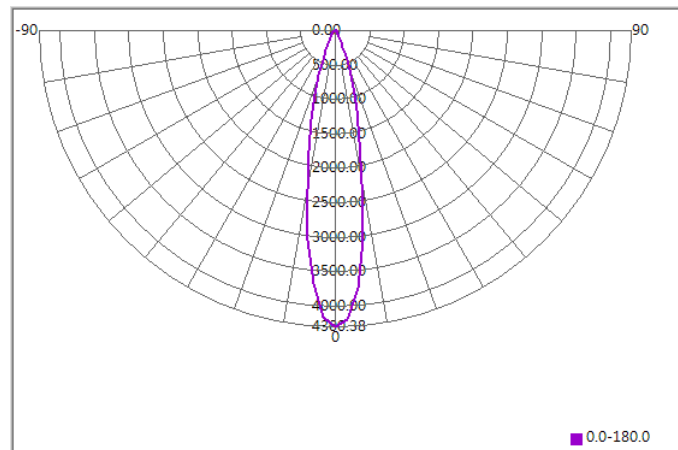

Illuminance At Distances

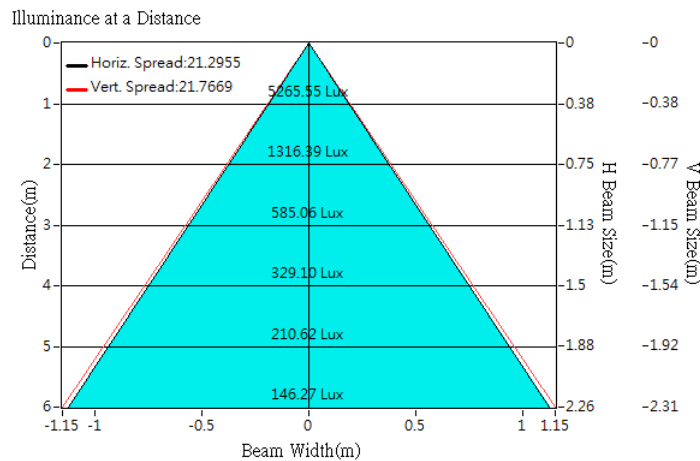



Optical Characteristics

Model Number	CKO-CS15-060027-4204		<p>"H" definition</p>
LED	Fortimo SLM 1203 L09 G6_PI		
LES / LED Size	Φ 9 mm		
FWHM (D50)	21°		
Field Angle (D10)	45°		
H (distance)	3.5 mm		
Dimension	Φ =60 mm, Thickness=26.85 mm		
Luminous Flux	1224 lm	Measured @ 10.4 W	
Material	PC / UL94V2		

cd/klm

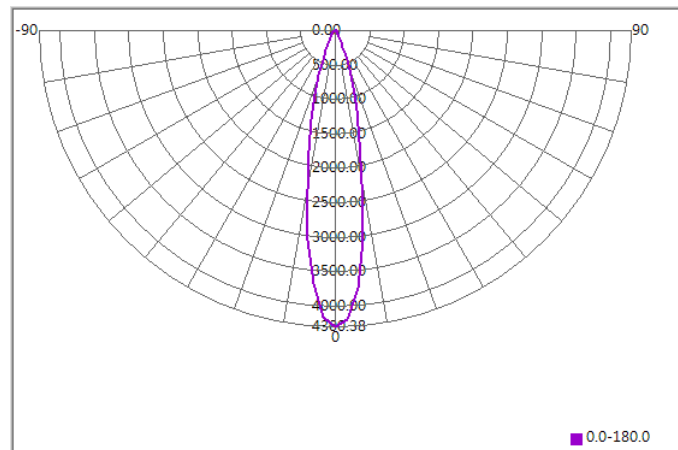

Illuminance At Distances

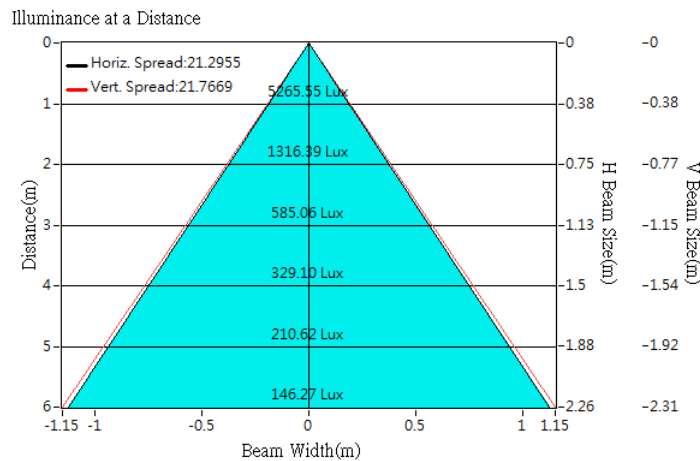



Optical Characteristics

Model Number	CKO-CS15-060027-4204		<p>"H" definition</p>
LED	Fortimo SLM PW 1204 L09 G7		
LES / LED Size	Φ 9 mm		
FWHM (D50)	21°		
Field Angle (D10)	44°		
H (distance)	3.65 mm		
Dimension	Φ =60 mm, Thickness=26.85 mm		
Luminous Flux	2547 lm	Measured @ 25.62 W	
Material	PC / UL94V2		

cd/klm

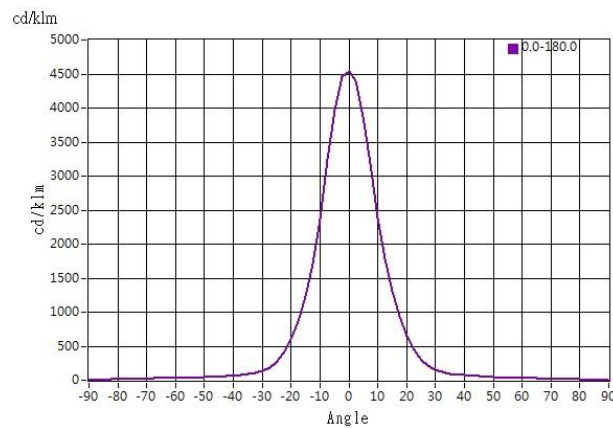

Illuminance At Distances

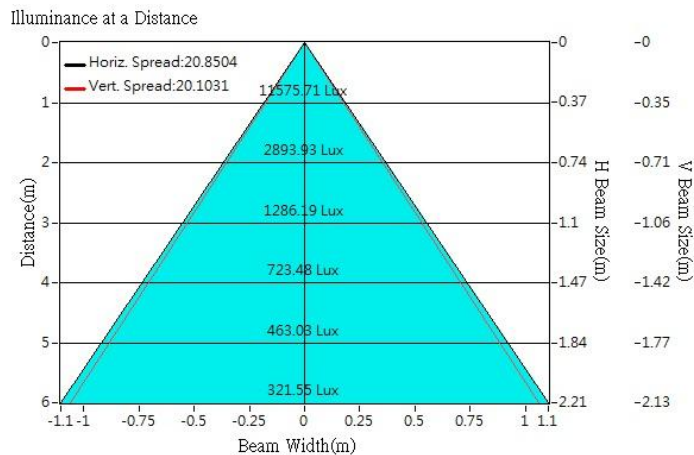



Optical Characteristics

Model Number	CKO-CS15-060027-4204		<p>"H" definition</p> <p>LES CoB "H" mm (distance)</p>
LED	Fortimo SLM 1201 L09 G7N		
LES / LED Size	Φ 9.8 mm		
FWHM (D50)	22°		
Field Angle (D10)	46°		
H (distance)	3.65 mm		
Dimension	Φ =60 mm, Thickness=26.85 mm		
Luminous Flux	444 lm	Measured @ 3.0 W	
Material	PC / UL94V2		

cd/klm

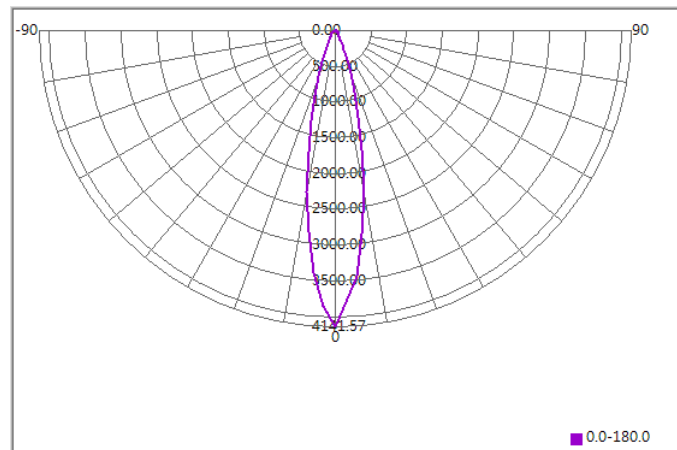

Illuminance At Distances

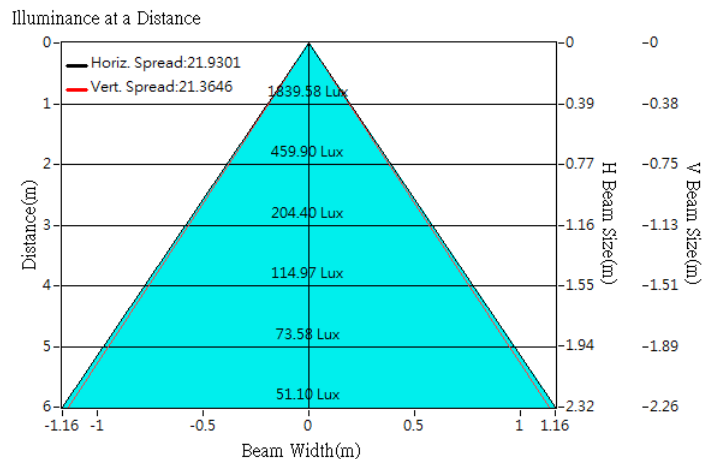



Optical Characteristics

Model Number	CKO-CS15-060027-4204		<p>"H" definition</p>
LED	Fortimo SLM 1202 L09 G7N		
LES / LED Size	Φ 9.8 mm		
FWHM (D50)	23°		
Field Angle (D10)	47°		
H (distance)	3.65 mm		
Dimension	Φ =60 mm, Thickness=26.85 mm		
Luminous Flux	854 lm	Measured @ 6.1 W	
Material	PC / UL94V2		

cd/klm

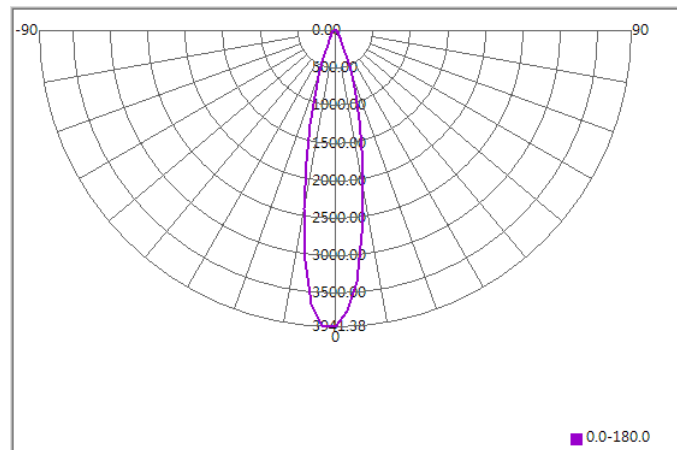

Illuminance At Distances

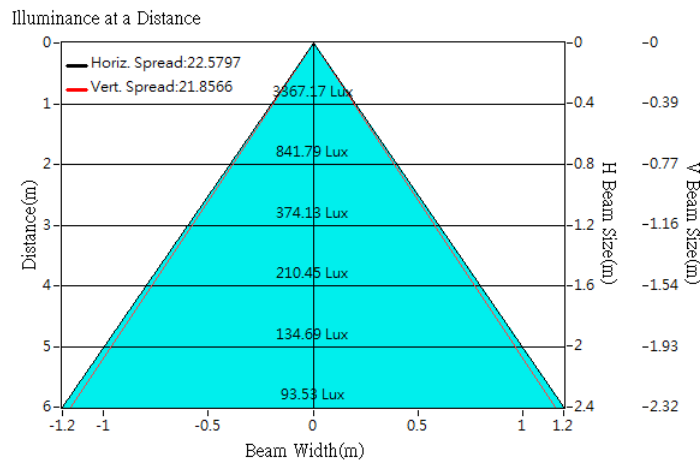



Optical Characteristics

Model Number	CKO-CS15-060027-4204	<p>"H" definition</p> <p>LES CoB</p>
LED	Fortimo SLM 1204 L09 G7N	
LES / LED Size	Φ 9.8 mm	
FWHM (D50)	23°	
Field Angle (D10)	47°	
H (distance)	3.65 mm	
Dimension	Φ =60 mm, Thickness=26.85 mm	
Luminous Flux	1669 lm	
Material	PC / UL94V2	

cd/klm

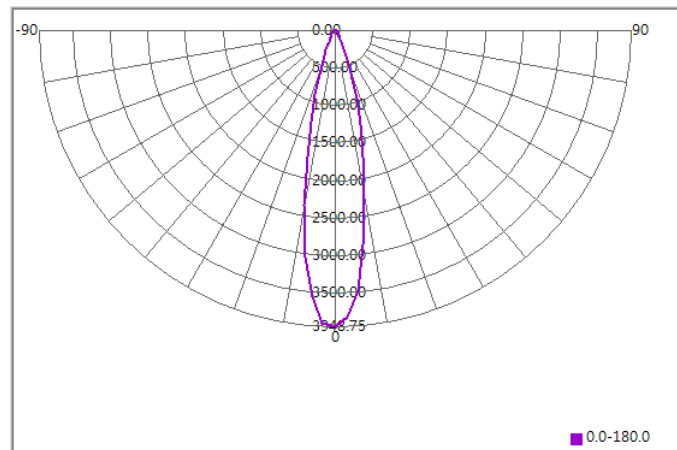

Illuminance At Distances

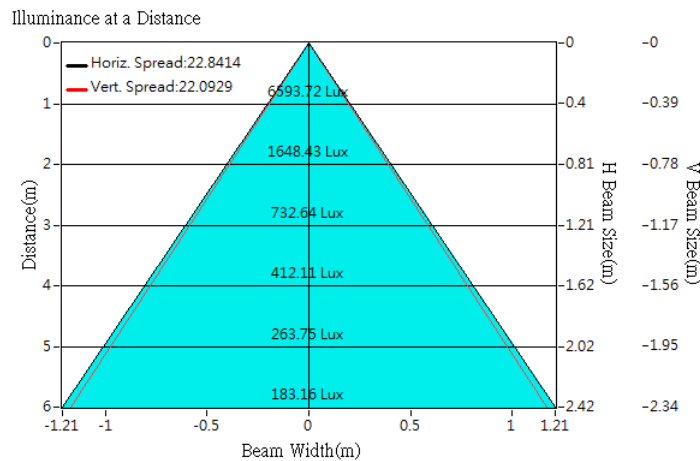

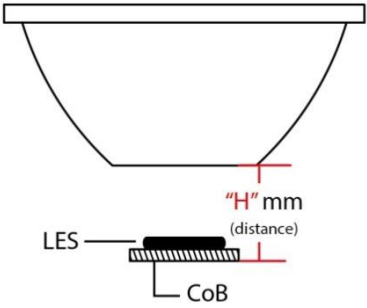

Optical Characteristics

Model Number	CKO-CS15-060027-4204		<p>"H" definition</p> 
LED	Fortimo SLM 1205 L13 G7		
LES / LED Size	Φ 13mm		
FWHM (D50)	27°		
Field Angle (D10)	52°		
H (distance)	4 mm		
Dimension	Φ =60 mm, Thickness=26.85 mm		
Luminous Flux	2181 lm	Measured @ 17.6W	
Material	PC / UL94V2		

cd/klm

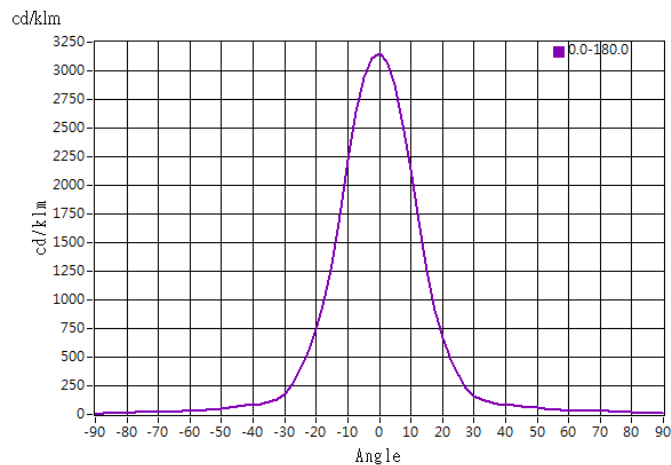

Illuminance At Distances

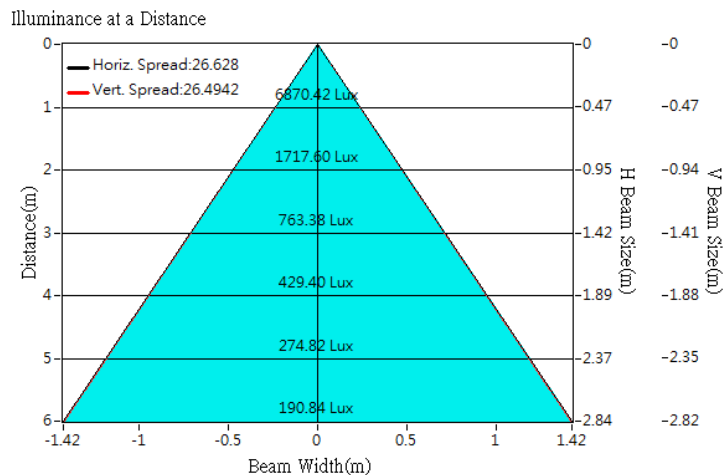



Optical Characteristics

Model Number	CKO-CS15-060027-4204		<p>"H" definition</p> <p>LES</p> <p>CoB</p>
LED	Fortimo SLM 1205 L15 G7N		
LES / LED Size	Φ 14.5 mm		
FWHM (D50)	28°		
Field Angle (D10)	55°		
H (distance)	3.65 mm		
Dimension	Φ =60 mm, Thickness=26.85 mm		
Luminous Flux	2115 lm	Measured @ 15.4 W	
Material	PC / UL94V2		

cd/klm

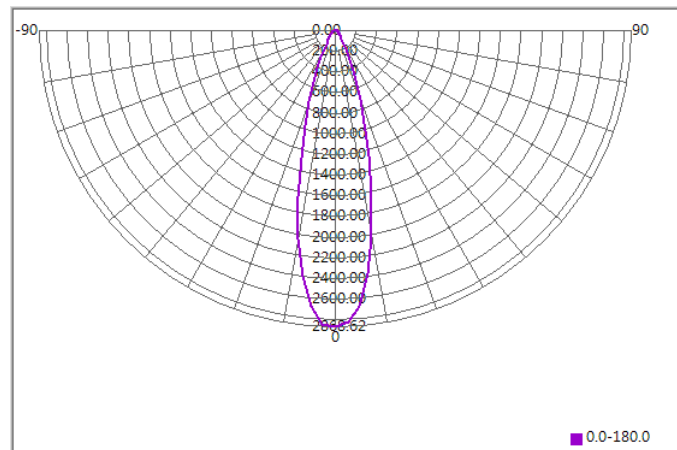

Illuminance At Distances

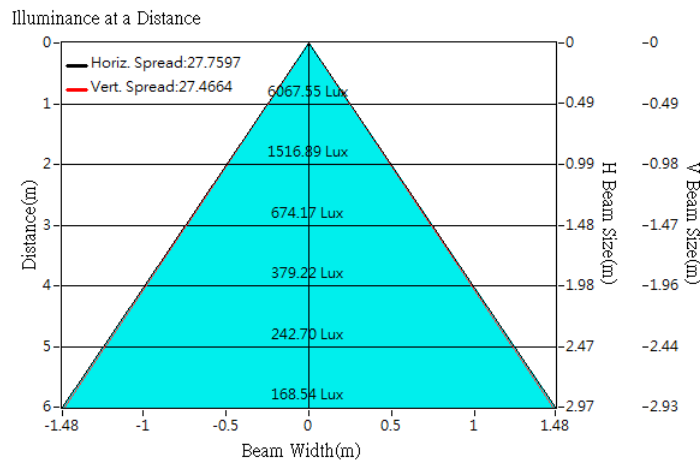



Optical Characteristics

Model Number	CKO-CS15-060027-4204		<p>"H" definition</p> <p>LES</p> <p>CoB</p>
LED	Fortimo SLM 1206 L15 G7N		
LES / LED Size	Φ 14.5 mm		
FWHM (D50)	28°		
Field Angle (D10)	55°		
H (distance)	3.65 mm		
Dimension	Φ =60 mm, Thickness=26.85 mm		
Luminous Flux	2524 lm	Measured @ 18.5 W	
Material	PC / UL94V2		

cd/klm

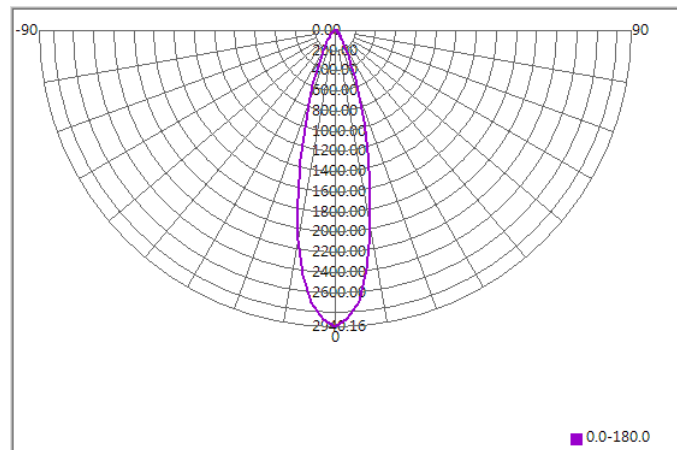

Illuminance At Distances

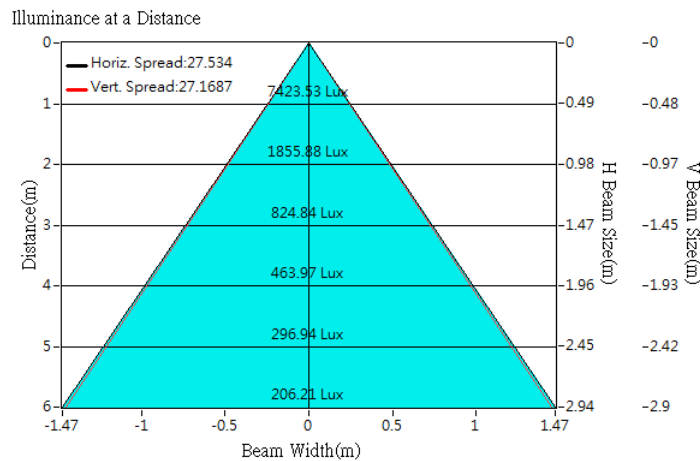



Optical Characteristics

Model Number	CKO-CS15-060027-4204		<p>"H" definition</p> <p>LES</p> <p>CoB</p>
LED	Fortimo SLM 1208 L15 G7N		
LES / LED Size	Φ 14.5 mm		
FWHM (D50)	28°		
Field Angle (D10)	56°		
H (distance)	3.65 mm		
Dimension	Φ =60 mm, Thickness=26.85 mm		
Luminous Flux	3497 lm	Measured @ 24.7 W	
Material	PC / UL94V2		

cd/klm

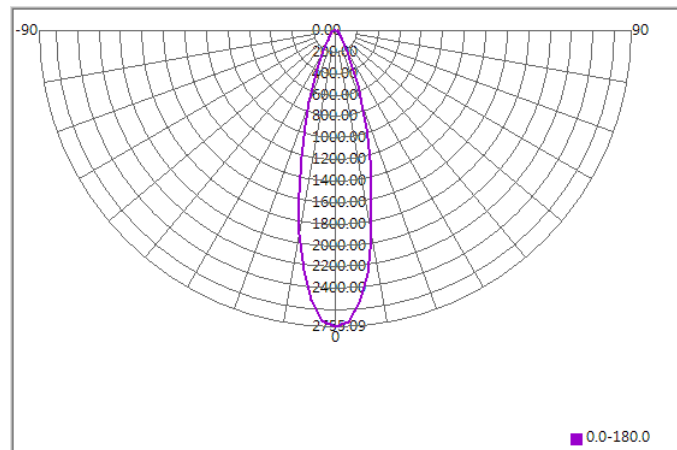

Illuminance At Distances

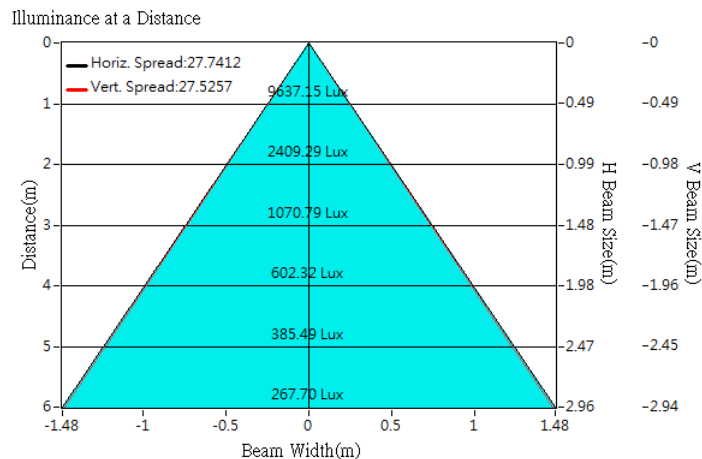



Optical Characteristics

Model Number	CKO-CS15-060027-4204		
LED	Fortimo SLM 1210 L15 G7N		
LES / LED Size	Φ 14.5 mm		
FWHM (D50)	27°		
Field Angle (D10)	56°		
H (distance)	3.65 mm		
Dimension	Φ =60 mm, Thickness=26.85 mm		
Luminous Flux	3971 lm	Measured @ 31.1 W	
Material	PC / UL94V2		

cd/klm

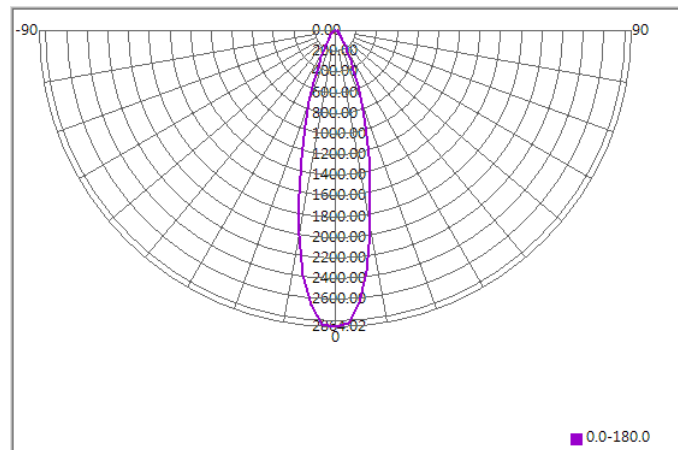

Illuminance At Distances

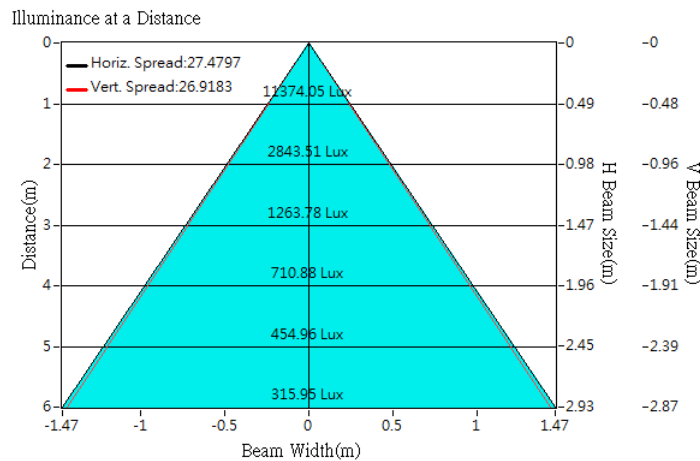

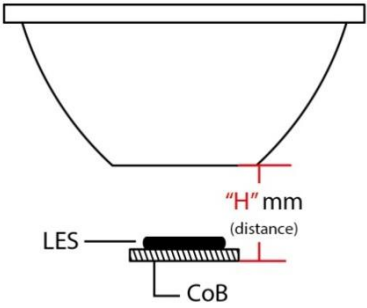

Optical Characteristics

Model Number	CKO-CS15-060027-4204		<p>"H" definition</p> 
LED	Fortimo SLM 1208 L15 G7		
LES / LED Size	Φ 15 mm		
FWHM (D50)	28°		
Field Angle (D10)	54°		
H (distance)	4 mm		
Dimension	Φ =60 mm, Thickness=26.85 mm		
Luminous Flux	2953 lm	Measured @ 25.8W	
Material	PC / UL94V2		

cd/klm

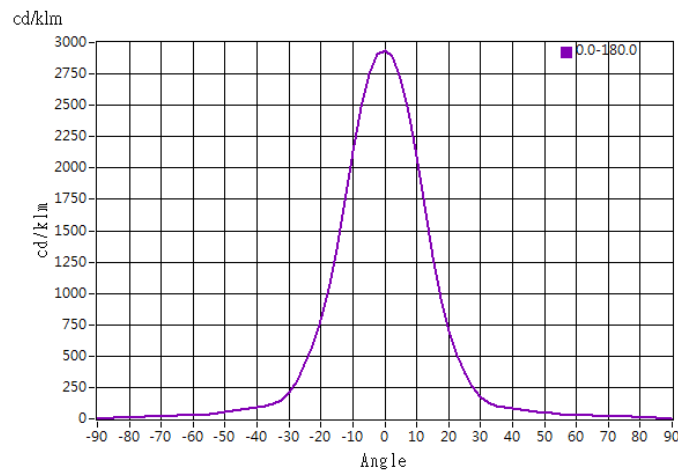

Illuminance At Distances

