



Product Model Number

CKO-CS15-060027-4206

✓ Model Number Definitions

CKO-XXXX-XXXXXX-XXXX

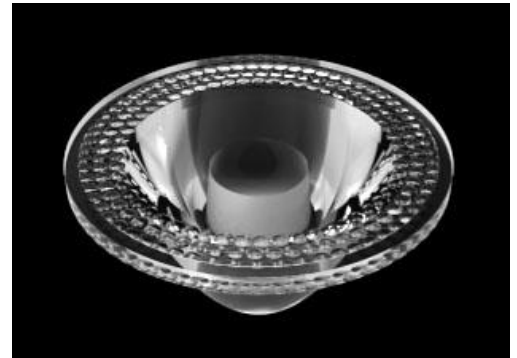

- A. Chun Kuang Optics Corp. Product
- B. Product Type: product abbreviation
Ex:
CH→CoB High Intensity
CC→CoB Compact
CS→Soft Shading for CoB LED
HC→Holder for CoB LED

- C. Identity Code
- D. Lens / Fixture Size
Ex: 075026=Φ75mm / Thickness=26mm (round up)
- C. Serial Numbers

The lens datasheet is applicable for **TRIDONIC LED**, that manufactured by Chun Kuang Optics Corp.

✓ Dimensions (mm) : Φ60 x 26.85

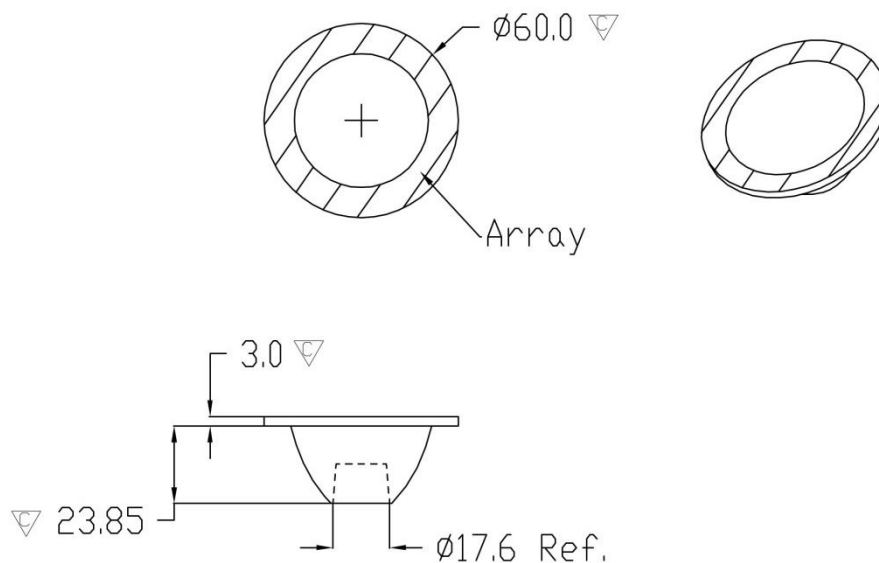

▽:Critical Dimension



Optical Characteristics

Model Number	CKO-CS15-060027-4206		<p>"H" definition</p>
LED	SLE G7 09mm 1200lm 940 R ADV		
LES / LED Size	Φ 9 mm		
FWHM (D50)	33°		
Field Angle (D10)	49°		
H (distance)	3.65 mm		
Dimension	Φ =60 mm, Thickness=26.85 mm		
Luminous Flux	1461 lm	Measured @ 12.3 W	
Material	PC / UL94V2		

cd/klm

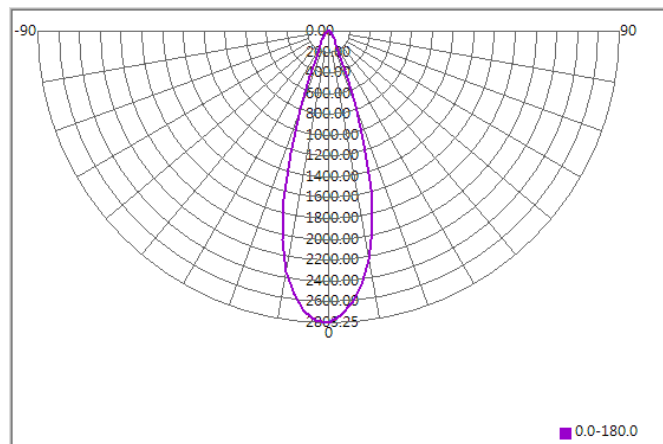

Illuminance At Distances

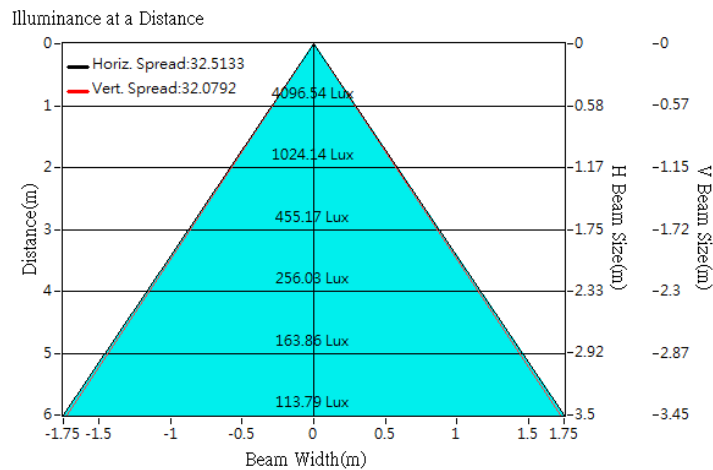



Optical Characteristics

Model Number	CKO-CS15-060027-4206		<p>"H" definition</p>
LED	SLE G7 13mm 3000lm 930 R ADV		
LES / LED Size	Φ 13 mm		
FWHM (D50)	39°		
Field Angle (D10)	62°		
H (distance)	3.65 mm		
Dimension	Φ =60 mm, Thickness=26.85 mm		
Luminous Flux	2020 lm	Measured @ 17.2 W	
Material	PC / UL94V2		

cd/klm

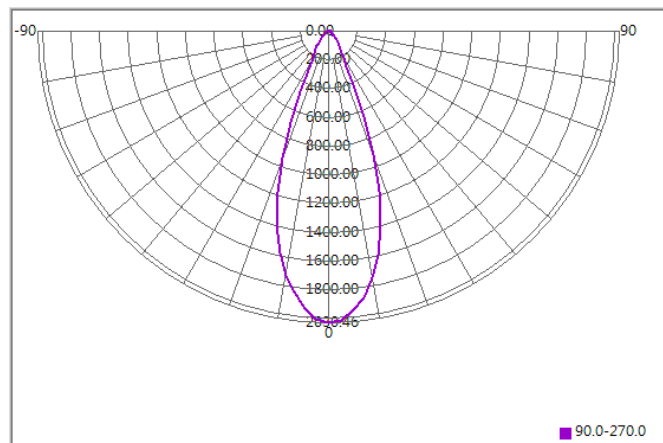

Illuminance At Distances

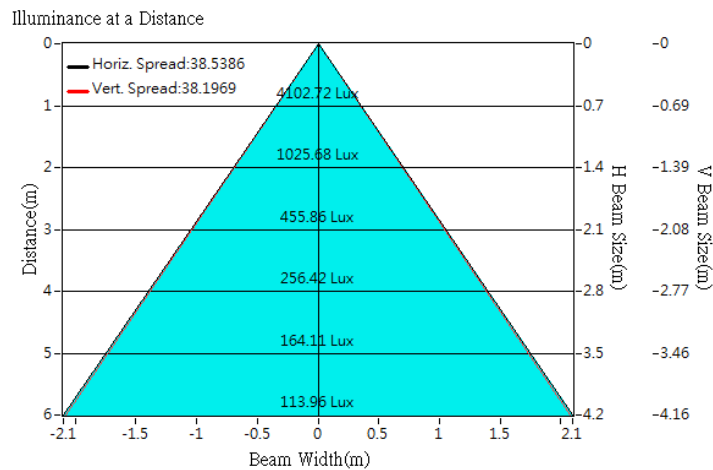



Optical Characteristics

Model Number	CKO-CS15-060027-4206		<p>"H" definition</p> <p>LES CoB "H" mm (distance)</p>
LED	SLE G7 15mm 4000lm 840 R ADV		
LES / LED Size	Φ 15 mm		
FWHM (D50)	42°		
Field Angle (D10)	70°		
H (distance)	3.65 mm		
Dimension	Φ =60 mm, Thickness=26.85 mm		
Luminous Flux	4115 lm	Measured @ 33.3 W	
Material	PC / UL94V2		

cd/klm

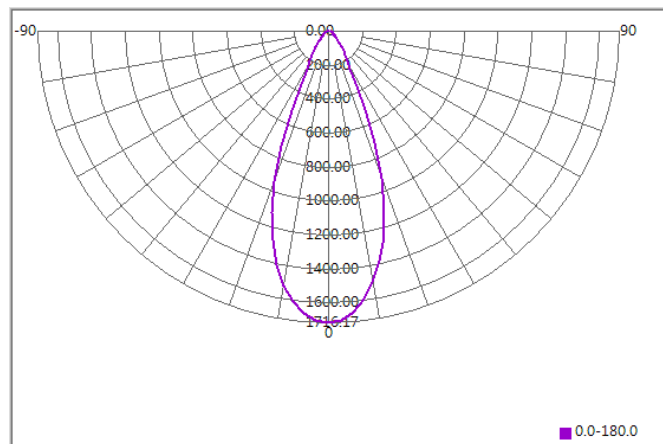

Illuminance At Distances

