



Product Model Number

CKO-CS15-075033-4003

✓ Model Number Definitions

CKO-XXXX-XXXXXX-XXXX



- A. Chun Kuang Optics Corp. Product
- B. Product Type: product abbreviation
Ex:
CH→CoB High Intensity
CC→CoB Compact
CS→Soft Shading for CoB LED
HC→Holder for CoB LED

- C. Identity Code
- D. Lens / Fixture Size
Ex: 075026=Φ75mm / Thickness=26mm (round up)
- C. Serial Numbers

The lens datasheet is applicable for **Citizen LED**, that manufactured by Chun Kuang Optics Corp.

✓ Dimensions (mm) : Φ75 x 33

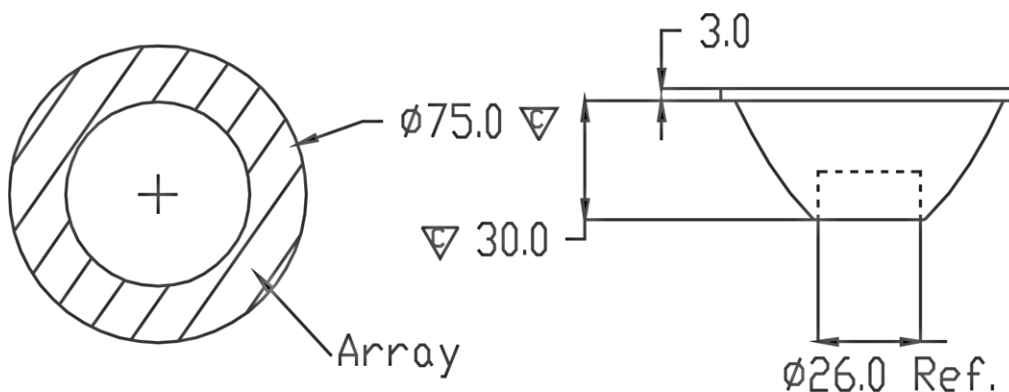

∇ :Critical Dimension



Optical Characteristics

Model Number	CKO-CS15-075033-4003		<p>"H" definition</p>
LED	CLU 711		
LES / LED Size	Φ 8.5 mm		
FWHM (D50)	14°		
Field Angle (D10)	30°		
H (distance)	3.65 mm		
Dimension	Φ =75 mm, Thickness=33 mm		
Luminous Flux	2738 lm	Measured @ 25.6 W	
Material	PC / UL94V2		

cd/klm

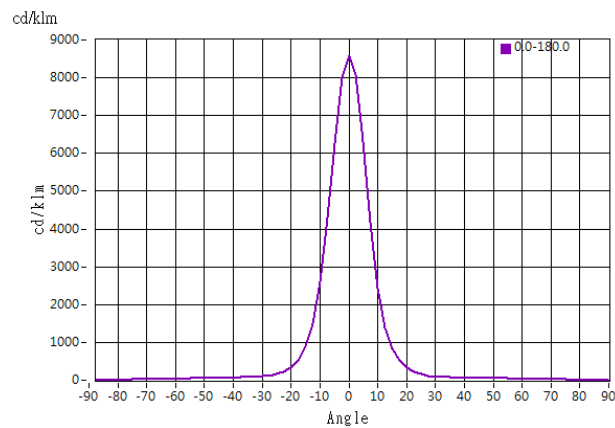

Illuminance At Distances

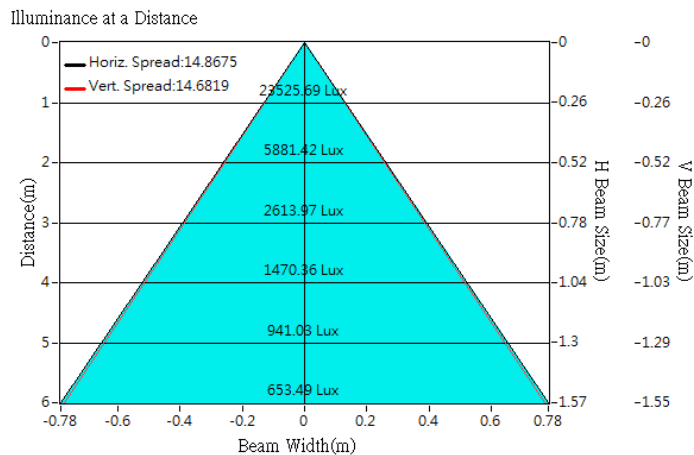



Optical Characteristics

Model Number	CKO-CS15-075033-4003		<p>"H" definition</p>
LED	CLU 710		
LES / LED Size	Φ 8.5 mm		
FWHM (D50)	14°		
Field Angle (D10)	30°		
H (distance)	3.65 mm		
Dimension	Φ =75 mm, Thickness=33 mm		
Luminous Flux	2442 lm	Measured @ 26.2 W	
Material	PC / UL94V2		

cd/klm

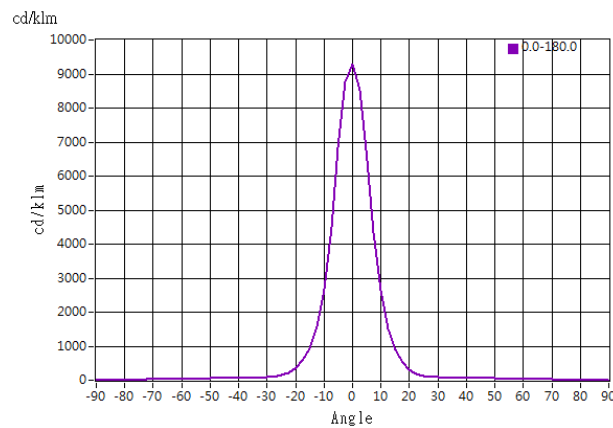

Illuminance At Distances

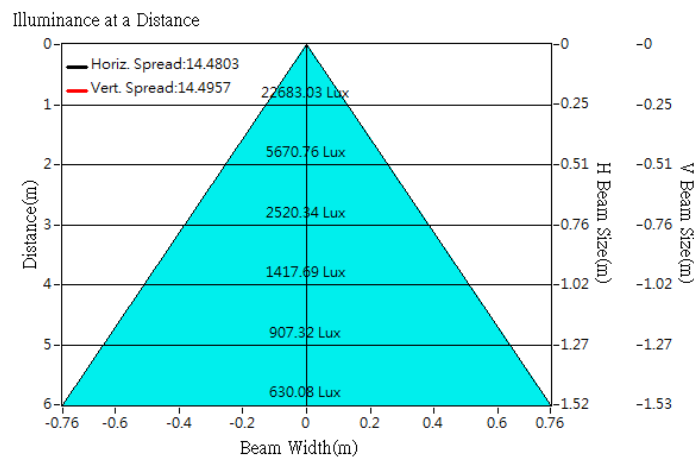



Optical Characteristics

Model Number	CKO-CS15-075033-4003		<p>"H" definition</p>
LED	CLU 028		
LES / LED Size	Φ 9.8 mm		
FWHM (D50)	16°		
Field Angle (D10)	31°		
H (distance)	3.65 mm		
Dimension	Φ =75 mm, Thickness=33 mm		
Luminous Flux	1592 lm	Measured @ 12.5 W	
Material	PC / UL94V2		

cd/klm

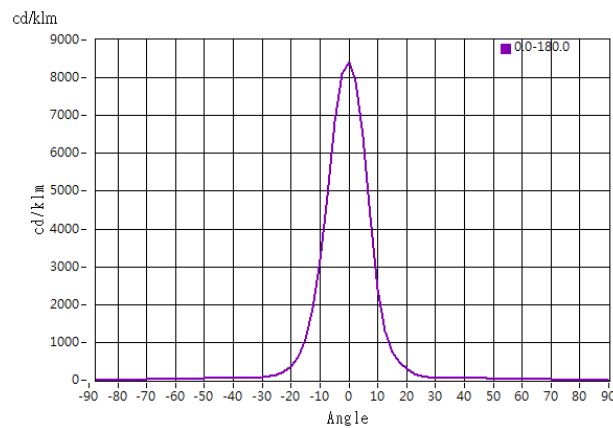

Illuminance At Distances

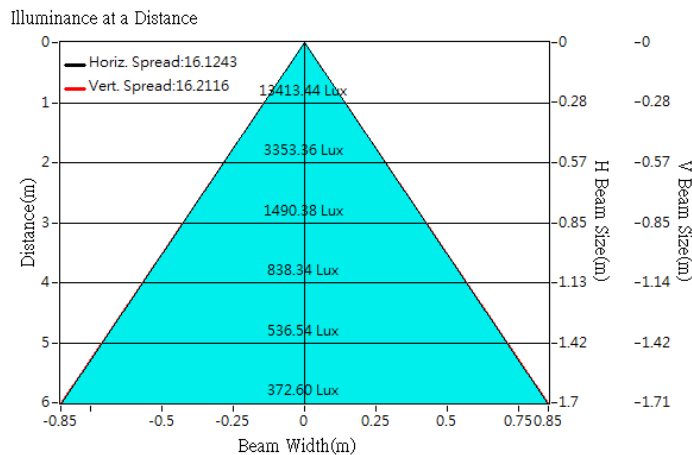



Optical Characteristics

Model Number	CKO-CS15-075033-4003		<p>"H" definition</p>
LED	CLU 026		
LES / LED Size	Φ 9.8 mm		
FWHM (D50)	16°		
Field Angle (D10)	32°		
H (distance)	3.65 mm		
Dimension	Φ =75 mm, Thickness=33 mm		
Luminous Flux	1546 lm	Measured @ 12.3 W	
Material	PC / UL94V2		

cd/klm

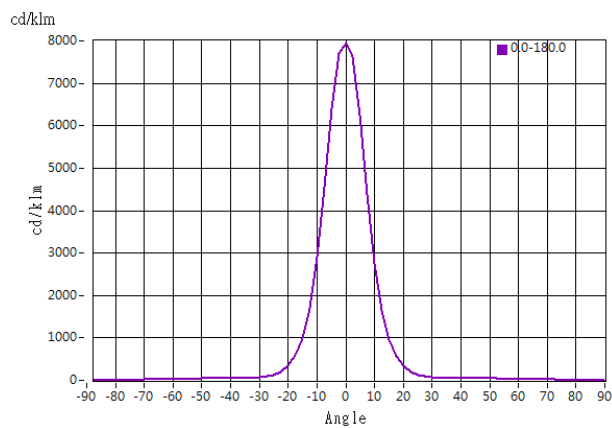

Illuminance At Distances

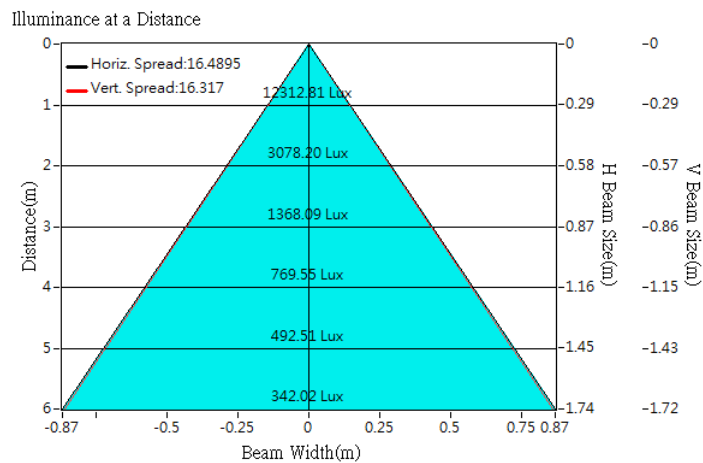



Optical Characteristics

Model Number	CKO-CS15-075033-4003		<p>"H" definition</p>
LED	CLU 721		
LES / LED Size	Φ 11 mm		
FWHM (D50)	18°		
Field Angle (D10)	33°		
H (distance)	3.65 mm		
Dimension	Φ =75 mm, Thickness=33 mm		
Luminous Flux	4099 lm	Measured @ 38.8 W	
Material	PC / UL94V2		

cd/klm

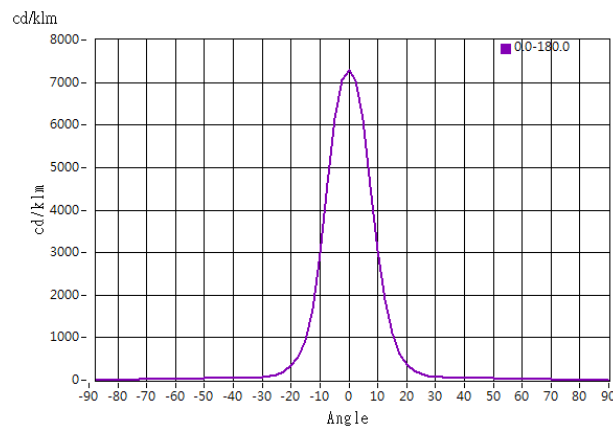

Illuminance At Distances

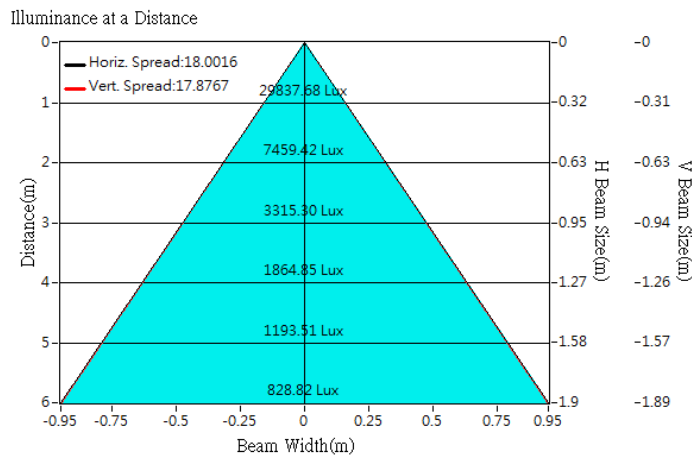



Optical Characteristics

Model Number	CKO-CS15-075033-4003		<p>"H" definition</p>
LED	CLU 720		
LES / LED Size	Φ 11 mm		
FWHM (D50)	17°		
Field Angle (D10)	34°		
H (distance)	3.65 mm		
Dimension	Φ =75 mm, Thickness=33 mm		
Luminous Flux	3548 lm	Measured @ 38.7 W	
Material	PC / UL94V2		

cd/klm

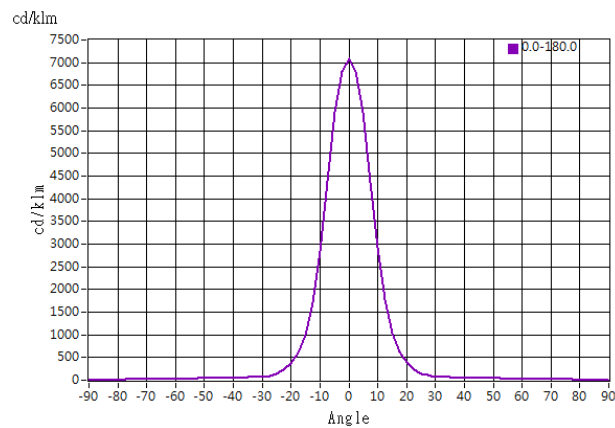

Illuminance At Distances

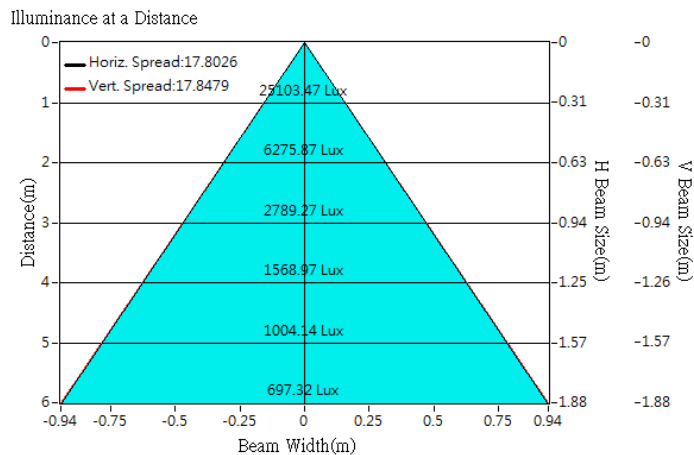



Optical Characteristics

Model Number	CKO-CS15-075033-4003		<p>"H" definition</p>
LED	CLU 730		
LES / LED Size	Φ 13 mm		
FWHM (D50)	21°		
Field Angle (D10)	39°		
H (distance)	3.65 mm		
Dimension	Φ =75 mm, Thickness=33 mm		
Luminous Flux	4861 lm	Measured @ 64.3 W	
Material	PC / UL94V2		

cd/klm

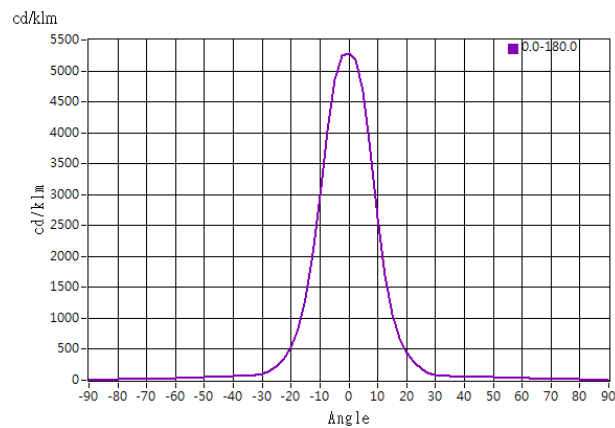

Illuminance At Distances

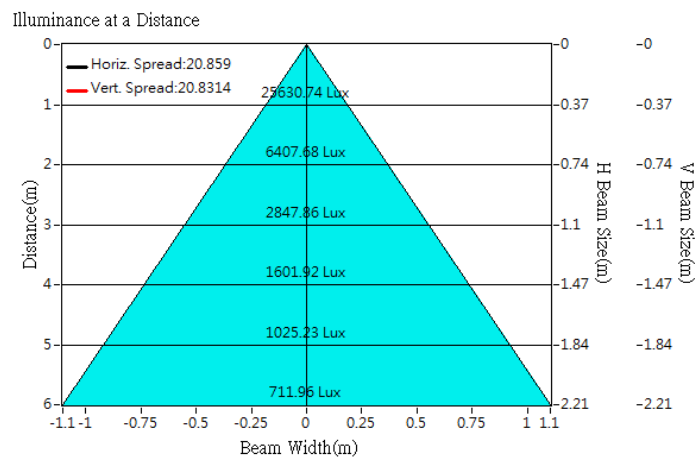



Optical Characteristics

Model Number	CKO-CS15-075033-4003		<p>"H" definition</p>
LED	CLU 038		
LES / LED Size	Φ 14.5 mm		
FWHM (D50)	21°		
Field Angle (D10)	41°		
H (distance)	3.65 mm		
Dimension	Φ =75 mm, Thickness=33 mm		
Luminous Flux	2684 lm	Measured @ 25.4 W	
Material	PC / UL94V2		

cd/klm

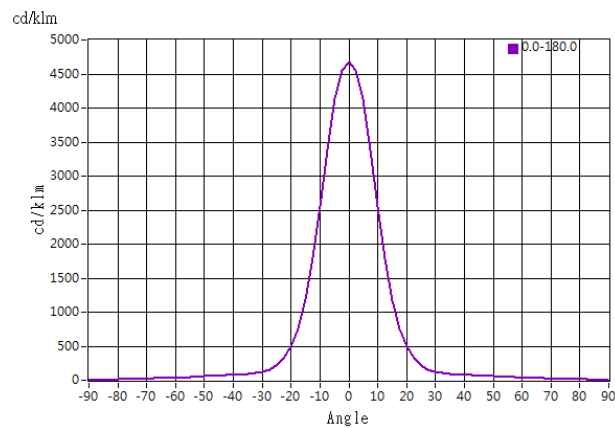

Illuminance At Distances

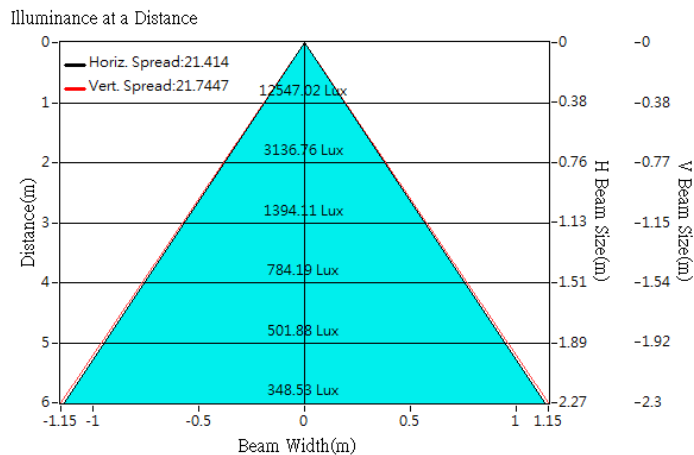



Optical Characteristics

Model Number	CKO-CS15-075033-4003		<p>"H" definition</p> <p>LES CoB "H" mm (distance)</p>
LED	CLU 036		
LES / LED Size	Φ 14.5 mm		
FWHM (D50)	24°		
Field Angle (D10)	42°		
H (distance)	3.65 mm		
Dimension	Φ =75 mm, Thickness=33 mm		
Luminous Flux	1950 lm	Measured @ 15.7 W	
Material	PC / UL94V2		

cd/klm

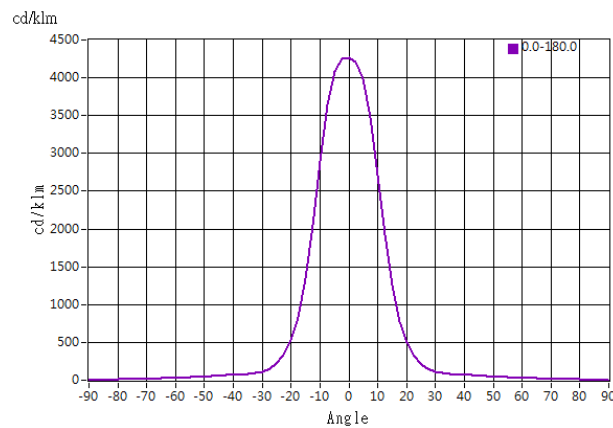

Illuminance At Distances

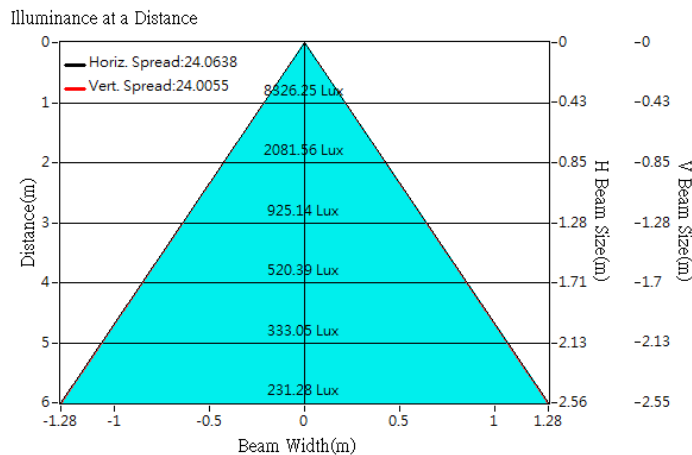



Optical Characteristics

Model Number	CKO-CS15-075033-4003		<p>"H" definition</p>
LED	CLU 048		
LES / LED Size	Φ 22 mm		
FWHM (D50)	31°		
Field Angle (D10)	59°		
H (distance)	3.65 mm		
Dimension	Φ =75 mm, Thickness=33 mm		
Luminous Flux	6935 lm	Measured @ 53.8 W	
Material	PC / UL94V2		

cd/klm

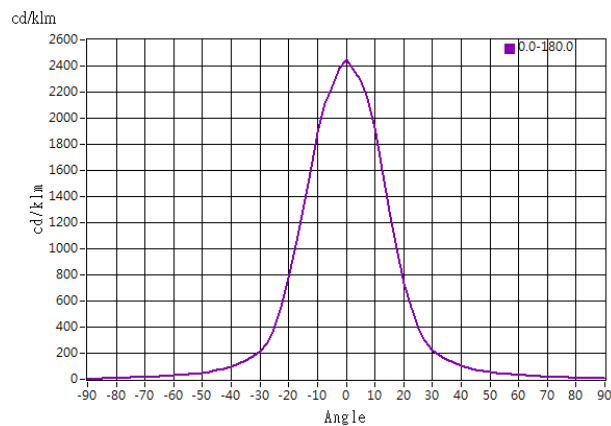

Illuminance At Distances

