



Product Model Number

CKO-CS15-075033-4003

✓ Model Number Definitions

CKO-XXXX-XXXXXX-XXXX



- A. Chun Kuang Optics Corp. Product
- B. Product Type: product abbreviation
Ex:
CH→CoB High Intensity
CC→CoB Compact
CS→Soft Shading for CoB LED
HC→Holder for CoB LED

- C. Identity Code
- D. Lens / Fixture Size
Ex: 075026=Φ75mm / Thickness=26mm (round up)
- C. Serial Numbers

The lens datasheet is applicable for **Nichia LED**, that manufactured by Chun Kuang Optics Corp.

✓ Dimensions (mm) : Φ75 x 33

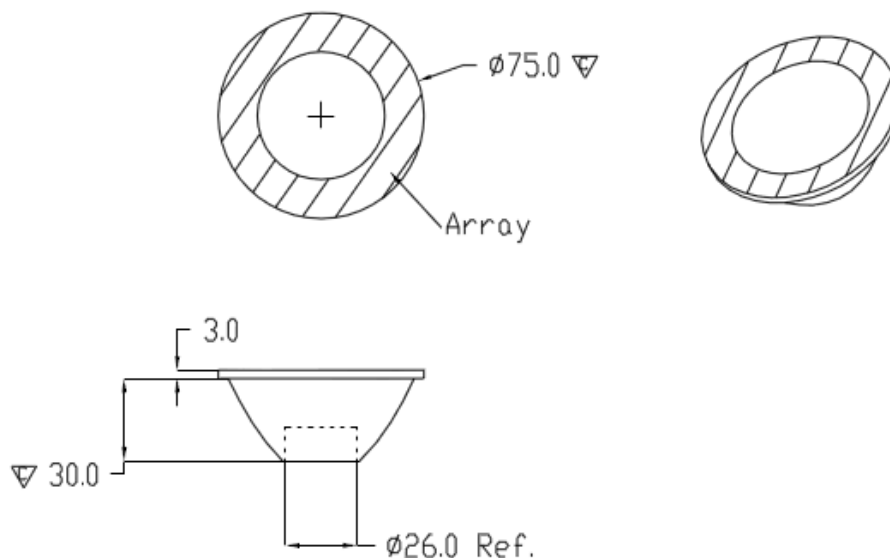

▽:Critical Dimension



Optical Characteristics

Model Number	CKO-CS15-075033-4003		<p>"H" definition</p>
LED	NFDWJ 130B		
LES / LED Size	Φ 14.6 mm		
FWHM (D50)	23°		
Field Angle (D10)	42°		
H (distance)	3.65 mm		
Dimension	Φ =75 mm, Thickness= 33 mm		
Luminous Flux	4851 lm	Measured @ 44.4 W	
Material	PC / UL94V2		

cd/klm

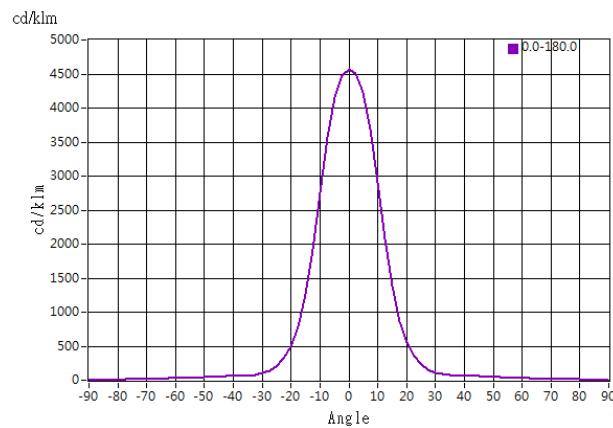

Illuminance At Distances

