



## Product Model Number

**CKO-CS18-035018-1303**

### ✓ Model Number Definitions

**CKO-XXXX-XXXXXX-XXXX**



- A. Chun Kuang Optics Corp. Product
- B. Product Type: product abbreviation  
Ex:  
CH→CoB High Intensity  
CC→CoB Compact  
CS→Soft Shading for CoB LED  
HC→Holder for CoB LED

- C. Identity Code
- D. Lens / Fixture Size  
Ex: 075026=Φ75mm / Thickness=26mm (round up)
- C. Serial Numbers

The lens datasheet is applicable for **Citizen LED**, that manufactured by Chun Kuang Optics Corp.

### ✓ Dimensions (mm) : Φ35 x 17.4

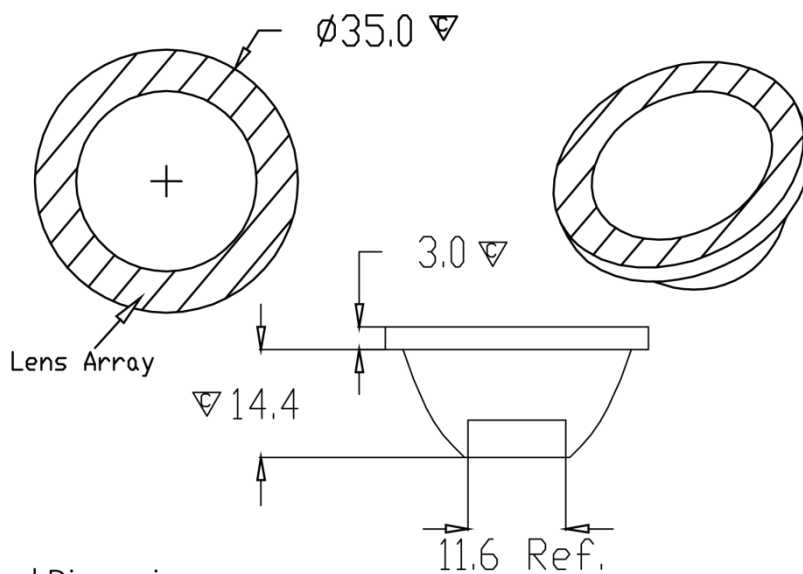

▽:Critical Dimension





## Optical Characteristics

Model Number	CKO-CS18-035018-1303		<p>"H" definition</p>
LED	<b>CLU 700</b>		
LES / LED Size	Φ 6 mm		
FWHM (D50)	24°		
Field Angle (D10)	48°		
H (distance)	2.5mm		
Dimension	Φ =35 mm, Thickness=17.4 mm		
Luminous Flux	1427 lm	Measured @ 14.4 W	
Material	PC / UL94V2		

## cd/klm

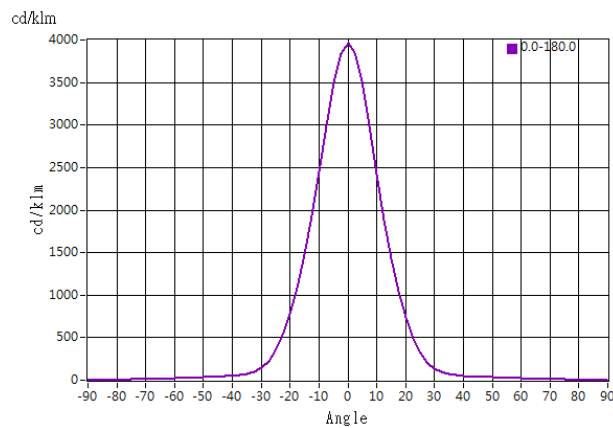

## Illuminance At Distances

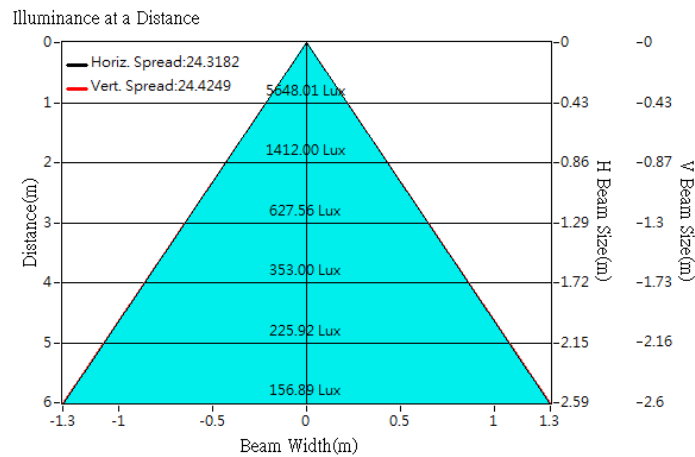



## Optical Characteristics

Model Number	CKO-CS18-035018-1303		<p>"H" definition</p>
LED	<b>CLU 701</b>		
LES / LED Size	Φ 6 mm		
FWHM (D50)	24°		
Field Angle (D10)	48°		
H (distance)	2.5mm		
Dimension	Φ =35 mm, Thickness=17.4 mm		
Luminous Flux	1075 lm	Measured @ 10.8 W	
Material	PC / UL94V2		

## cd/klm

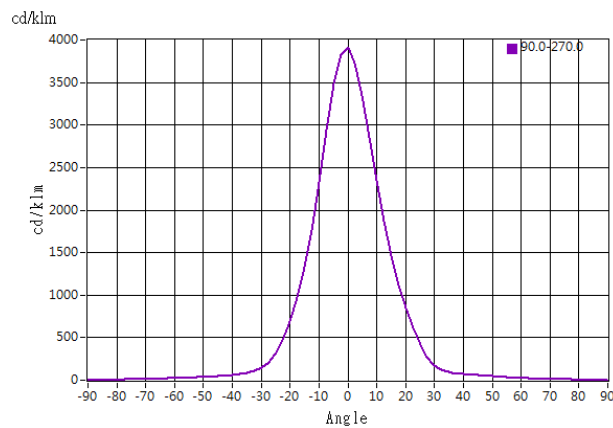

## Illuminance At Distances

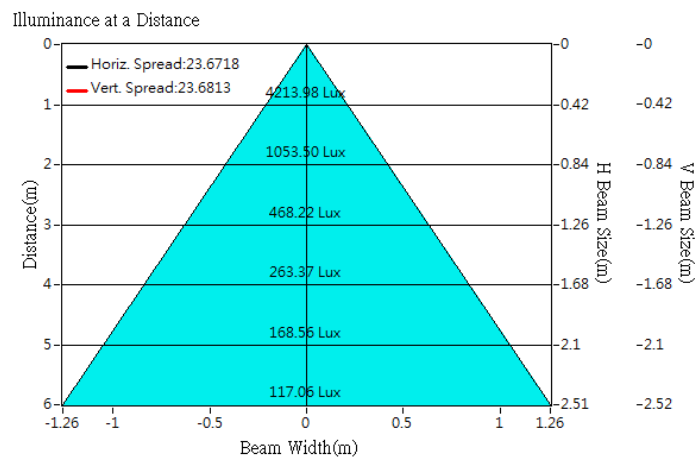



## Optical Characteristics

Model Number	CKO-CS18-035018-1303		<p>"H" definition</p>
LED	<b>CLU 710</b>		
LES / LED Size	Φ 8.5 mm		
FWHM (D50)	29°		
Field Angle (D10)	58°		
H (distance)	2.5mm		
Dimension	Φ =35 mm, Thickness=17.4 mm		
Luminous Flux	2685 lm	Measured @ 26.2 W	
Material	PC / UL94V2		

## cd/klm

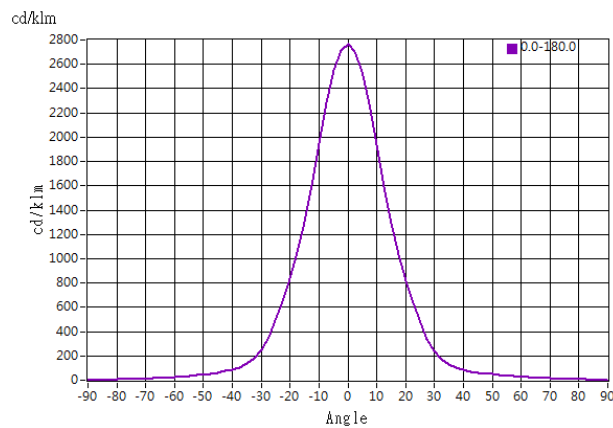

## Illuminance At Distances

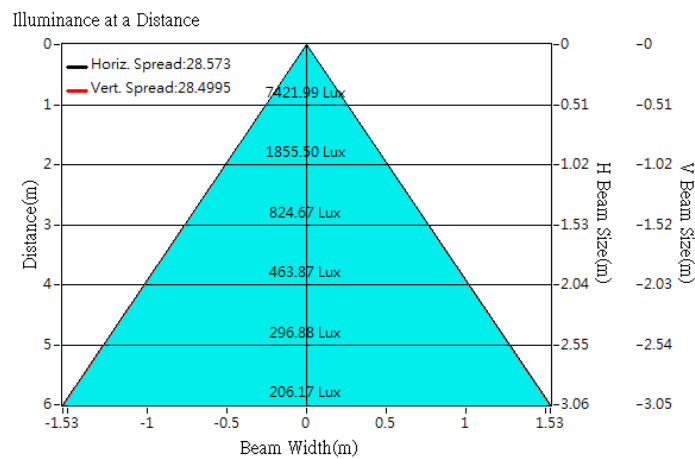



## Optical Characteristics

Model Number	CKO-CS18-035018-1303		<p>"H" definition</p>
LED	<b>CLU 711</b>		
LES / LED Size	Φ 8.5 mm		
FWHM (D50)	29°		
Field Angle (D10)	58°		
H (distance)	2.5mm		
Dimension	Φ =35 mm, Thickness=17.4 mm		
Luminous Flux	2857 lm	Measured @ 25.3 W	
Material	PC / UL94V2		

## cd/klm

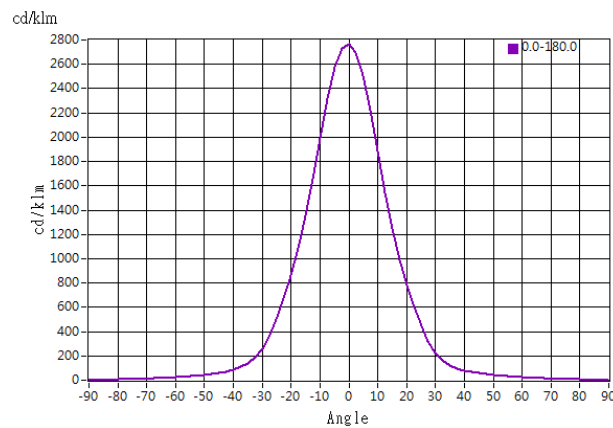

## Illuminance At Distances

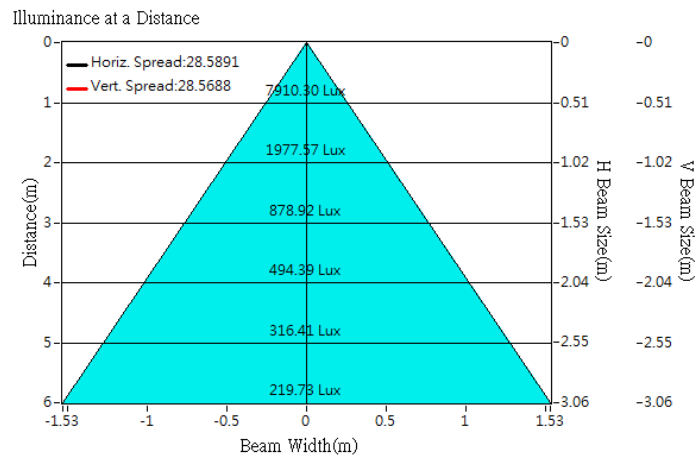



## Optical Characteristics

Model Number	CKO-CS18-035018-1303		<p>"H" definition</p> <p>LES CoB</p>
LED	CLU 026		
LES / LED Size	Φ 9.8 mm		
FWHM (D50)	31°		
Field Angle (D10)	64°		
H (distance)	2.5mm		
Dimension	Φ =35 mm, Thickness=17.4 mm		
Luminous Flux	1619 lm	Measured @ 12.5 W	
Material	PC / UL94V2		

## cd/klm

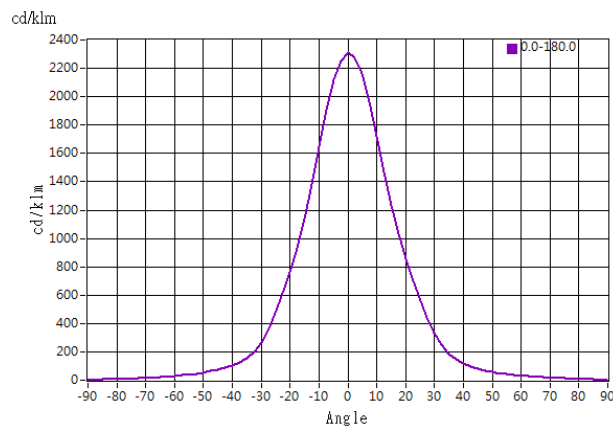

## Illuminance At Distances

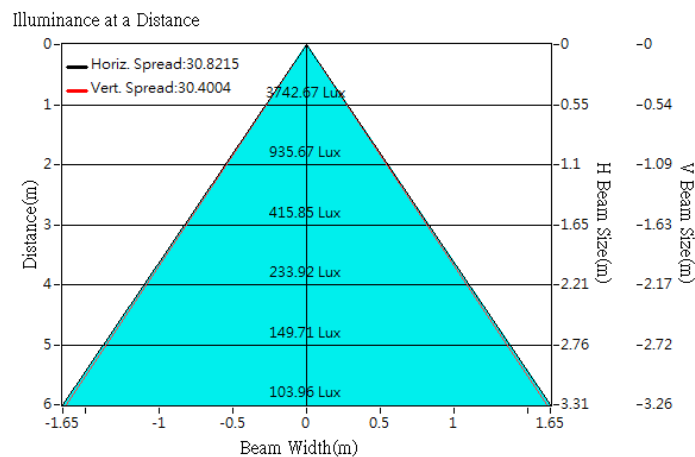



## Optical Characteristics

Model Number	CKO-CS18-035018-1303		<p>"H" definition</p> <p>LES CoB</p>
LED	CLU 028		
LES / LED Size	Φ 9.8 mm		
FWHM (D50)	30°		
Field Angle (D10)	63°		
H (distance)	2.5mm		
Dimension	Φ =35 mm, Thickness=17.4 mm		
Luminous Flux	1689 lm	Measured @ 12.5 W	
Material	PC / UL94V2		

## cd/klm

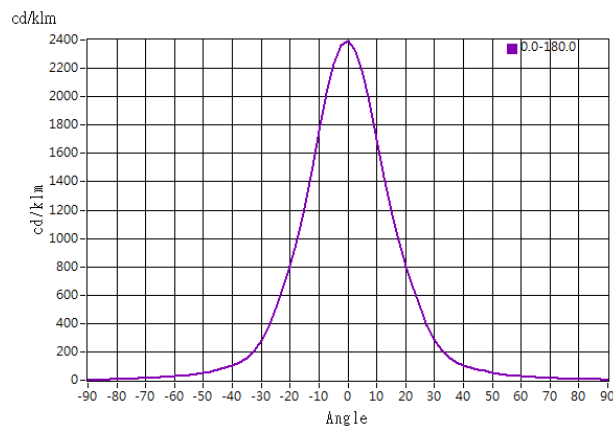

## Illuminance At Distances

