



Product Model Number

CKO-CS18-035018-1303

✓ Model Number Definitions

CKO-XXXX-XXXXXX-XXXX



- A. Chun Kuang Optics Corp. Product
- B. Product Type: product abbreviation
Ex:
CH→CoB High Intensity
CC→CoB Compact
CS→Soft Shading for CoB LED
HC→Holder for CoB LED

- C. Identity Code
- D. Lens / Fixture Size
Ex: 075026=Φ75mm / Thickness=26mm (round up)
- C. Serial Numbers

The lens datasheet is applicable for **Cree LED**, that manufactured by Chun Kuang Optics Corp.

✓ Dimensions (mm) : Φ35 x 17.4

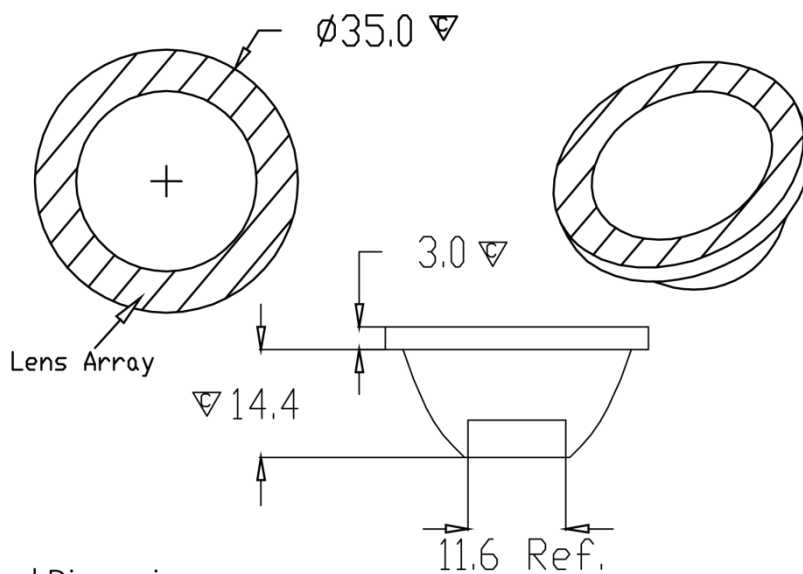

▽:Critical Dimension

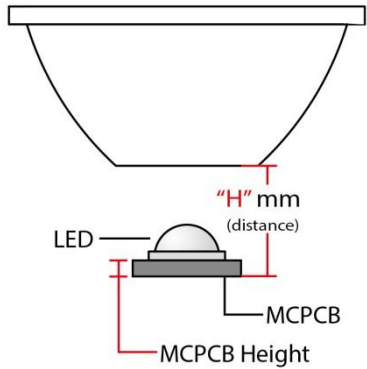

Optical Characteristics

Model Number	CKO-CS18-035018-1303		<p>"H" definition</p> 
LED	XHP 50.2		
LES / LED Size	5.0 x 5.0		
FWHM (D50)	23°		
Field Angle (D10)	46°		
H (distance)	2.5mm		
MCPCB Height	1.6 mm		
Dimension	Φ =35 mm, Thickness=17.4 mm		
Luminous Flux	987 lm	Measured @ 8.2 W	
Material	PC / UL94V2		

cd/klm

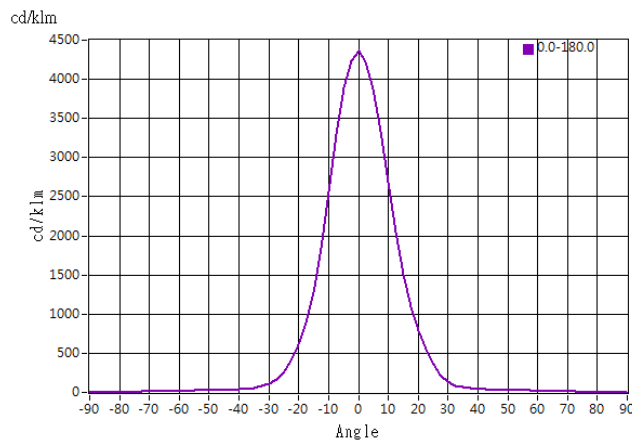

Illuminance At Distances

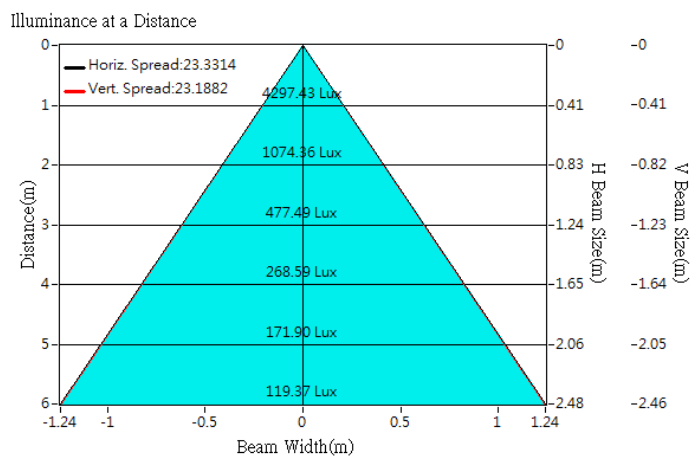

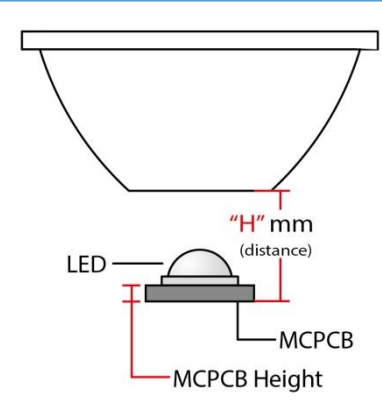

Optical Characteristics

Model Number	CKO-CS18-035018-1303		<p>"H" definition</p> 
LED	MHD-G		
LES / LED Size	7.0 x 7.0		
FWHM (D50)	26°		
Field Angle (D10)	52°		
H (distance)	2.5mm		
MCPCB Height	1.6 mm		
Dimension	Φ =35 mm, Thickness=17.4 mm		
Luminous Flux	1223 lm	Measured @ 12.6 W	
Material	PC / UL94V2		

cd/klm

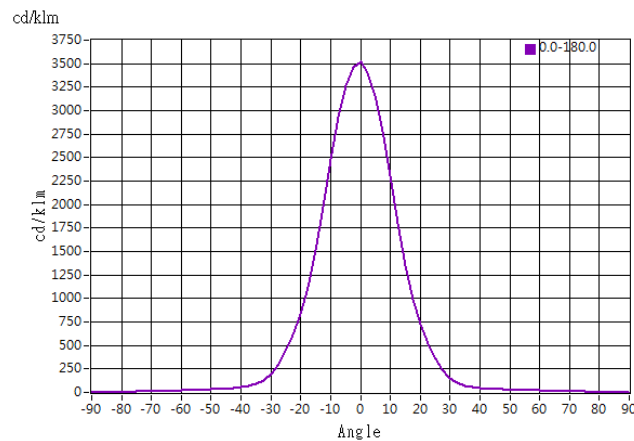

Illuminance At Distances

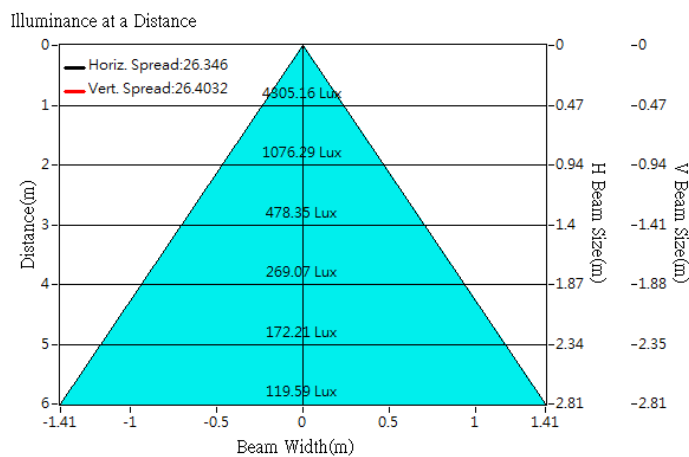



Optical Characteristics

Model Number	CKO-CS18-035018-1303		<p>"H" definition</p>
LED	CMA1303		
LES / LED Size	Φ 4.5 mm		
FWHM (D50)	21°		
Field Angle (D10)	42°		
H (distance)	2.5 mm		
Dimension	Φ =35 mm, Thickness= 17.4 mm		
Luminous Flux	474 lm	Measured @ 3.5 W	
Material	PC / UL94V2		

cd/klm

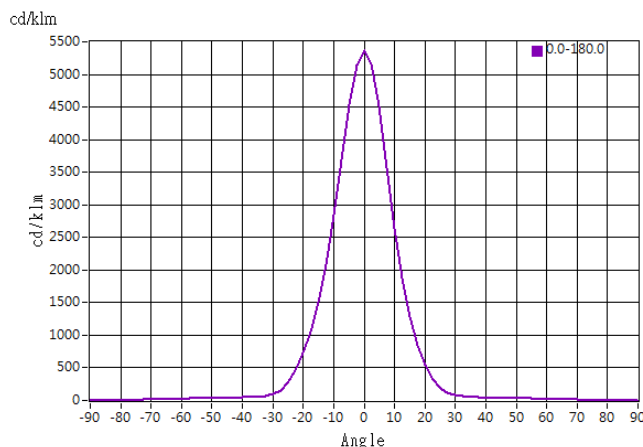

Illuminance At Distances

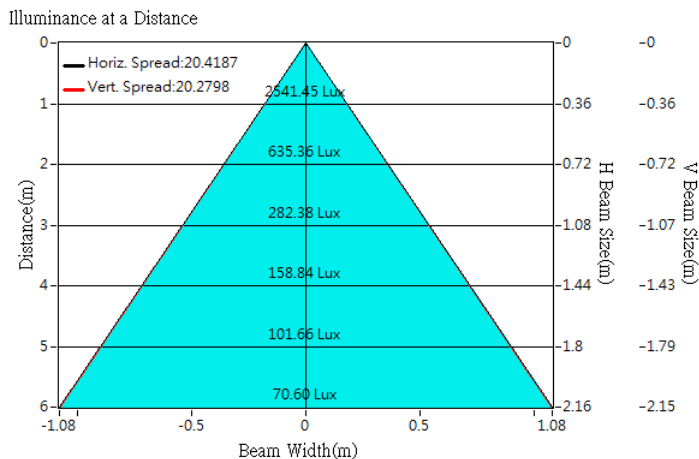



Optical Characteristics

Model Number	CKO-CS18-035018-1303		<p>"H" definition</p>
LED	CXA1304		
LES / LED Size	Φ 6 mm		
FWHM (D50)	23°		
Field Angle (D10)	47°		
H (distance)	2.5 mm		
Dimension	Φ =35 mm, Thickness= 17.4 mm		
Luminous Flux	414 lm	Measured @ 3.7 W	
Material	PC / UL94V2		

cd/klm

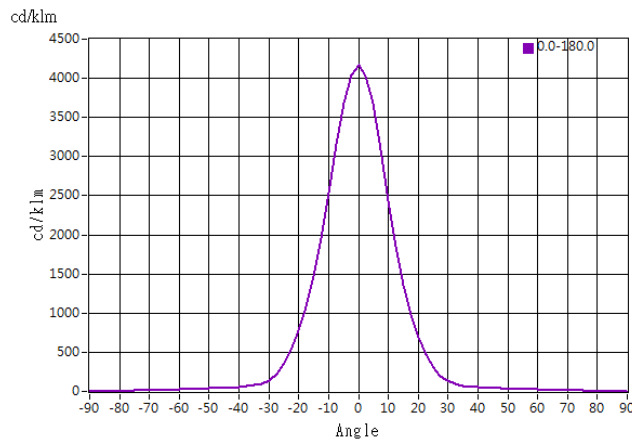

Illuminance At Distances

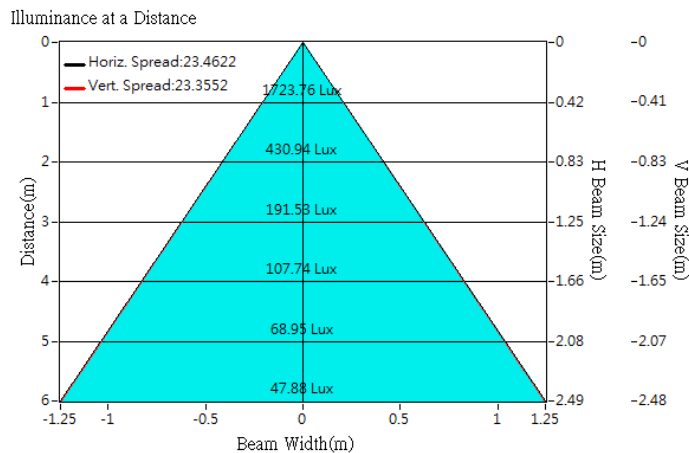



Optical Characteristics

Model Number	CKO-CS18-035018-1303		<p>"H" definition</p>
LED	CXB1304		
LES / LED Size	Φ 6 mm		
FWHM (D50)	23°		
Field Angle (D10)	47°		
H (distance)	2.5 mm		
Dimension	Φ =35 mm, Thickness= 17.4 mm		
Luminous Flux	456 lm	Measured @ 3.5 W	
Material	PC / UL94V2		

cd/klm

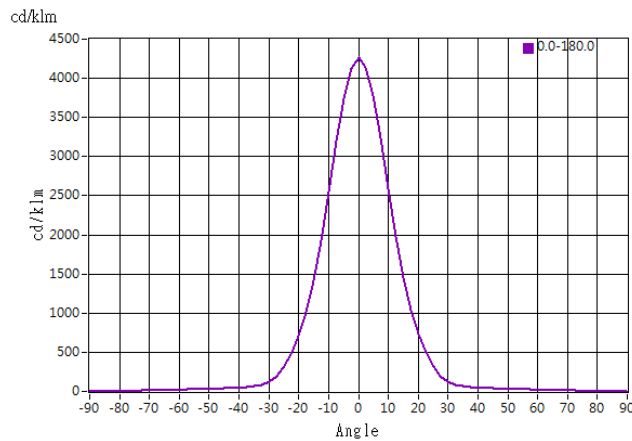

Illuminance At Distances

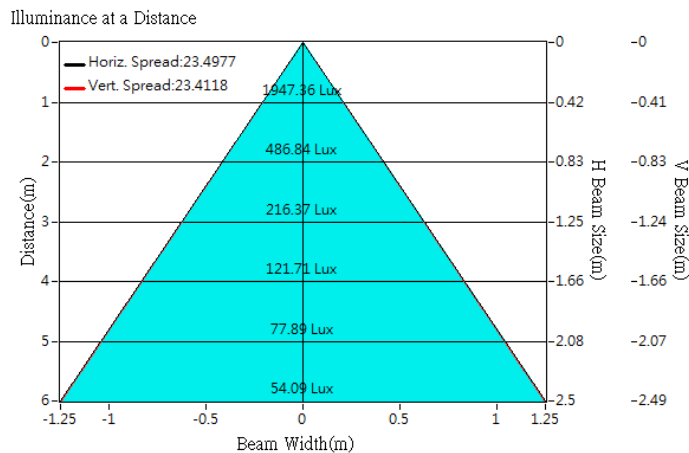



Optical Characteristics

Model Number	CKO-CS18-035018-1303		<p>"H" definition</p> <p>LES CoB</p>
LED	CMA1306		
LES / LED Size	Φ 6 mm		
FWHM (D50)	24°		
Field Angle (D10)	48°		
H (distance)	2.5 mm		
Dimension	Φ =35 mm, Thickness= 17.4 mm		
Luminous Flux	943 lm	Measured @ 7.3 W	
Material	PC / UL94V2		

cd/klm

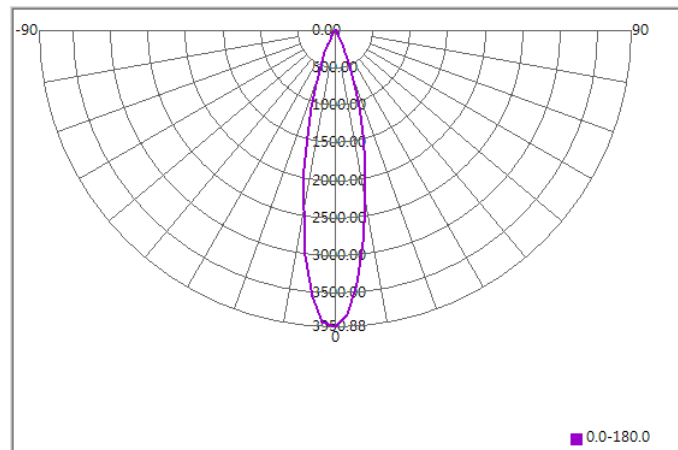

Illuminance At Distances

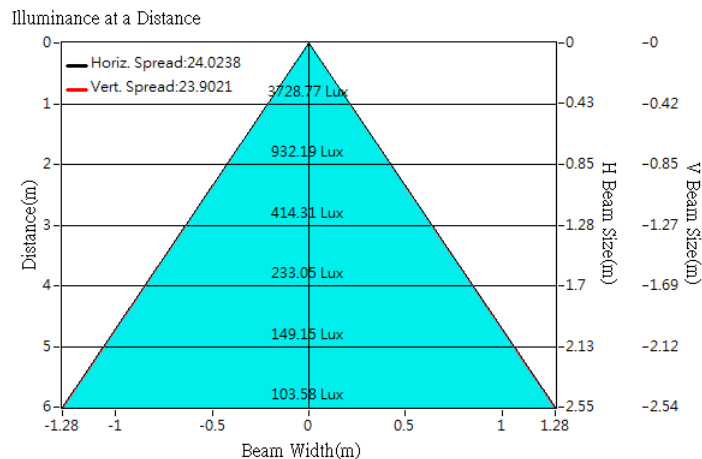



Optical Characteristics

Model Number	CKO-CS18-035018-1303		<p>"H" definition</p>
LED	CXB1310		
LES / LED Size	Φ 6 mm		
FWHM (D50)	24°		
Field Angle (D10)	48°		
H (distance)	2.5 mm		
Dimension	Φ =35 mm, Thickness= 17.4 mm		
Luminous Flux	1529 lm	Measured @ 12.1 W	
Material	PC / UL94V2		

cd/klm

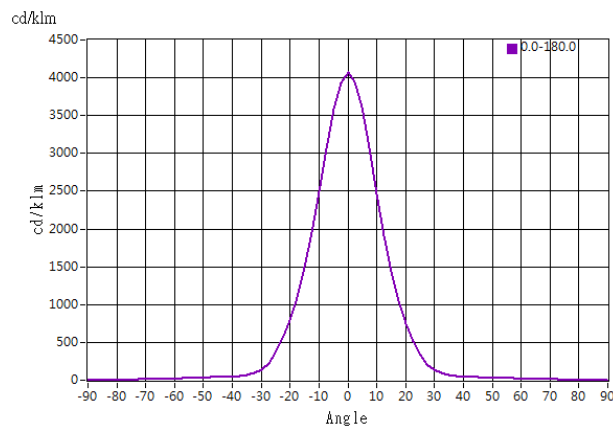

Illuminance At Distances

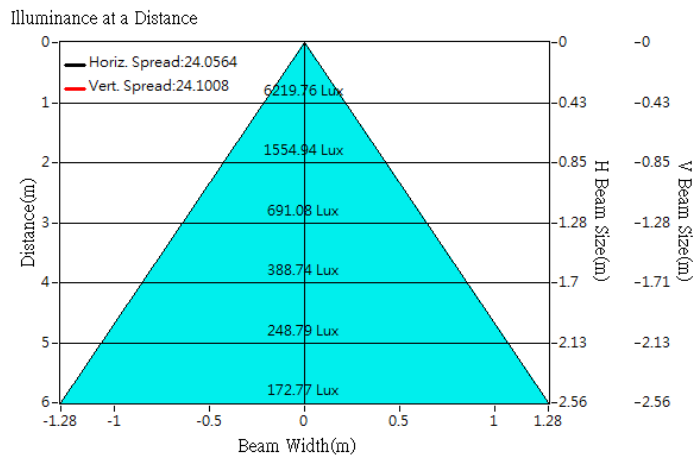

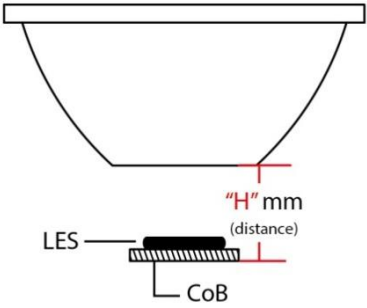

Optical Characteristics

Model Number	CKO-CS18-035018-1303		<p>"H" definition</p> 
LED	CXA1507		
LES / LED Size	Φ 9 mm		
FWHM (D50)	29°		
Field Angle (D10)	59°		
H (distance)	2.5 mm		
Dimension	Φ =35 mm, Thickness= 17.4 mm		
Luminous Flux	736 lm	Measured @ 7.6 W	
Material	PC / UL94V2		

cd/klm

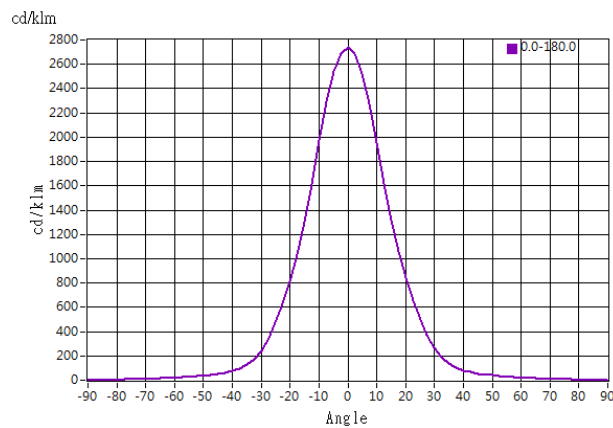

Illuminance At Distances

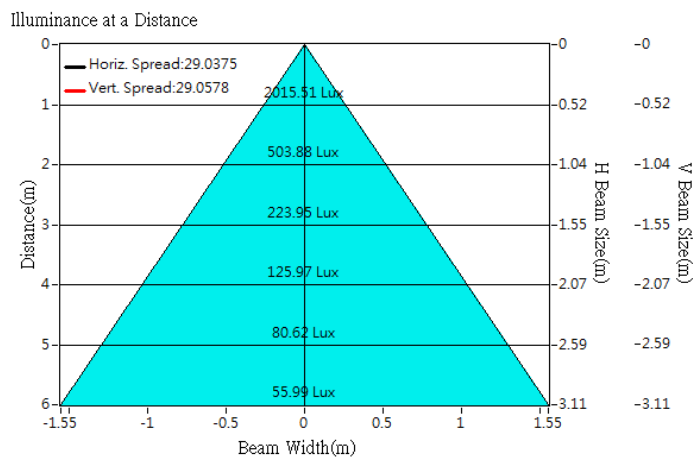

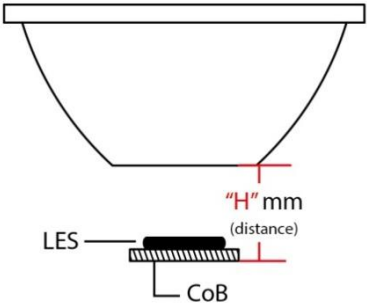

Optical Characteristics

Model Number	CKO-CS18-035018-1303		<p>"H" definition</p> 
LED	CXB1507		
LES / LED Size	Φ 9 mm		
FWHM (D50)	30°		
Field Angle (D10)	60°		
H (distance)	2.5 mm		
Dimension	Φ =35 mm, Thickness= 17.4 mm		
Luminous Flux	879 lm	Measured @ 7.2 W	
Material	PC / UL94V2		

cd/klm

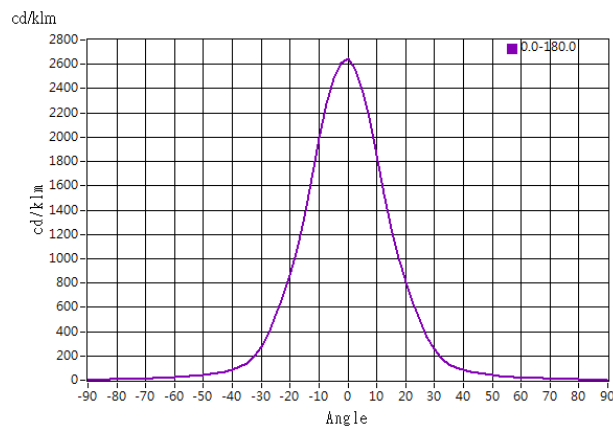

Illuminance At Distances

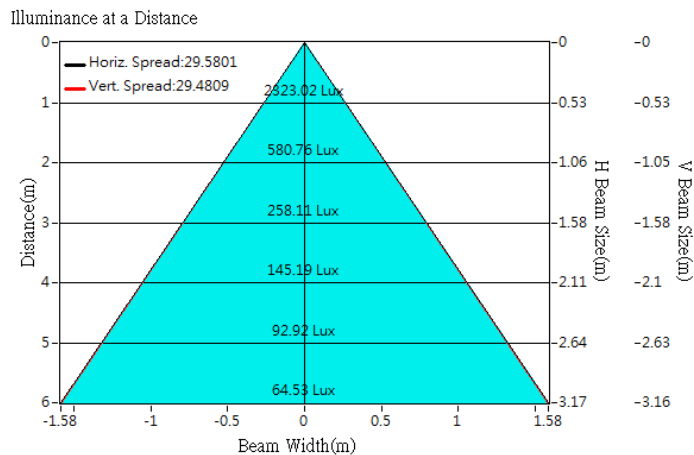

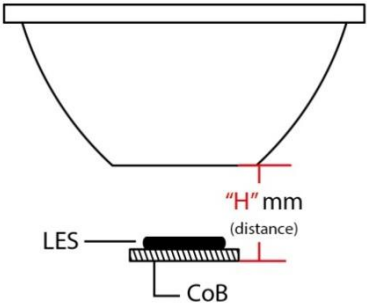

Optical Characteristics

Model Number	CKO-CS18-035018-1303		<p>"H" definition</p> 
LED	CXA 1510		
LES / LED Size	Φ 9 mm		
FWHM (D50)	29°		
Field Angle (D10)	60°		
H (distance)	2.5 mm		
Dimension	Φ =35 mm, Thickness= 17.4 mm		
Luminous Flux	1061 lm	Measured @ 8.9 W	
Material	PC / UL94V2		

cd/klm

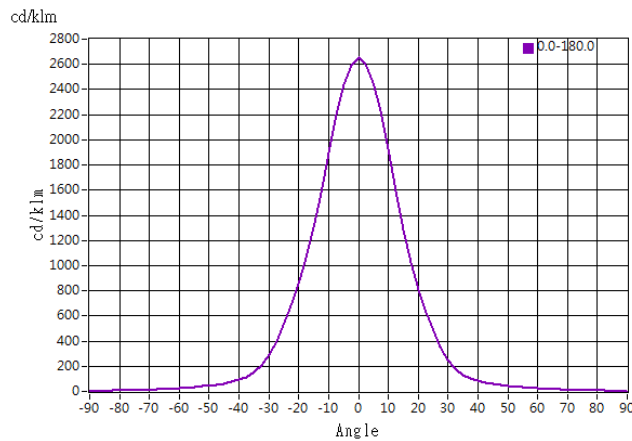

Illuminance At Distances

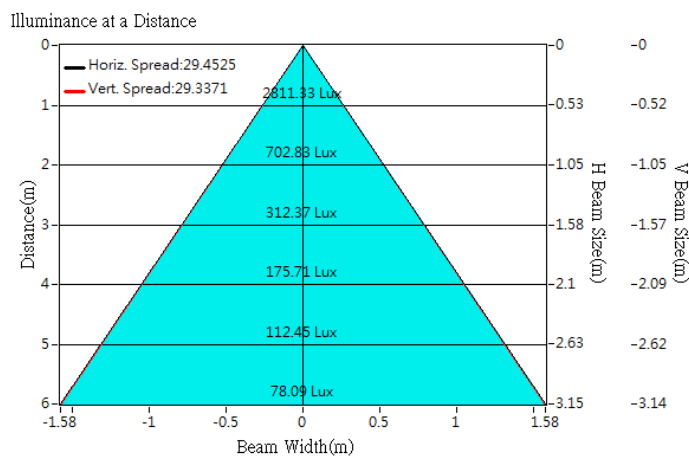



Optical Characteristics

Model Number	CKO-CS18-035018-1303		<p>"H" definition</p>
LED	CXA1512		
LES / LED Size	Φ 9 mm		
FWHM (D50)	28°		
Field Angle (D10)	58°		
H (distance)	2.5 mm		
Dimension	Φ =35 mm, Thickness= 17.4 mm		
Luminous Flux	1266 lm	Measured @ 13.5 W	
Material	PC / UL94V2		

cd/klm

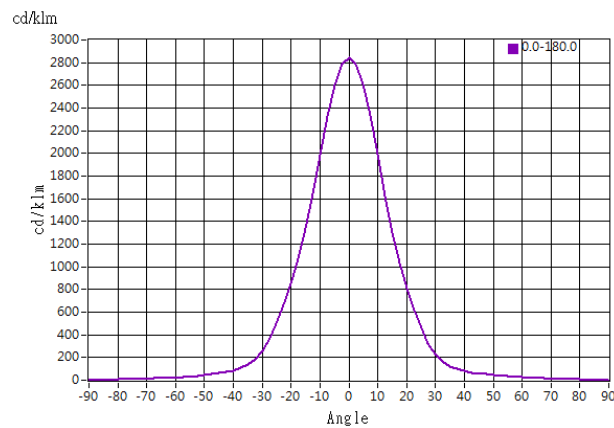

Illuminance At Distances

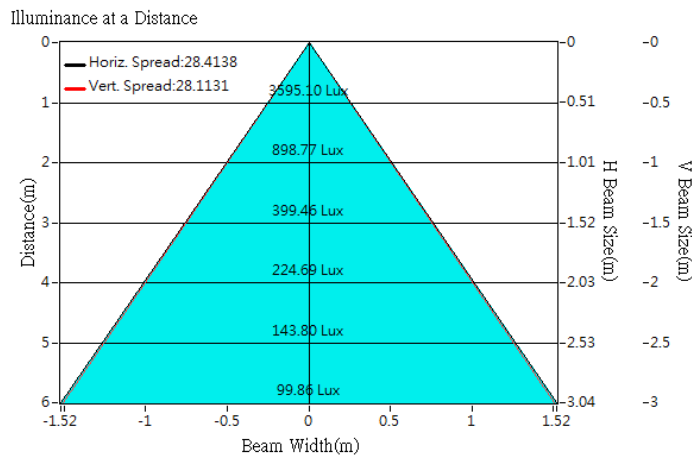

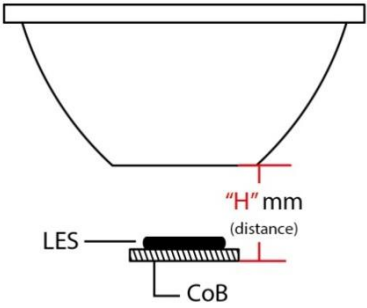

Optical Characteristics

Model Number	CKO-CS18-035018-1303		<p>"H" definition</p> 
LED	CXB1512		
LES / LED Size	Φ 9 mm		
FWHM (D50)	29°		
Field Angle (D10)	60°		
H (distance)	2.5 mm		
Dimension	Φ =35 mm, Thickness= 17.4 mm		
Luminous Flux	1478 lm	Measured @ 12.1 W	
Material	PC / UL94V2		

cd/klm

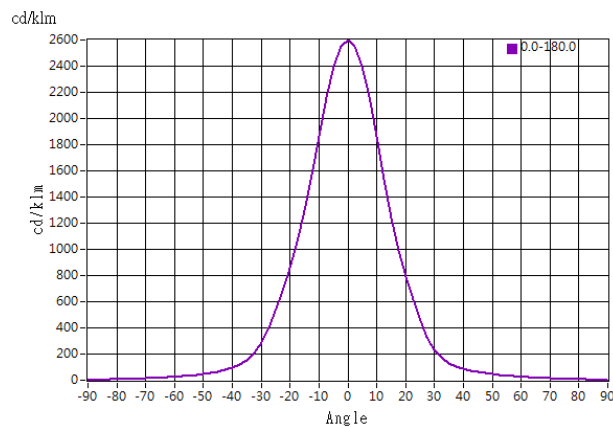

Illuminance At Distances

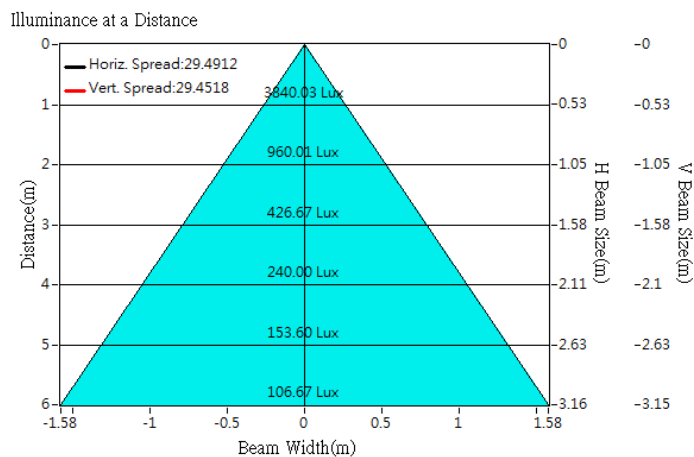



Optical Characteristics

Model Number	CKO-CS18-035018-1303		<p>"H" definition</p> <p>LES CoB</p>
LED	CMA1516		
LES / LED Size	Φ 9 mm		
FWHM (D50)	30°		
Field Angle (D10)	62°		
H (distance)	2.5 mm		
Dimension	Φ =35 mm, Thickness= 17.4 mm		
Luminous Flux	2040 lm	Measured @ 15.5 W	
Material	PC / UL94V2		

cd/klm

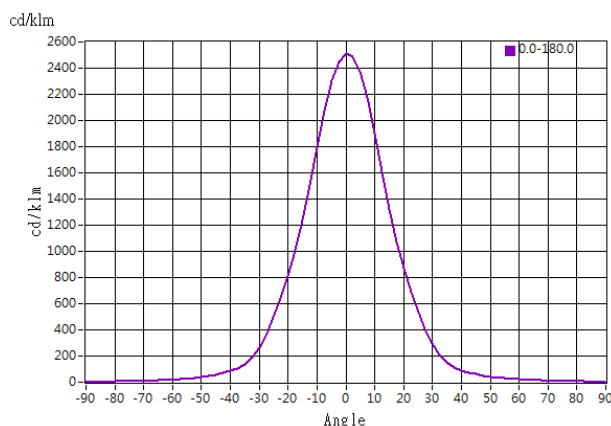

Illuminance At Distances

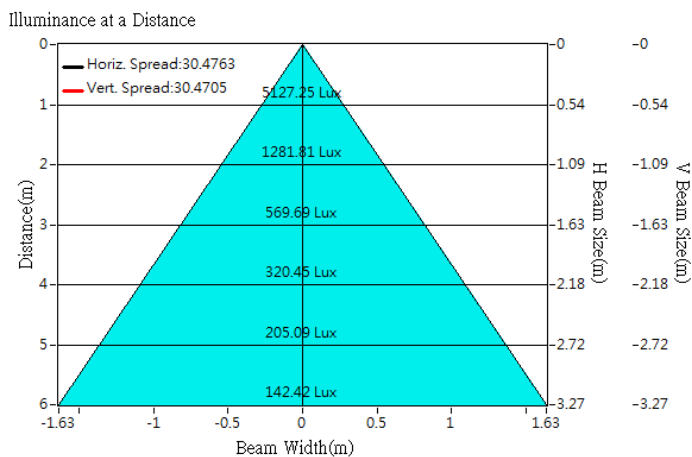



Optical Characteristics

Model Number	CKO-CS18-035018-1303		<p>"H" definition</p> <p>LES CoB</p>
LED	CXB1520		
LES / LED Size	Φ 9 mm		
FWHM (D50)	31°		
Field Angle (D10)	62°		
H (distance)	2.5 mm		
Dimension	Φ =35 mm, Thickness= 17.4 mm		
Luminous Flux	2163 lm	Measured @ 16.6 W	
Material	PC / UL94V2		

cd/klm

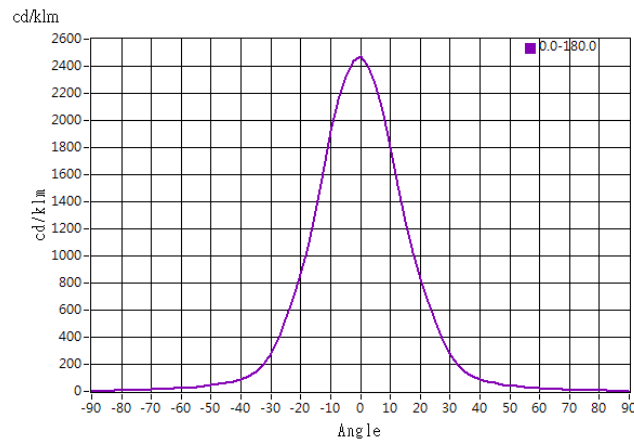

Illuminance At Distances

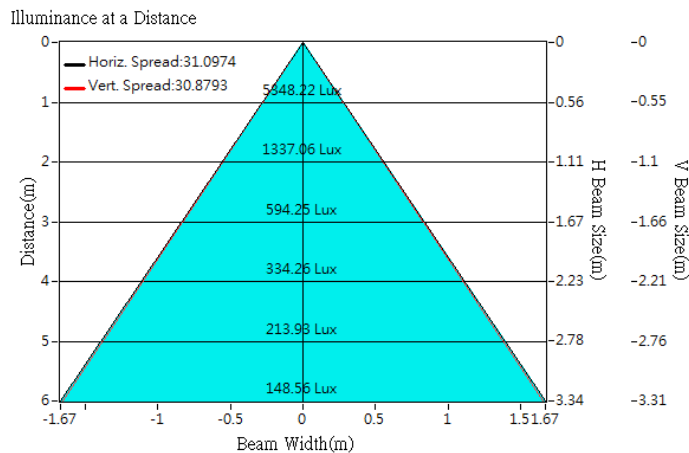



Optical Characteristics

Model Number	CKO-CS18-035018-1303		<p>"H" definition</p>
LED	CMT1407		
LES / LED Size	Φ 9.8 mm		
FWHM (D50)	30°		
Field Angle (D10)	62°		
H (distance)	2.5 mm		
Dimension	Φ =35 mm, Thickness= 17.4 mm		
Luminous Flux	900 lm	Measured @ 7.0 W	
Material	PC / UL94V2		

cd/klm

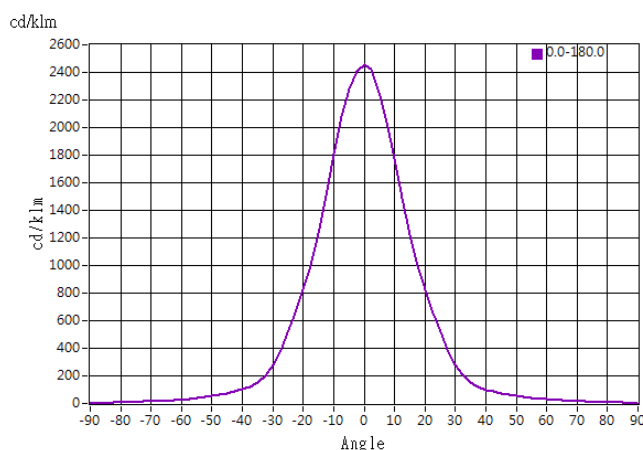

Illuminance At Distances

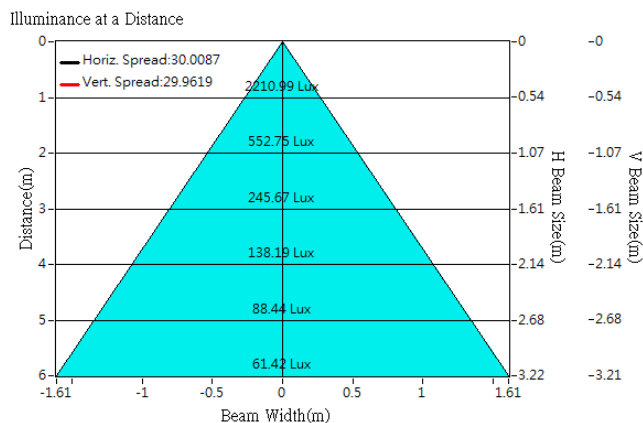



Optical Characteristics

Model Number	CKO-CS18-035018-1303		<p>"H" definition</p> <p>LES CoB</p>
LED	CMT1412		
LES / LED Size	Φ 9.8 mm		
FWHM (D50)	31°		
Field Angle (D10)	63°		
H (distance)	2.5 mm		
Dimension	Φ =35 mm, Thickness= 17.4 mm		
Luminous Flux	1497 lm	Measured @ 12.2 W	
Material	PC / UL94V2		

cd/klm

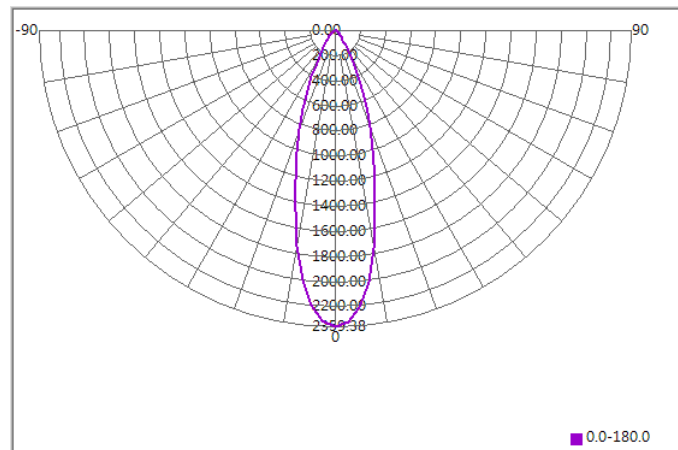

Illuminance At Distances

