



Product Model Number

CKO-CS18-035018-1306

✓ Model Number Definitions

CKO-XXXX-XXXXXX-XXXX



- A. Chun Kuang Optics Corp. Product
- B. Product Type: product abbreviation
Ex:
CH→CoB High Intensity
CC→CoB Compact
CS→Soft Shading for CoB LED
HC→Holder for CoB LED

- C. Identity Code
- D. Lens / Fixture Size
Ex: 075026=Φ75mm / Thickness=26mm (round up)
- C. Serial Numbers

The lens datasheet is applicable for **Lumileds LED**, that manufactured by Chun Kuang Optics Corp.

✓ Dimensions (mm) : Φ35 x 17.4

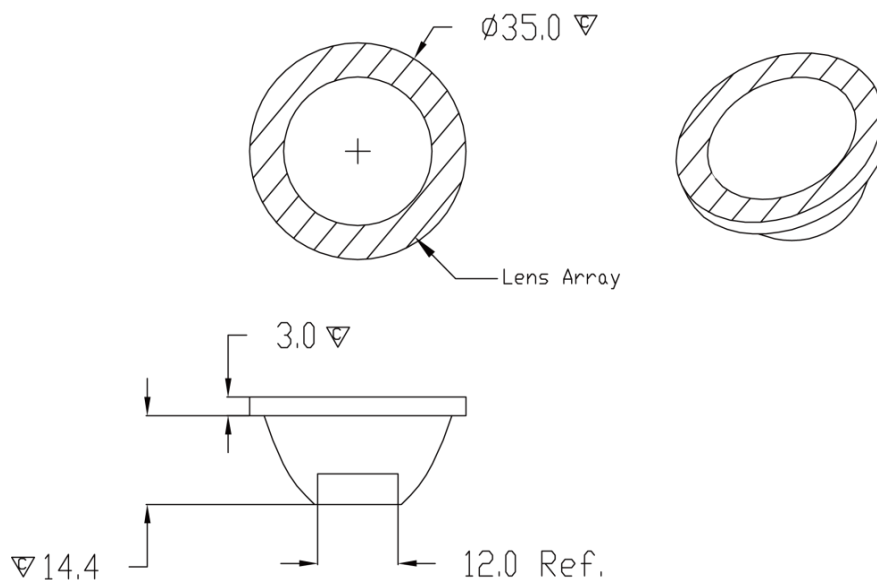

▽:Critical Dimension



Optical Characteristics

Model Number	CKO-CS18-035018-1306		<p>"H" definition</p>
LED	LUXEON 1202 HD		
LES / LED Size	Φ 6.5 mm		
FWHM (D50)	30°		
Field Angle (D10)	56°		
H (distance)	2.5 mm		
Dimension	Φ =35 mm, Thickness= 17.4 mm		
Luminous Flux	1057 lm	Measured @ 10.9 W	
Material	PC / UL94V2		

cd/klm

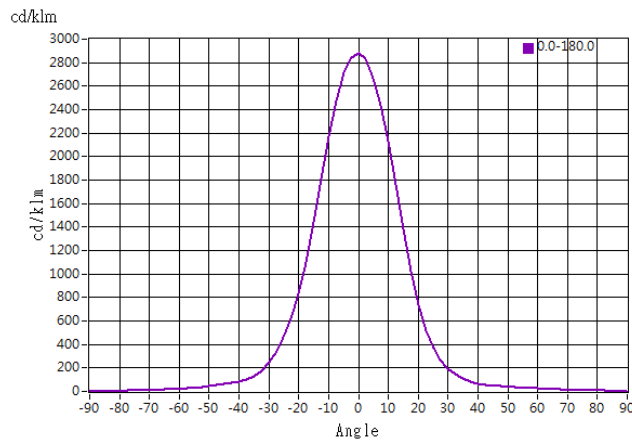

Illuminance At Distances

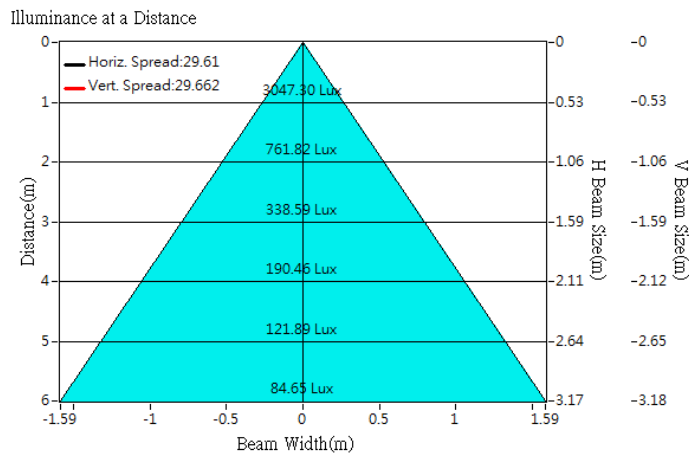



Optical Characteristics

Model Number	CKO-CS18-035018-1306		<p>"H" definition</p>
LED	LUXEON 1203		
LES / LED Size	Φ 9 mm		
FWHM (D50)	34°		
Field Angle (D10)	63°		
H (distance)	2.5 mm		
Dimension	Φ =35 mm, Thickness= 17.4 mm		
Luminous Flux	759 lm	Measured @ 11.1 W	
Material	PC / UL94V2		

cd/klm

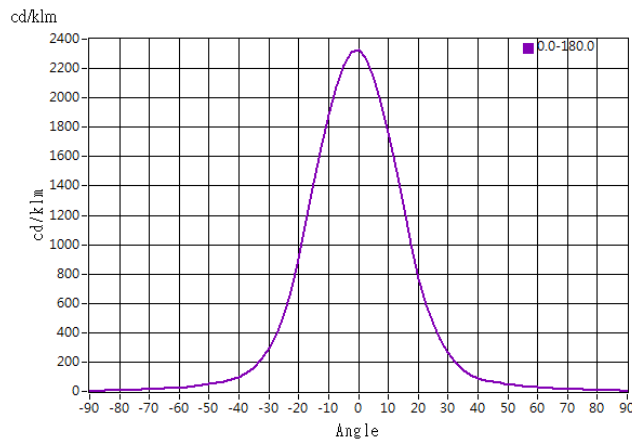

Illuminance At Distances

