



## Product Model Number

**CKO-CS18-035018-1306**

### ✓ Model Number Definitions

**CKO-XXXX-XXXXXX-XXXX**



- A. Chun Kuang Optics Corp. Product
- B. Product Type: product abbreviation  
Ex:  
CH→CoB High Intensity  
CC→CoB Compact  
CS→Soft Shading for CoB LED  
HC→Holder for CoB LED

- C. Identity Code
- D. Lens / Fixture Size  
Ex: 075026=Φ75mm / Thickness=26mm (round up)
- C. Serial Numbers

The lens datasheet is applicable for **Luminus LED**, that manufactured by Chun Kuang Optics Corp.

### ✓ Dimensions (mm) : Φ35 x 17.4

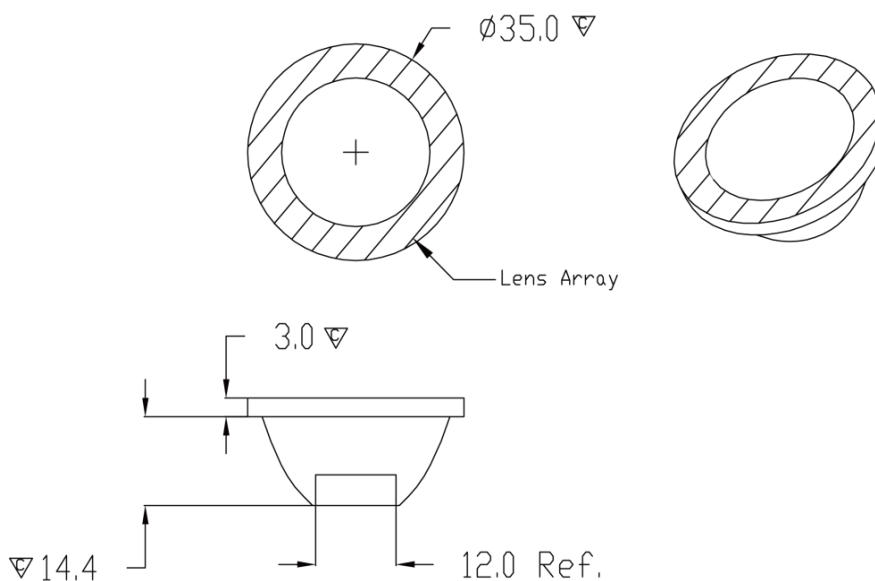

▽:Critical Dimension





## Optical Characteristics

Model Number	CKO-CS18-035018-1306		<p>"H" definition</p> <p>LES CoB</p>
LED	<b>CXM-3-AC40</b>		
LES / LED Size	Φ 3.5 mm		
FWHM (D50)	22°		
Field Angle (D10)	44°		
H (distance)	2.5 mm		
Dimension	Φ =35 mm, Thickness= 17.4 mm		
Luminous Flux	294 lm	Measured @ 2.8 W	
Material	PC / UL94V2		

## cd/klm

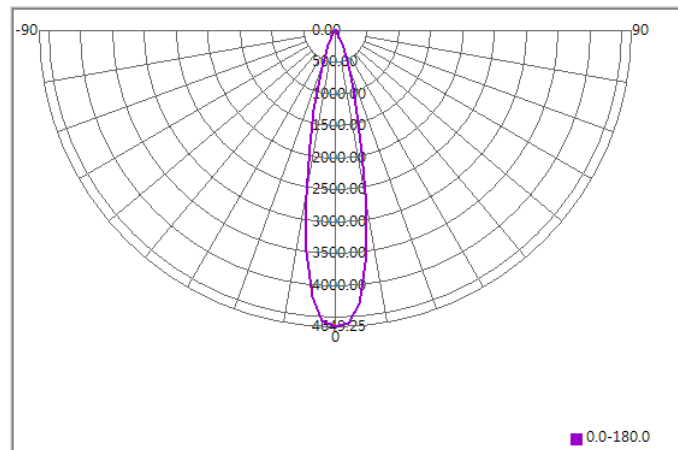

## Illuminance At Distances

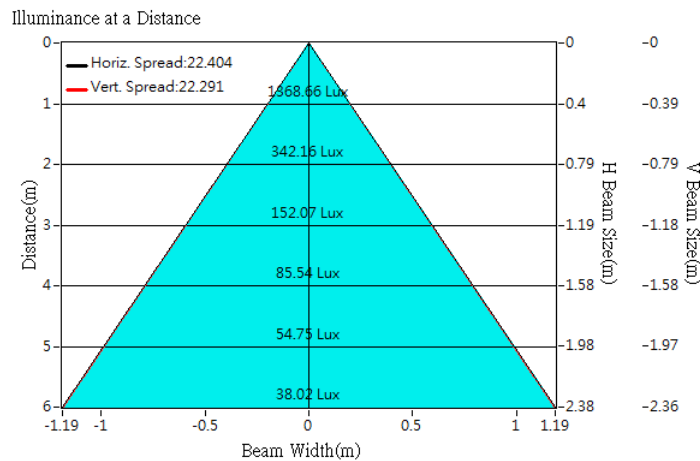



## Optical Characteristics

Model Number	CKO-CS18-035018-1306		<p>"H" definition</p> <p>LES CoB</p>
LED	<b>CXM-4-AC40</b>		
LES / LED Size	Φ 4.5 mm		
FWHM (D50)	26°		
Field Angle (D10)	48°		
H (distance)	2.5 mm		
Dimension	Φ =35 mm, Thickness= 17.4 mm		
Luminous Flux	476 lm	Measured @ 4.0 W	
Material	PC / UL94V2		

## cd/klm

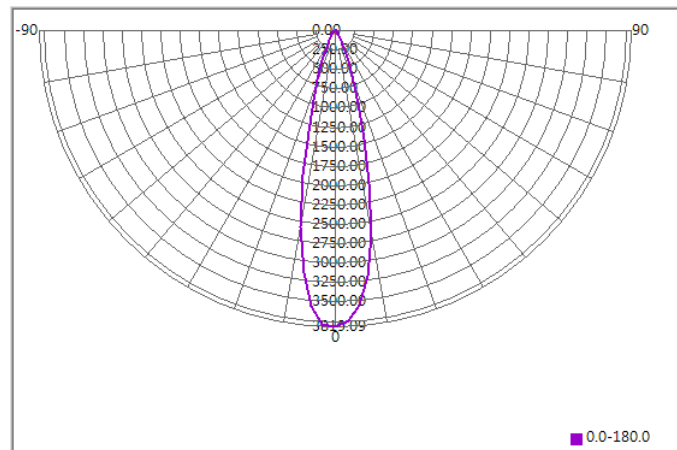

## Illuminance At Distances

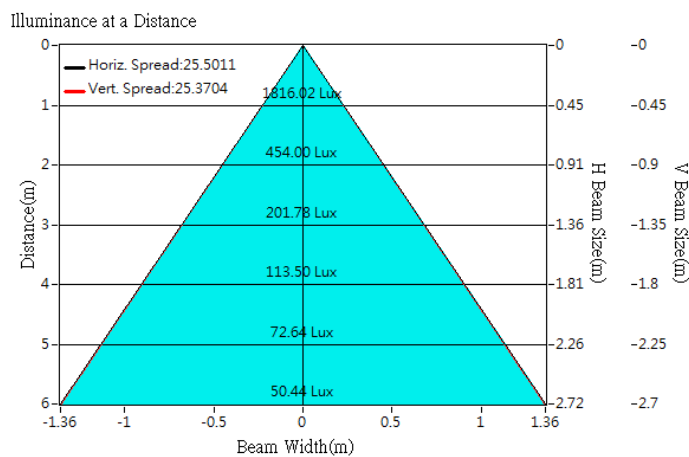



## Optical Characteristics

Model Number	CKO-CS18-035018-1306		<p>"H" definition</p> <p>LES CoB</p>
LED	<b>CXM-6-AC40</b>		
LES / LED Size	Φ 6.3 mm		
FWHM (D50)	30°		
Field Angle (D10)	56°		
H (distance)	2.5 mm		
Dimension	Φ =35 mm, Thickness= 17.4 mm		
Luminous Flux	725 lm	Measured @ 5.1 W	
Material	PC / UL94V2		

## cd/klm

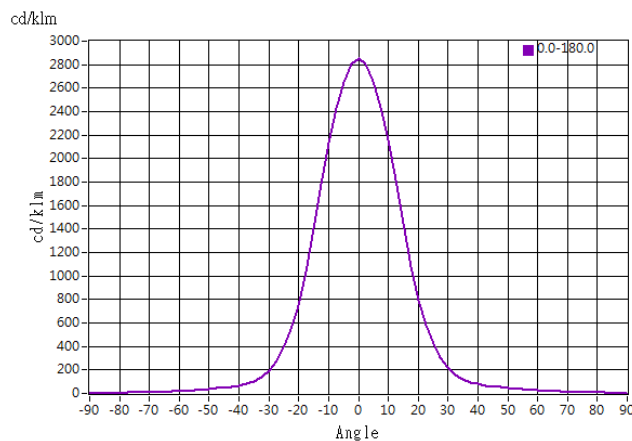

## Illuminance At Distances

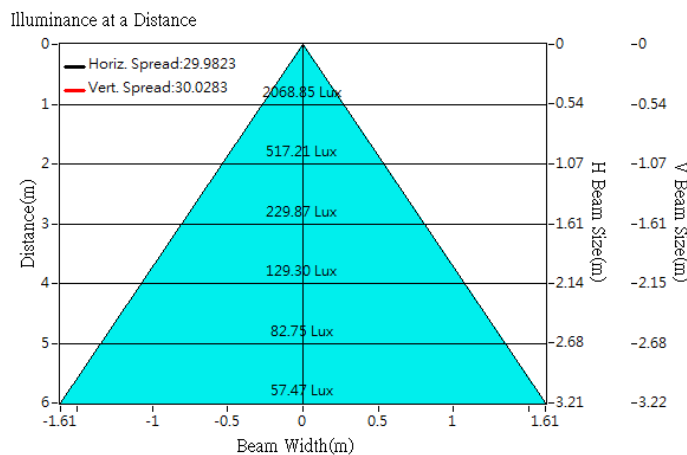



## Optical Characteristics

Model Number	CKO-CS18-035018-1306		<p>"H" definition</p>
LED	<b>CXM-9-AC30</b>		
LES / LED Size	Φ 9.6 mm		
FWHM (D50)	35°		
Field Angle (D10)	66°		
H (distance)	2.5 mm		
Dimension	Φ =35 mm, Thickness= 17.4 mm		
Luminous Flux	1391 lm	Measured @ 12.1 W	
Material	PC / UL94V2		

## cd/klm

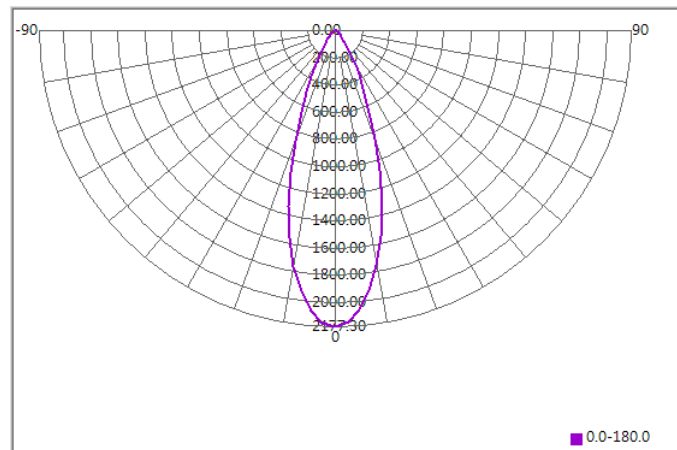

## Illuminance At Distances

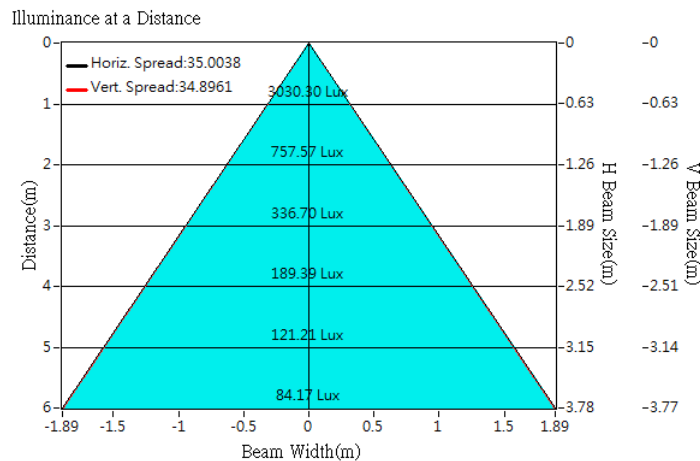



## Optical Characteristics

Model Number	CKO-CS18-035018-1306		<p>"H" definition</p> <p>LES CoB</p>
LED	<b>CXM-9-AC40</b>		
LES / LED Size	Φ 9.8 mm		
FWHM (D50)	36°		
Field Angle (D10)	68°		
H (distance)	2.5 mm		
Dimension	Φ =35 mm, Thickness= 17.4 mm		
Luminous Flux	1374 lm	Measured @ 12.3 W	
Material	PC / UL94V2		

## cd/klm

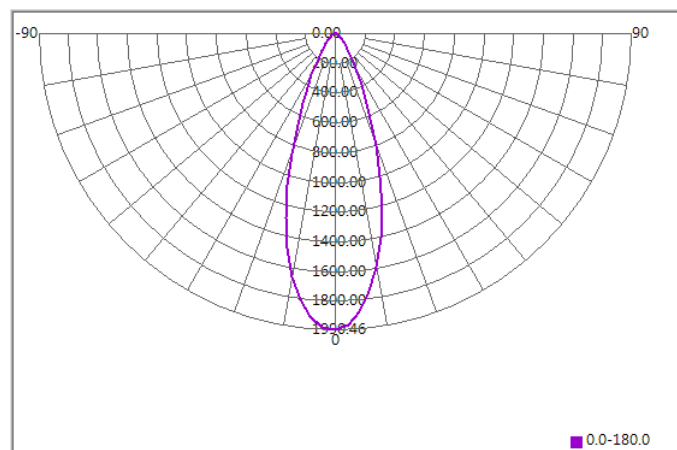

## Illuminance At Distances

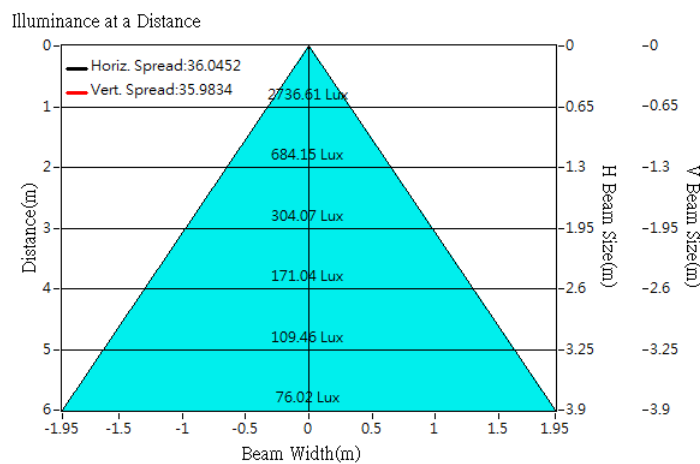



## Optical Characteristics

Model Number	CKO-CS18-035018-1306		<p>"H" definition</p> <p>LES CoB</p>
LED	<b>CXM-11-AC30</b>		
LES / LED Size	Φ 11.7 mm		
FWHM (D50)	39°		
Field Angle (D10)	74°		
H (distance)	2.5 mm		
Dimension	Φ =35 mm, Thickness= 17.4 mm		
Luminous Flux	1718 lm	Measured @ 15.0 W	
Material	PC / UL94V2		

## cd/klm

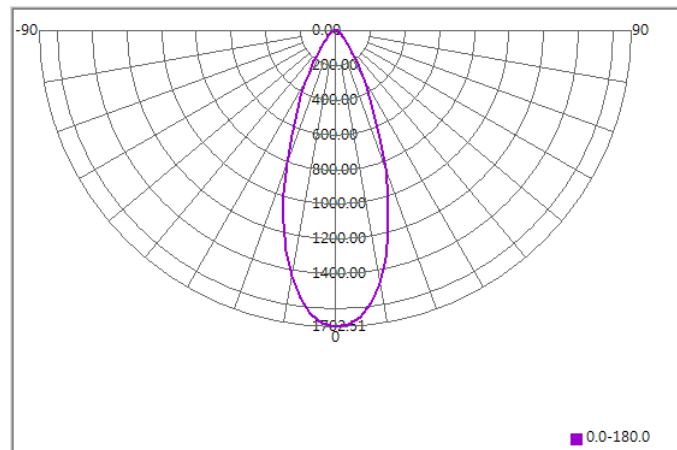

## Illuminance At Distances

