



## Product Model Number

CKO-CU15-034009-9907

### ✓ Model Number Definitions

**CKO-XXXX-XXXXXX-XXXX**



- A. Chun Kuang Optics Corp. Product
- B. Product Type: product abbreviation  
Ex:  
CH→CoB High Intensity  
CC→CoB Compact  
CS→Soft Shading for CoB LED  
HC→Holder for CoB LED

- C. Identity Code
- D. Lens / Fixture Size  
Ex: 075026=Φ75mm / Thickness=26mm (round up)
- C. Serial Numbers

The lens datasheet is applicable for **Ciziten LED**, that manufactured by Chun Kuang Optics Corp.

### ✓ Dimensions (mm) : Φ33.9 x 8.2

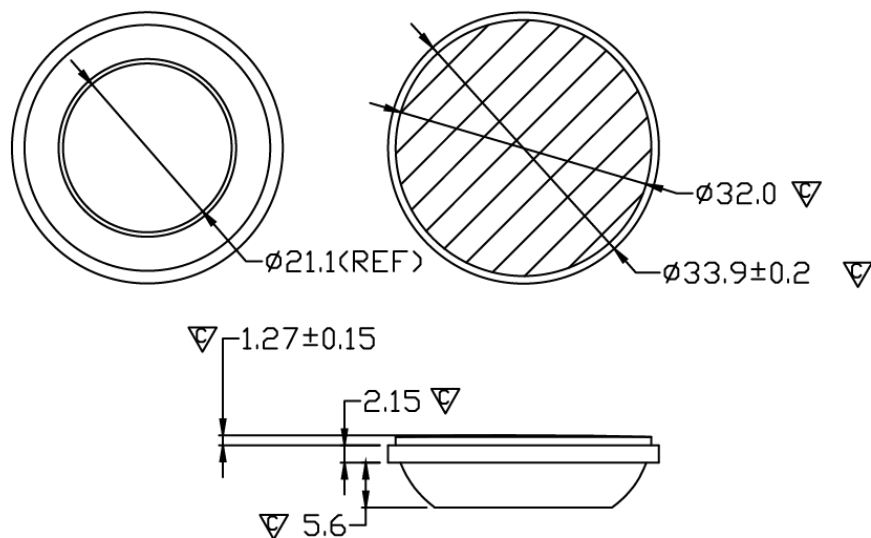

▽:Critical Dimension





## Optical Characteristics

Model Number	CKO-CU15-034009-9907		<p>"H" definition</p> <p>LES CoB</p>
LED	<b>CLU 701</b>		
LES / LED Size	Φ 6 mm		
FWHM (D50)	33°		
Field Angle (D10)	57°		
H (distance)	2.4 mm		
Dimension	Φ =33.9 mm, Thickness= 8.2 mm		
Luminous Flux	1107 lm	Measured @ 10.9 W	
Material	PC / UL94V2		

## cd/klm

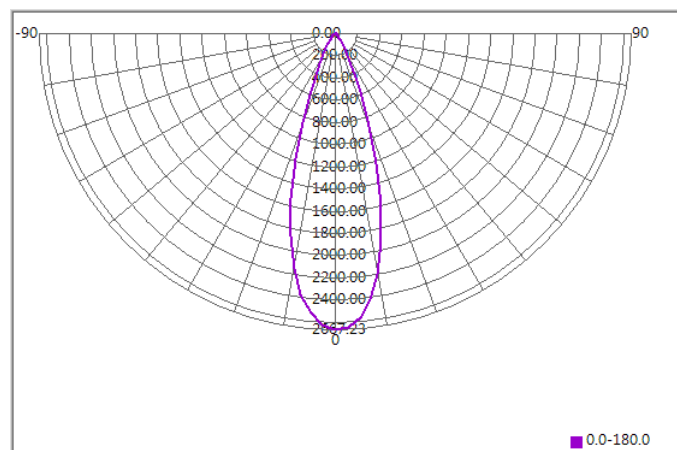

## Illuminance At Distances

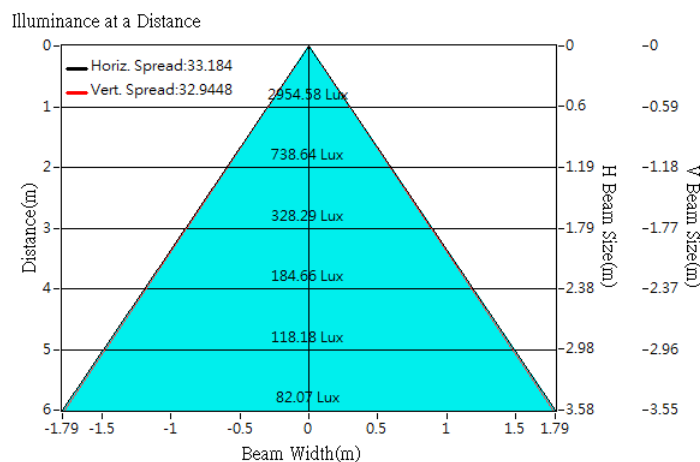



## Optical Characteristics

Model Number	CKO-CU15-034009-9907	<p>"H" definition</p>	
LED	<b>CLU 700</b>		
LES / LED Size	Φ 6 mm		
FWHM (D50)	35°		
Field Angle (D10)	60°		
H (distance)	2.4 mm		
Dimension	Φ =33.9 mm, Thickness= 8.2 mm		
Luminous Flux	1457 lm		Measured @ 14.5 W
Material	PC / UL94V2		

## cd/klm

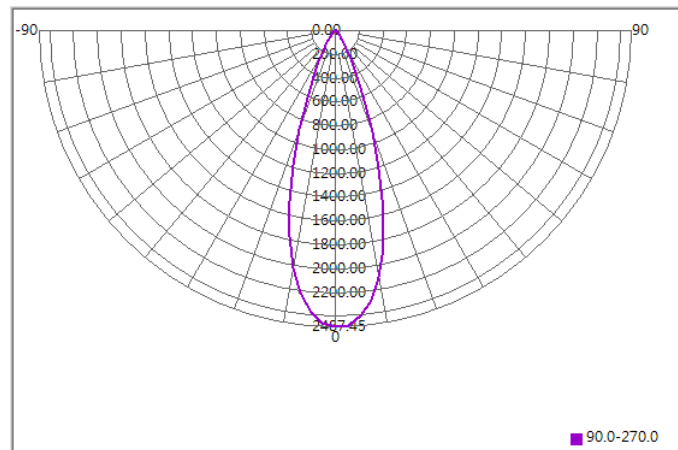

## Illuminance At Distances

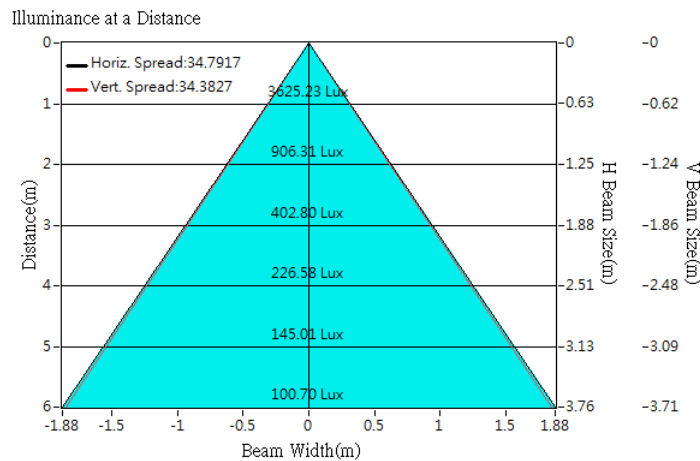



## Optical Characteristics

Model Number	CKO-CU15-034009-9907		<p>"H" definition</p> <p>LES CoB</p>
LED	<b>CLU 711</b>		
LES / LED Size	Φ 8.5 mm		
FWHM (D50)	39°		
Field Angle (D10)	68°		
H (distance)	2.4 mm		
Dimension	Φ =33.9 mm, Thickness= 8.2 mm		
Luminous Flux	2963 lm	Measured @ 25.6 W	
Material	PC / UL94V2		

## cd/klm

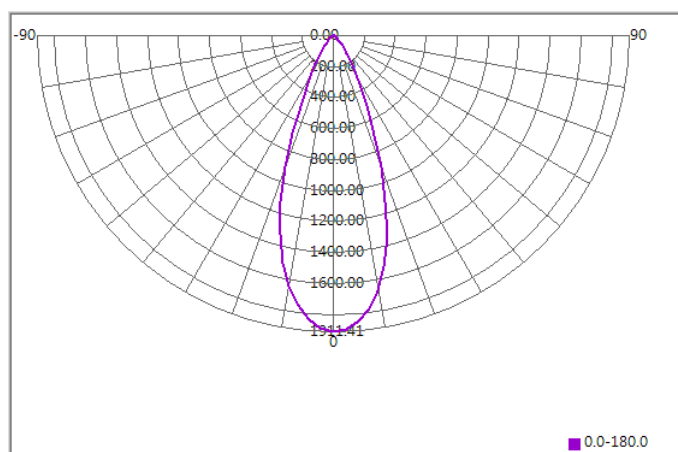

## Illuminance At Distances

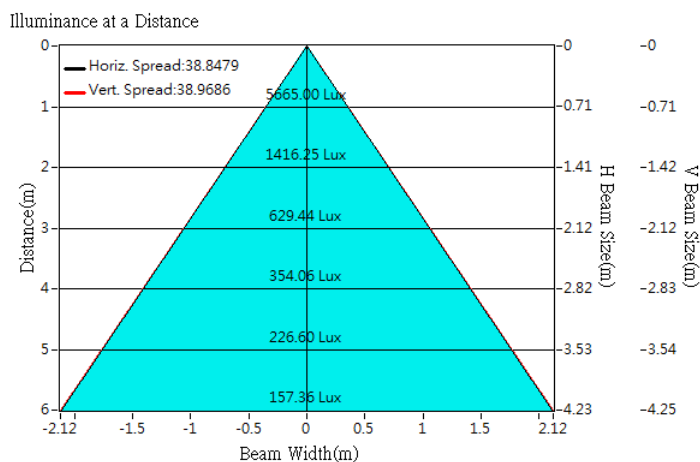



## Optical Characteristics

Model Number	CKO-CU15-034009-9907	<p>"H" definition</p> <p>LES CoB</p>
LED	<b>CLU 710</b>	
LES / LED Size	Φ 8.5 mm	
FWHM (D50)	40°	
Field Angle (D10)	70°	
H (distance)	2.4 mm	
Dimension	Φ =33.9 mm, Thickness= 8.2 mm	
Luminous Flux	2796 lm	
Material	PC / UL94V2	

## cd/klm

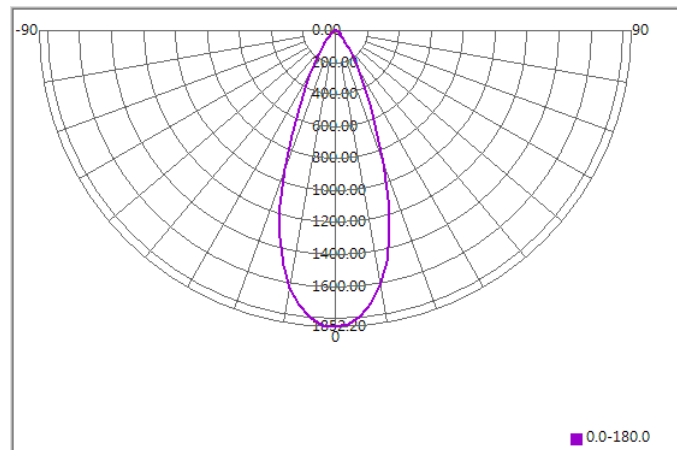

## Illuminance At Distances

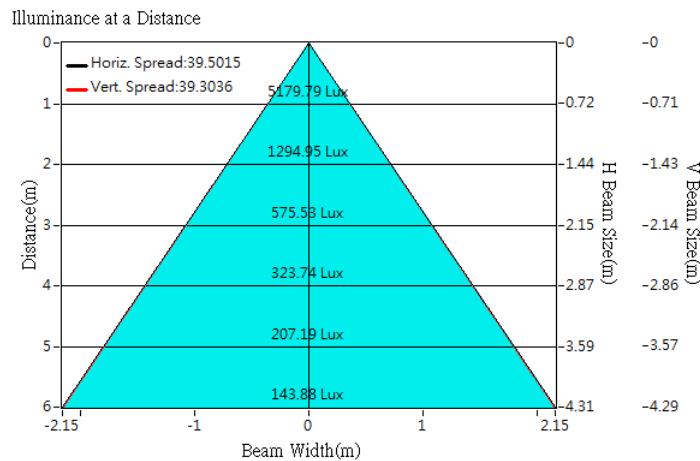



## Optical Characteristics

Model Number	CKO-CU15-034009-9907	<p>"H" definition</p>	
LED	<b>CLU 028</b>		
LES / LED Size	Φ 9.8 mm		
FWHM (D50)	40°		
Field Angle (D10)	71°		
H (distance)	2.4 mm		
Dimension	Φ =33.9 mm, Thickness= 8.2 mm		
Luminous Flux	1759 lm		Measured @ 12.6 W
Material	PC / UL94V2		

## cd/klm

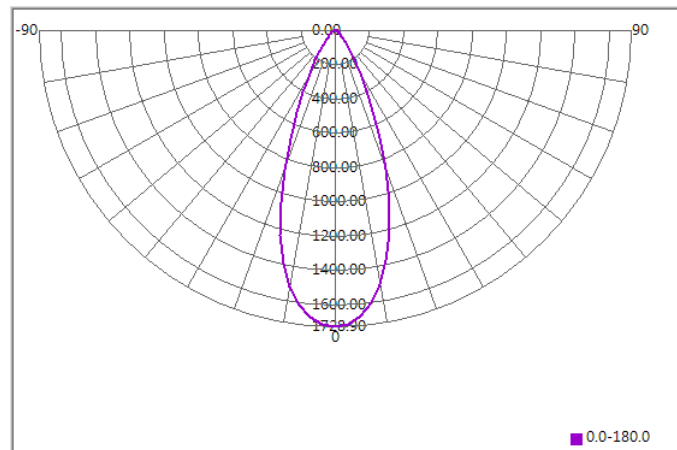

## Illuminance At Distances

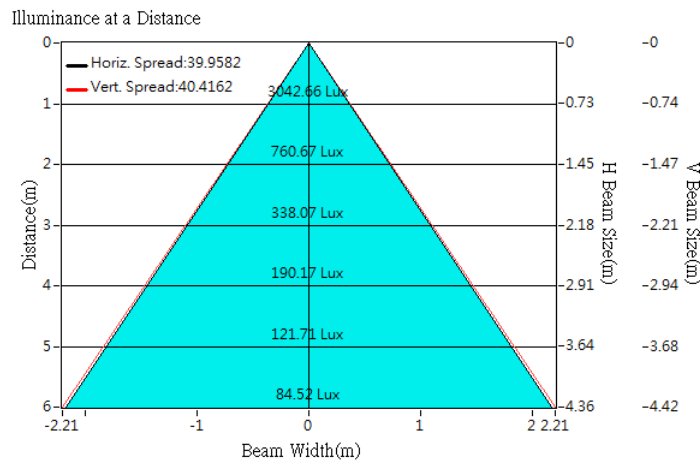



## Optical Characteristics

Model Number	CKO-CU15-034009-9907	<p>"H" definition</p>
LED	<b>CLU 026</b>	
LES / LED Size	Φ 9.8 mm	
FWHM (D50)	42°	
Field Angle (D10)	75°	
H (distance)	2.4 mm	
Dimension	Φ =33.9 mm, Thickness= 8.2 mm	
Luminous Flux	1707 lm	
Material	PC / UL94V2	

## cd/klm

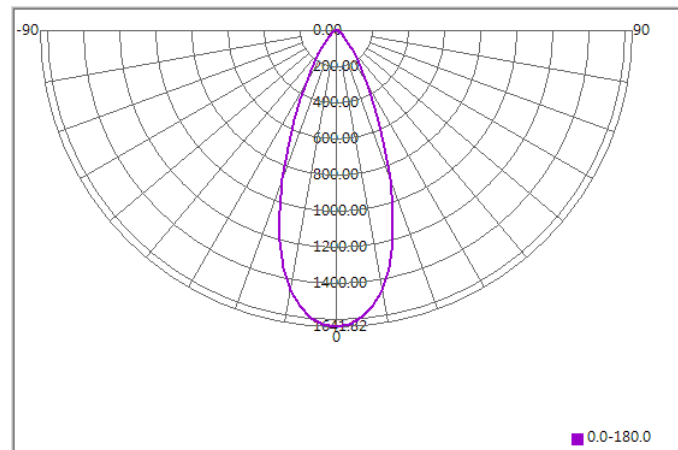

## Illuminance At Distances

