



Product Model Number

CKO-CU15-034009-9907

✓ Model Number Definitions

CKO-XXXX-XXXXXX-XXXX



- A. Chun Kuang Optics Corp. Product
- B. Product Type: product abbreviation
Ex:
CH→CoB High Intensity
CC→CoB Compact
CS→Soft Shading for CoB LED
HC→Holder for CoB LED

- C. Identity Code
- D. Lens / Fixture Size
Ex: 075026=Φ75mm / Thickness=26mm (round up)
- C. Serial Numbers

The lens datasheet is applicable for **Cree LED**, that manufactured by Chun Kuang Optics Corp.

✓ Dimensions (mm) : Φ33.9 x 8.2

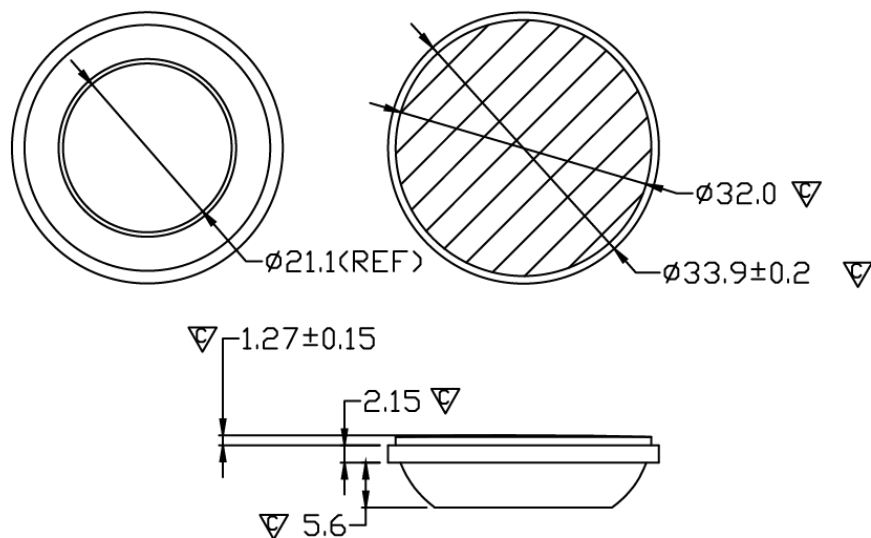

▽:Critical Dimension



Optical Characteristics

Model Number	CKO-CU15-034009-9907		<p>"H" definition</p>
LED	MHD-E		
LES / LED Size	7.0 x 7.0 mm		
FWHM (D50)	35°		
Field Angle (D10)	61°		
H (distance)	2.4 mm		
Dimension	Φ =33.9 mm, Thickness= 8.2 mm		
Luminous Flux	903 lm	Measured @ 7.5 W	
Material	PC / UL94V2		

cd/klm

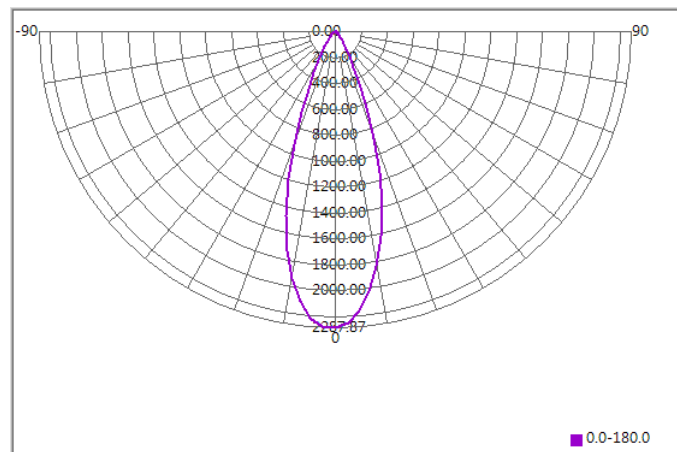

Illuminance At Distances

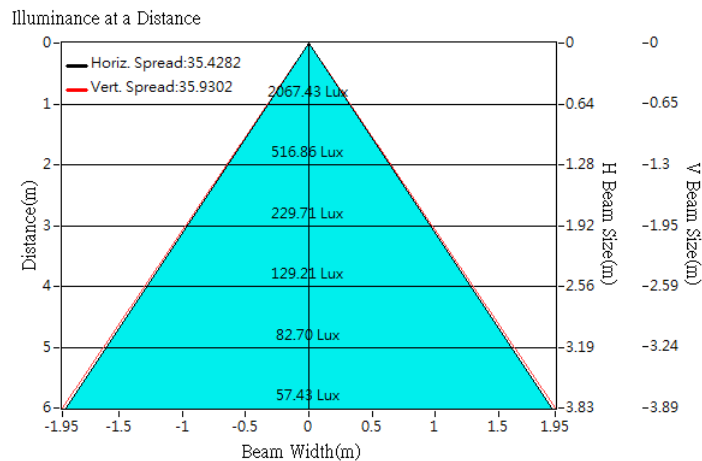



Optical Characteristics

Model Number	CKO-CU15-034009-9907		<p>"H" definition</p> <p>LES CoB</p>
LED	CMA1303		
LES / LED Size	Φ 4.5 mm		
FWHM (D50)	33°		
Field Angle (D10)	58°		
H (distance)	2.4 mm		
Dimension	Φ =33.9 mm, Thickness= 8.2 mm		
Luminous Flux	802 lm	Measured @ 6.7 W	
Material	PC / UL94V2		

cd/klm

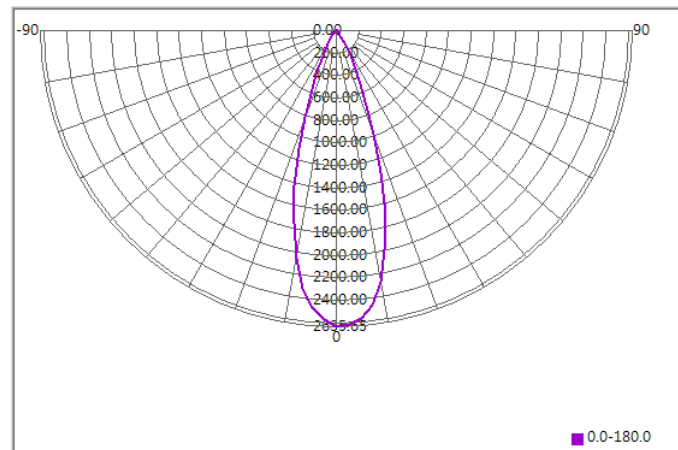

Illuminance At Distances

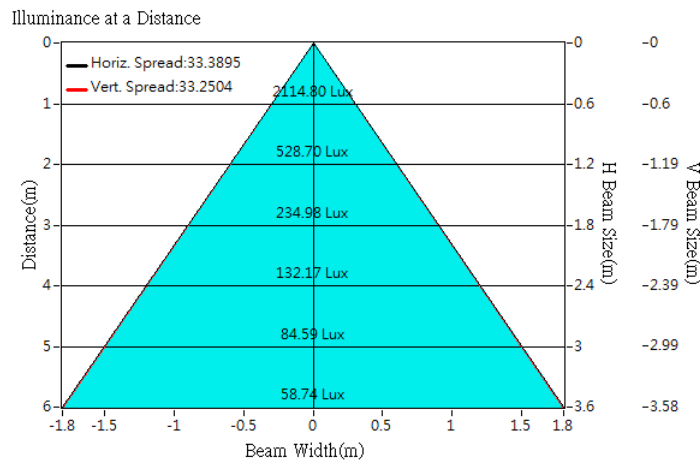



Optical Characteristics

Model Number	CKO-CU15-034009-9907		<p>"H" definition</p> <p>LES CoB</p>
LED	CXA1304		
LES / LED Size	Φ 6 mm		
FWHM (D50)	36°		
Field Angle (D10)	63°		
H (distance)	2.4 mm		
Dimension	Φ =33.9 mm, Thickness= 8.2 mm		
Luminous Flux	400 lm	Measured @ 3.7 W	
Material	PC / UL94V2		

cd/klm

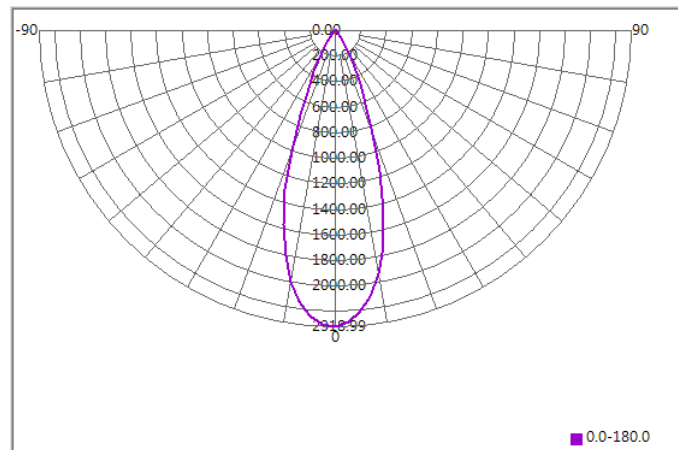

Illuminance At Distances

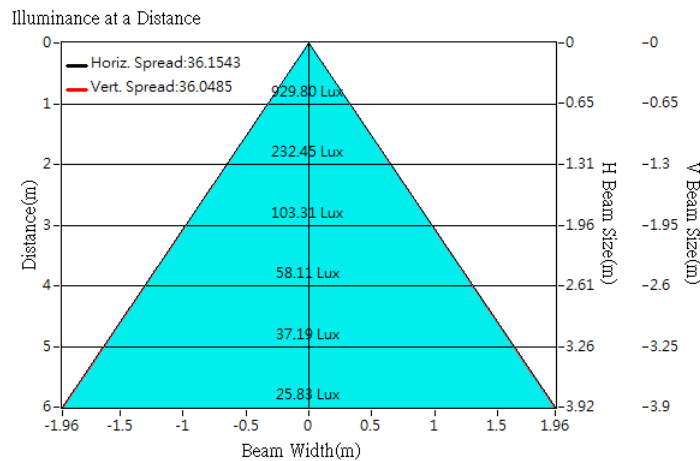



Optical Characteristics

Model Number	CKO-CU15-034009-9907		<p>"H" definition</p>
LED	CXB1304		
LES / LED Size	Φ 6 mm		
FWHM (D50)	35°		
Field Angle (D10)	60°		
H (distance)	2.4 mm		
Dimension	Φ =33.9 mm, Thickness= 8.2 mm		
Luminous Flux	460 lm	Measured @ 3.5 W	
Material	PC / UL94V2		

cd/klm

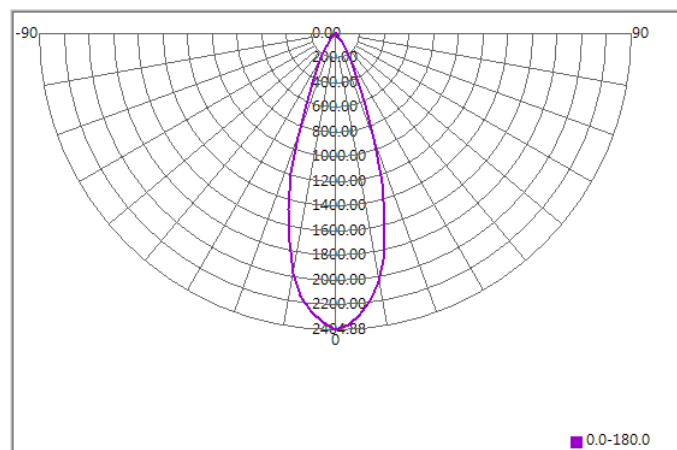

Illuminance At Distances

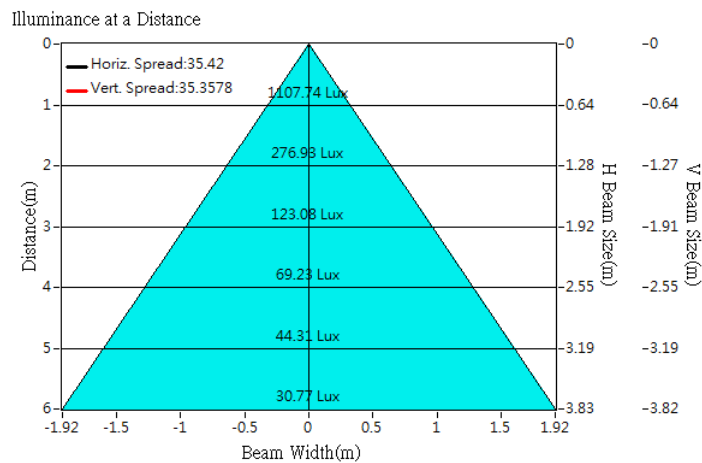



Optical Characteristics

Model Number	CKO-CU15-034009-9907	<p>"H" definition</p>	
LED	CMA1306		
LES / LED Size	Φ 6 mm		
FWHM (D50)	35°		
Field Angle (D10)	60°		
H (distance)	2.4 mm		
Dimension	Φ =33.9 mm, Thickness= 8.2 mm		
Luminous Flux	998 lm		Measured @ 7.3 W
Material	PC / UL94V2		

cd/klm

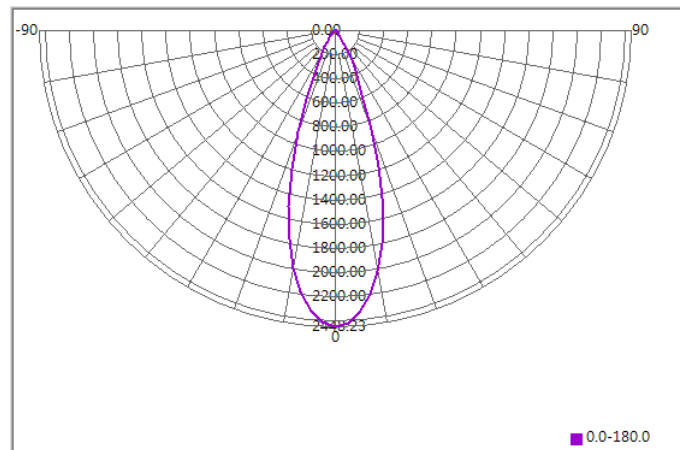

Illuminance At Distances

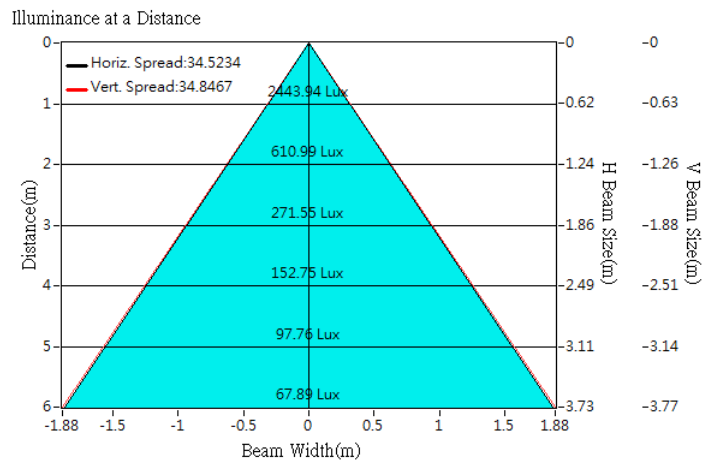



Optical Characteristics

Model Number	CKO-CU15-034009-9907		<p>"H" definition</p>
LED	CXB1310		
LES / LED Size	Φ 6 mm		
FWHM (D50)	35°		
Field Angle (D10)	60°		
H (distance)	2.4 mm		
Dimension	Φ =33.9 mm, Thickness= 8.2 mm		
Luminous Flux	1548 lm	Measured @ 12.1 W	
Material	PC / UL94V2		

cd/klm

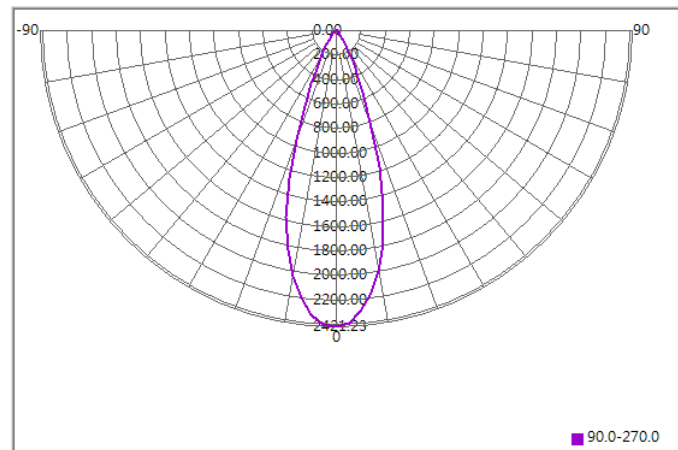

Illuminance At Distances

