



Product Model Number

CKO-CU15-034009-9909

✓ Model Number Definitions

CKO-XXXX-XXXXXX-XXXX



- A. Chun Kuang Optics Corp. Product
- B. Product Type: product abbreviation
Ex:
CH→CoB High Intensity
CC→CoB Compact
CS→Soft Shading for CoB LED
HC→Holder for CoB LED

- C. Identity Code
- D. Lens / Fixture Size
Ex: 075026=Φ75mm / Thickness=26mm (round up)
- C. Serial Numbers

The lens datasheet is applicable for **Cree LED**, that manufactured by Chun Kuang Optics Corp.

✓ Dimensions (mm) : Φ33.9 x 8.2

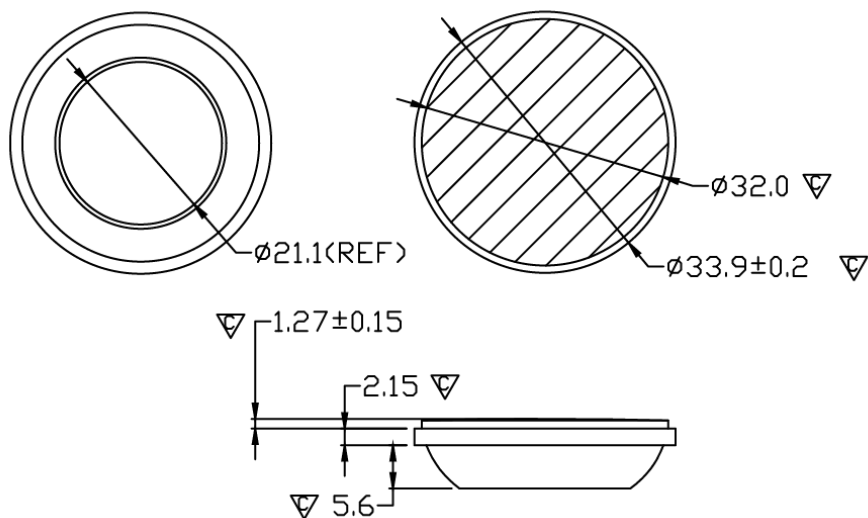

∇:Critical Dimension



Optical Characteristics

Model Number	CKO-CU15-034009-9909		<p>"H" definition</p>
LED	MHD-E		
LES / LED Size	7.0 x 7.0 mm		
FWHM (D50)	40°		
Field Angle (D10)	67°		
H (distance)	2.4 mm		
Dimension	Φ =33.9 mm, Thickness= 8.2 mm		
Luminous Flux	898 lm	Measured @ 7.5 W	
Material	PC / UL94V2		

cd/klm

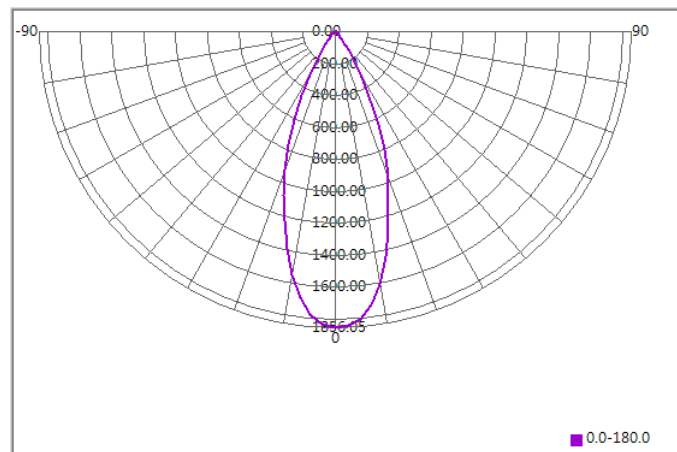

Illuminance At Distances

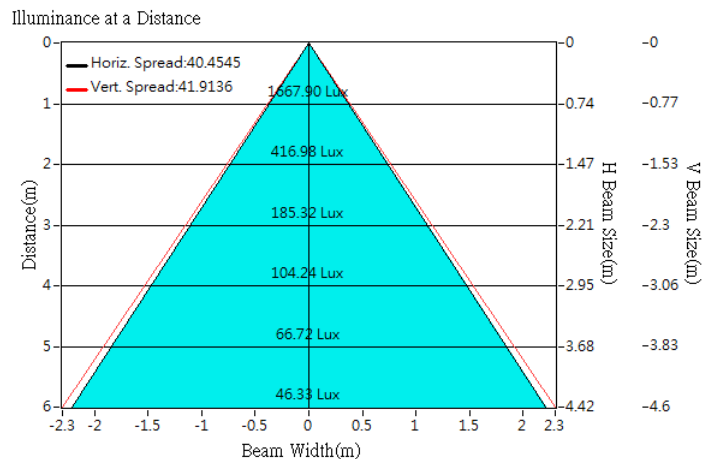



Optical Characteristics

Model Number	CKO-CU15-034009-9909		<p>"H" definition</p> <p>LES CoB</p>
LED	CXB1304		
LES / LED Size	Φ 6 mm		
FWHM (D50)	42°		
Field Angle (D10)	67°		
H (distance)	2.4 mm		
Dimension	Φ =33.9 mm, Thickness= 8.2 mm		
Luminous Flux	461 lm	Measured @ 3.5 W	
Material	PC / UL94V2		

cd/klm

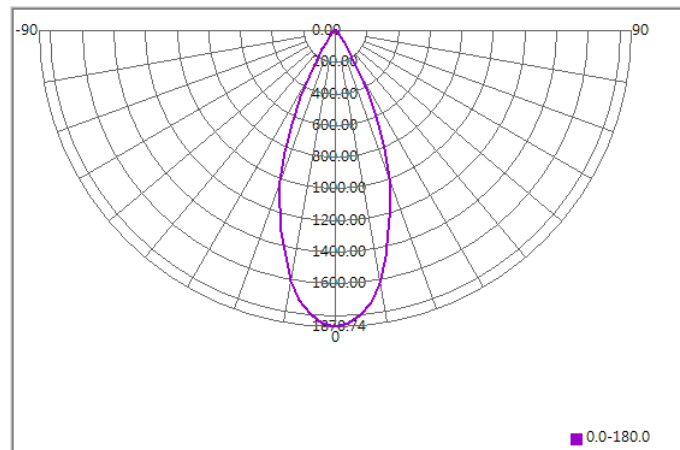

Illuminance At Distances

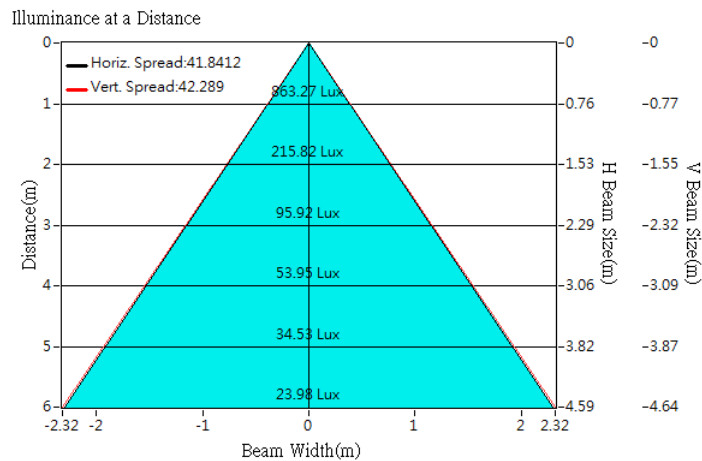



Optical Characteristics

Model Number	CKO-CU15-034009-9909	<p>"H" definition</p>
LED	CMA1306	
LES / LED Size	Φ 6 mm	
FWHM (D50)	39°	
Field Angle (D10)	65°	
H (distance)	2.4 mm	
Dimension	Φ =33.9 mm, Thickness= 8.2 mm	
Luminous Flux	1008 lm	
Material	PC / UL94V2	

cd/klm

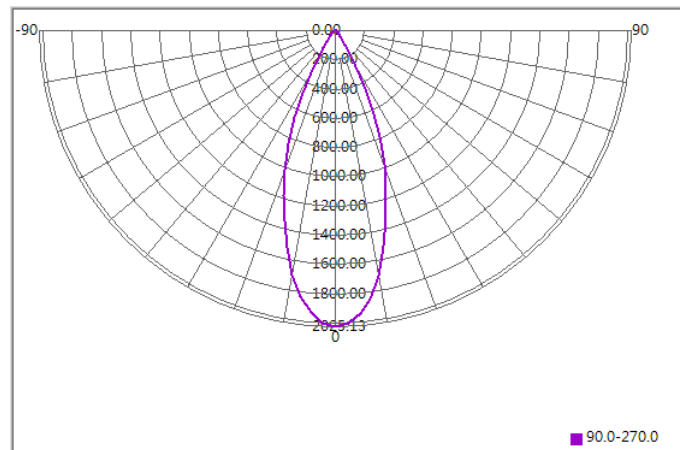

Illuminance At Distances

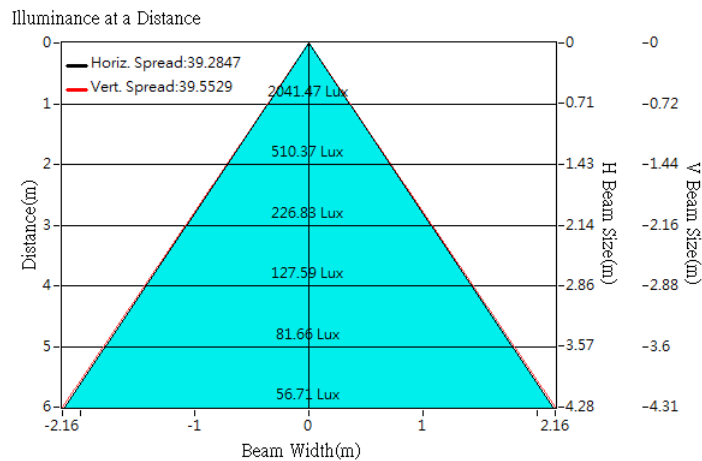



Optical Characteristics

Model Number	CKO-CU15-034009-9909	<p>"H" definition</p>
LED	CXB1310	
LES / LED Size	Φ 6 mm	
FWHM (D50)	40°	
Field Angle (D10)	66°	
H (distance)	2.4 mm	
Dimension	Φ =33.9 mm, Thickness= 8.2 mm	
Luminous Flux	1559 lm	
Material	PC / UL94V2	

cd/klm

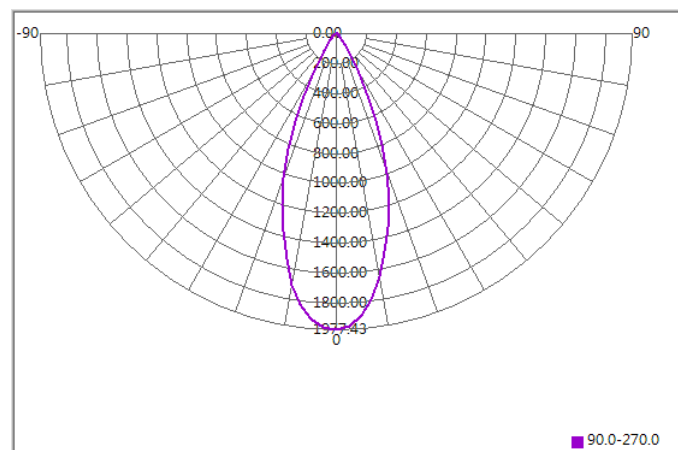

Illuminance At Distances

