



Product Model Number

CKO-CU15-034009-9911

✓ Model Number Definitions

CKO-XXXX-XXXXXX-XXXX



- A. Chun Kuang Optics Corp. Product
- B. Product Type: product abbreviation
Ex:
CH→CoB High Intensity
CC→CoB Compact
CS→Soft Shading for CoB LED
HC→Holder for CoB LED

- C. Identity Code
- D. Lens / Fixture Size
Ex: 075026=Φ75mm / Thickness=26mm (round up)
- C. Serial Numbers

The lens datasheet is applicable for **Philips LED**, that manufactured by Chun Kuang Optics Corp.

✓ Dimensions (mm) : Φ33.9 x 8.2

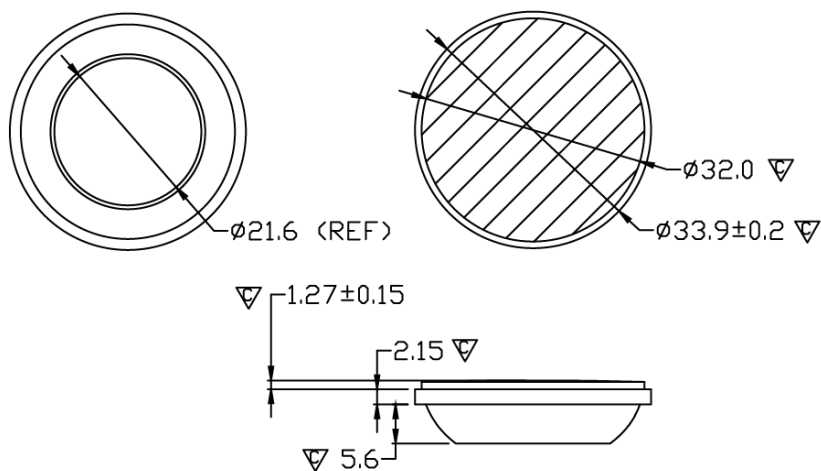

▽:Critical Dimension



Optical Characteristics

Model Number	CKO-CU15-034009-9911		<p>"H" definition</p> <p>LES CoB</p>
LED	Fortimo SLM 1202 L06 G7		
LES / LED Size	Φ 6.5 mm		
FWHM (D50)	61°		
Field Angle (D10)	105°		
H (distance)	2.4 mm		
Dimension	Φ =33.9 mm, Thickness= 8.2 mm		
Luminous Flux	1392 lm	Measured @ 13 W	
Material	PC / UL94V2		

cd/klm

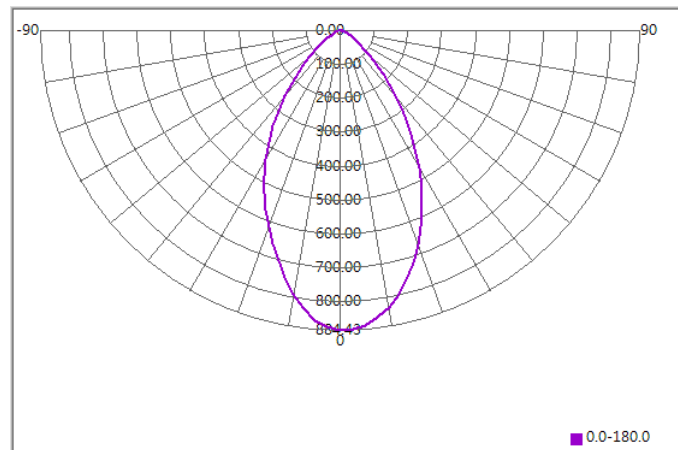

Illuminance At Distances

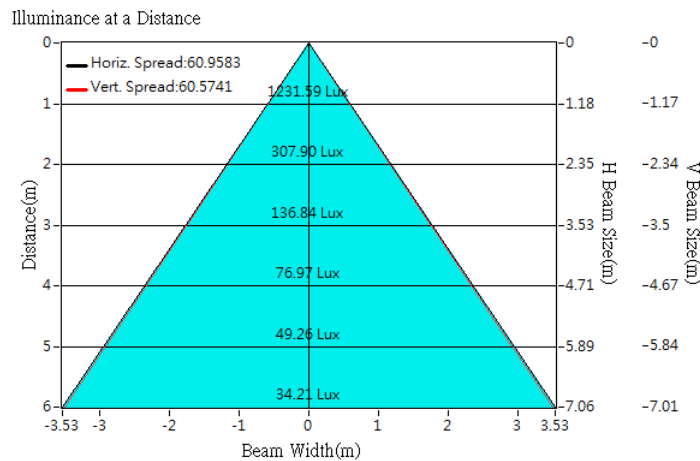

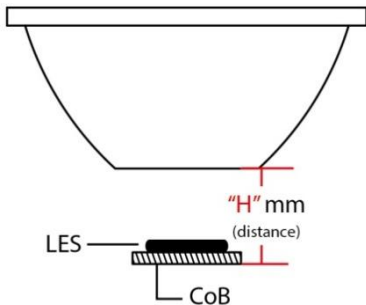

Optical Characteristics

Model Number	CKO-CU15-034009-9911		<p>"H" definition</p> 
LED	Fortimo SLM 1202 L06 G6		
LES / LED Size	Φ 6.5 mm		
FWHM (D50)	64°		
Field Angle (D10)	107°		
H (distance)	2.4 mm		
Dimension	Φ =33.9 mm, Thickness= 8.2 mm		
Luminous Flux	842 lm	Measured @ 7.2 W	
Material	PC / UL94V2		

cd/klm

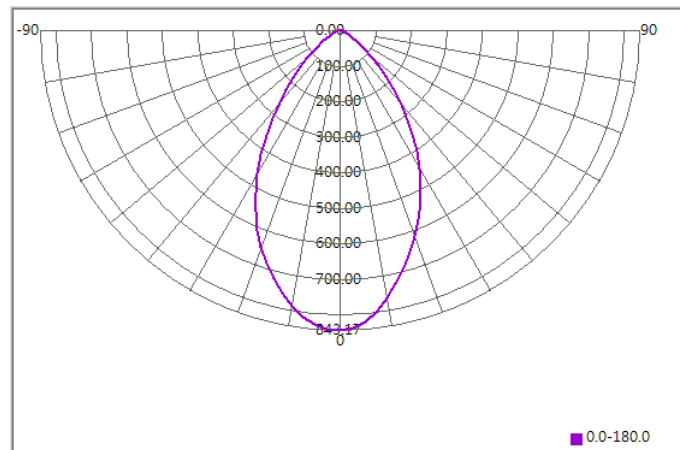

Illuminance At Distances

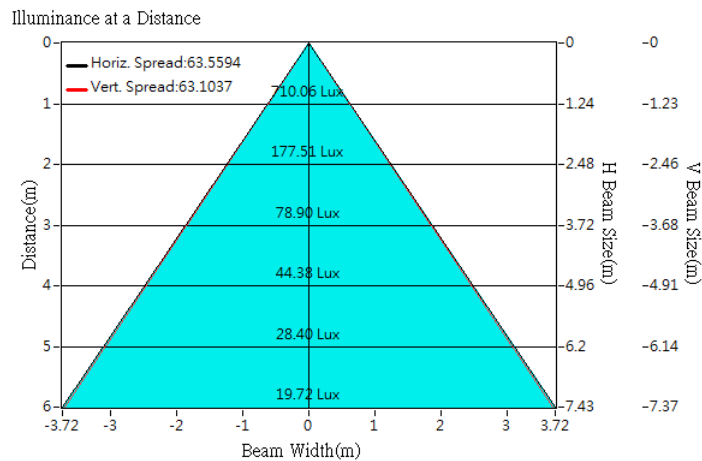



Optical Characteristics

Model Number	CKO-CU15-034009-9911		<p>"H" definition</p>
LED	Fortimo SLM 1203 L09 G6		
LES / LED Size	Φ 9 mm		
FWHM (D50)	64°		
Field Angle (D10)	109°		
H (distance)	2.4 mm		
Dimension	Φ =33.9 mm, Thickness= 8.2 mm		
Luminous Flux	1313 lm	Measured @ 10.4 W	
Material	PC / UL94V2		

cd/klm

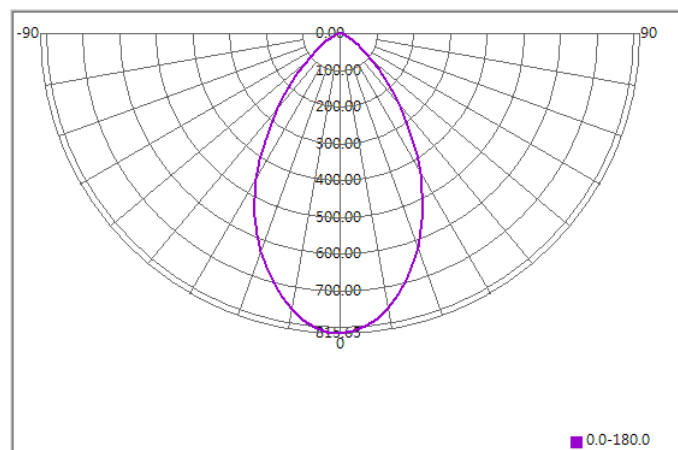

Illuminance At Distances

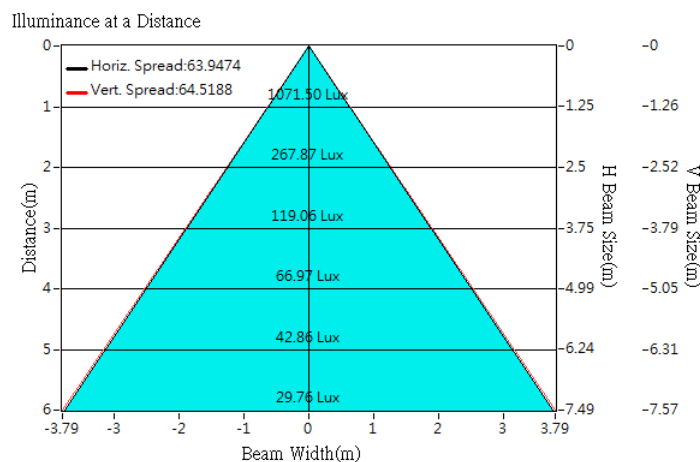



Optical Characteristics

Model Number	CKO-CU15-034009-9911		<p>"H" definition</p>
LED	Fortimo SLM PW 1204 L09 G7		
LES / LED Size	Φ 9 mm		
FWHM (D50)	62°		
Field Angle (D10)	108°		
H (distance)	2.4 mm		
Dimension	Φ =33.9 mm, Thickness= 8.2 mm		
Luminous Flux	2393 lm	Measured @ 26.7 W	
Material	PC / UL94V2		

cd/klm

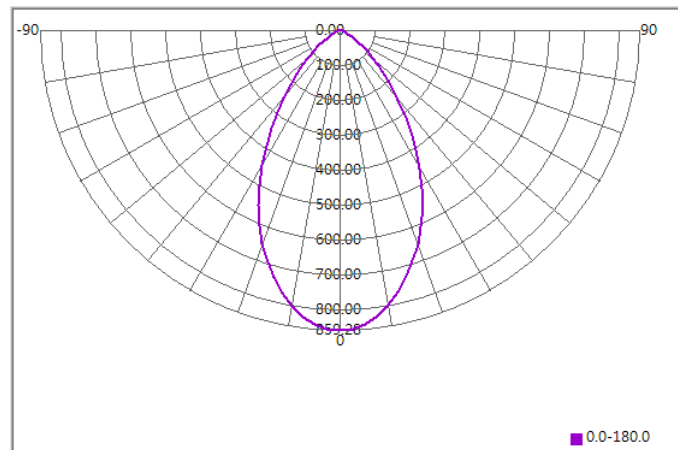

Illuminance At Distances

