



Product Model Number

CKO-CU15-034009-9913

✓ Model Number Definitions

CKO-XXXX-XXXXXX-XXXX



- A. Chun Kuang Optics Corp. Product
- B. Product Type: product abbreviation
Ex:
CH→CoB High Intensity
CC→CoB Compact
CS→Soft Shading for CoB LED
HC→Holder for CoB LED

- C. Identity Code
- D. Lens / Fixture Size
Ex: 075026=Φ75mm / Thickness=26mm (round up)
- C. Serial Numbers

The lens datasheet is applicable for **TRIDONIC LED**, that manufactured by Chun Kuang Optics Corp.

✓ Dimensions (mm) : Φ33.9 x 8.2

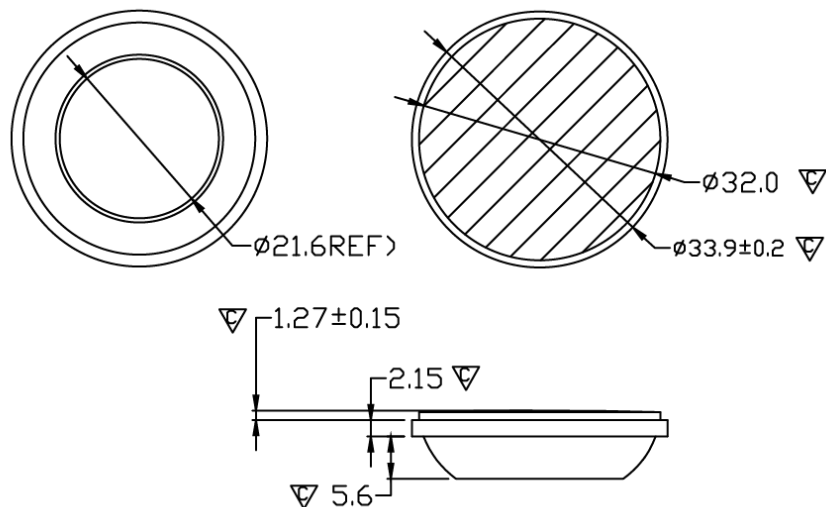

▽:Critical Dimension

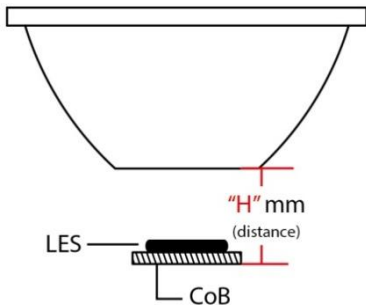

Optical Characteristics

Model Number	CKO-CU15-034009-9913		<p>"H" definition</p> 
LED	SLE G7 09mm 1200lm 940 R ADV		
LES / LED Size	Φ 6 mm		
FWHM (D50)	56°		
Field Angle (D10)	86°		
H (distance)	2.5mm		
Dimension	Φ =35 mm, Thickness=17.4 mm		
Luminous Flux	1540 lm	Measured @ 12.4 W	
Material	PC / UL94V2		

cd/klm

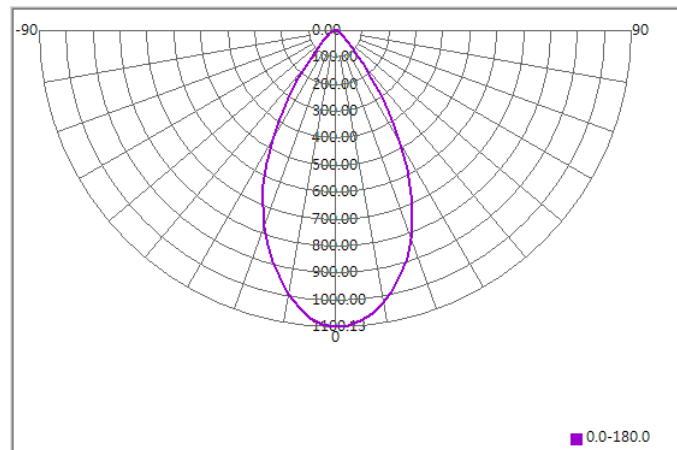

Illuminance At Distances

