



Product Model Number

CKO - M 3 1 2 - 0 3 5 0 1 1 - 2 5 0 1

✓ Model Number Definitions

CKO-XXXX-XXXXXX-XXXX

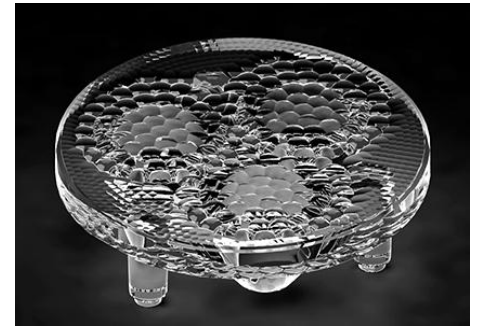

- A. Chun Kuang Optics Corp. Product
- B. Product Type: product abbreviation
Ex:
CH→CoB High Intensity
CC→CoB Compact
CS→Soft Shading for CoB LED
HC→Holder for CoB LED

- C. Identity Code
- D. Lens / Fixture Size
Ex: 075026=Φ75mm / Thickness=26mm (round up)
- C. Serial Numbers

The lens datasheet is applicable for **Lumileds LED**, that manufactured by Chun Kuang Optics Corp.

✓ Dimensions (mm) : Φ35 x 10.9

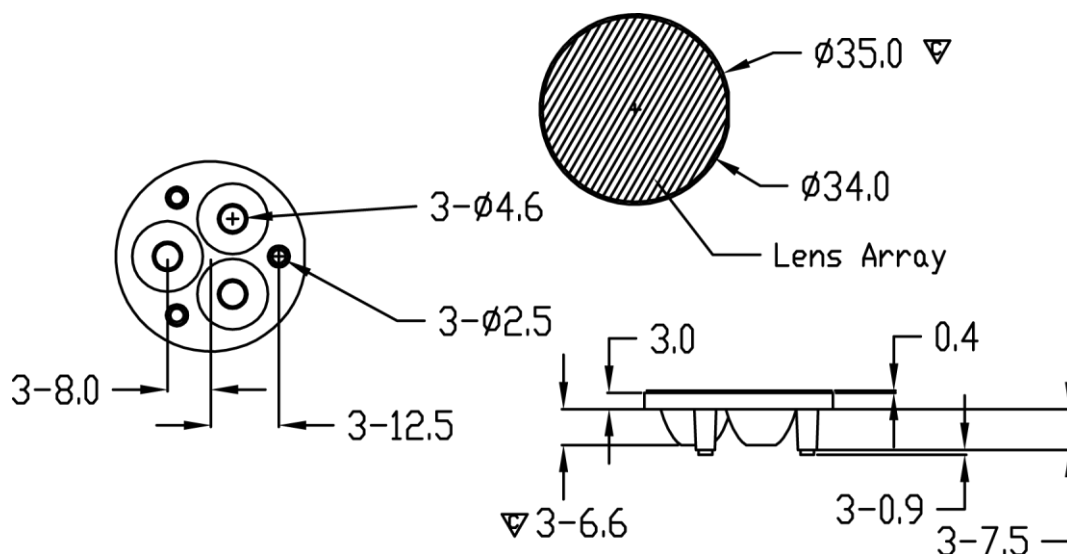

▽:Critical Dimension



Optical Characteristics

Model Number	CKO-M312-035011-2501	
LED	LUXEON 3030 2D	
LES / LED Size	3 x 3 mm	
FWHM (D50)	24°	
Field Angle (D10)	46°	
Dimension	Φ =35 mm, Thickness=10.9 mm	
Luminous Flux	210 lm	Measured @ 2.1 W
Material	PC / UL94V0	

cd/klm

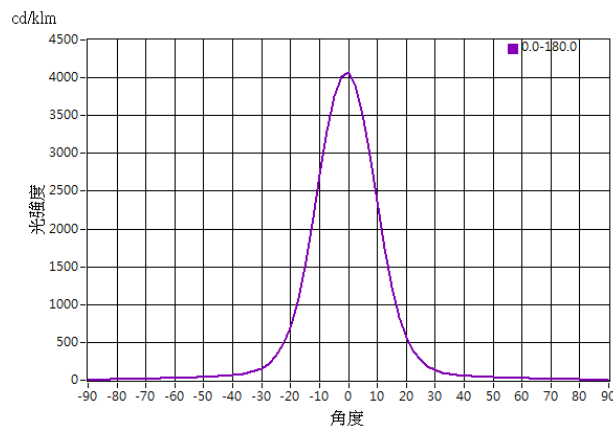

Illuminance At Distances

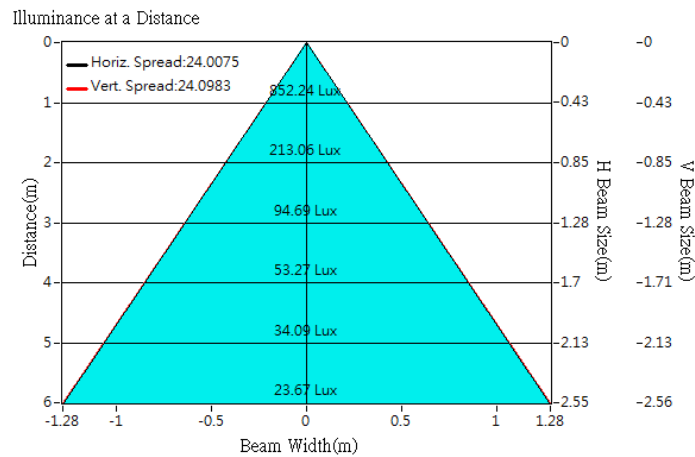



Optical Characteristics

Model Number	CKO-M312-035011-2501	
LED	LUXEON Rebel ES	
LES / LED Size	3 x 4.5 mm	
FWHM (D50)	24°	
Field Angle (D10)	48°	
Dimension	Φ =35 mm, Thickness=10.9 mm	
Luminous Flux	349 lm	Measured @ 3.1 W
Material	PC / UL94V0	

cd/klm

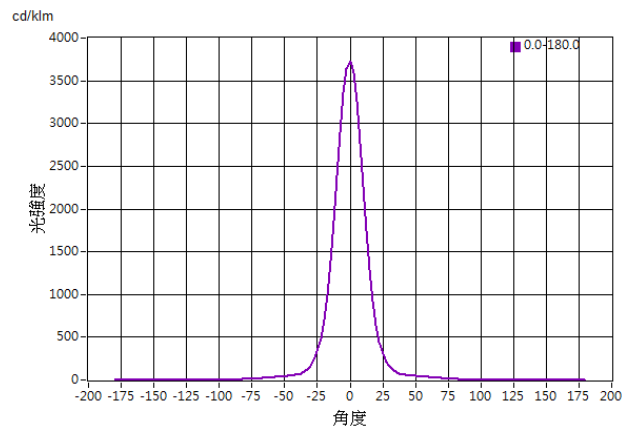

Illuminance At Distances

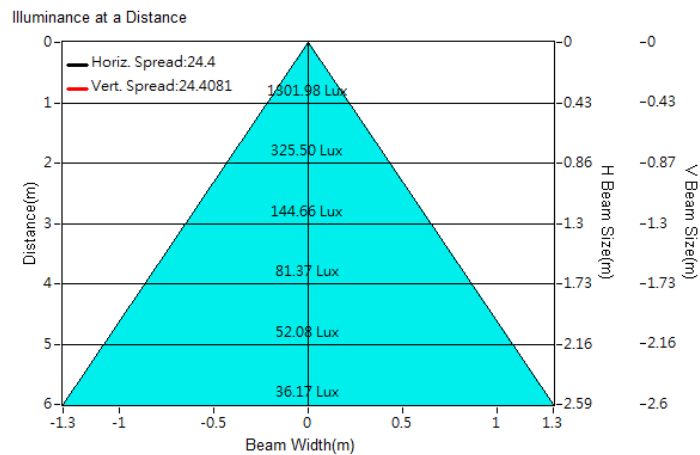



Optical Characteristics

Model Number	CKO-M312-035011-2501	
LED	LUXEON Rebel PLUS	
LES / LED Size	3 x 4.5 mm	
FWHM (D50)	23°	
Field Angle (D10)	43°	
Dimension	Φ =35 mm, Thickness=10.9 mm	
Luminous Flux	264 lm	Measured @ 3 W
Material	PC / UL94V0	

cd/klm

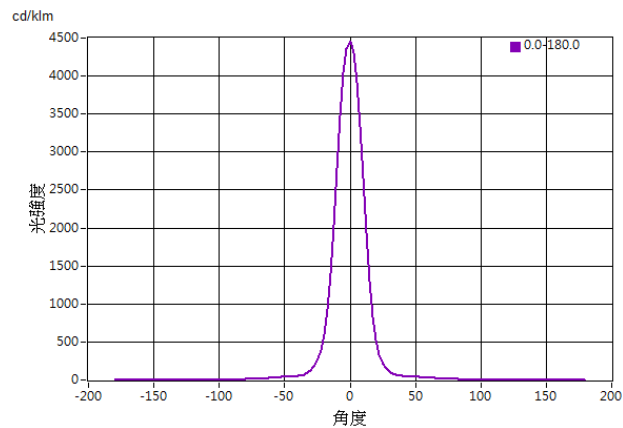

Illuminance At Distances

