



Product Model Number

CKO - M 5 1 2 - 0 3 9 0 1 1 - 6 9 0 1

✓ Model Number Definitions

CKO-XXXX-XXXXXX-XXXX



- A. Chun Kuang Optics Corp. Product
- B. Product Type: product abbreviation
Ex:
CH→CoB High Intensity
CC→CoB Compact
CS→Soft Shading for CoB LED
HC→Holder for CoB LED

- C. Identity Code
- D. Lens / Fixture Size
Ex: 075026=Φ75mm / Thickness=26mm (round up)
- C. Serial Numbers

The lens datasheet is applicable for **CREE LED**, that manufactured by Chun Kuang Optics Corp.

✓ Dimensions (mm) : Φ39 x 10.9

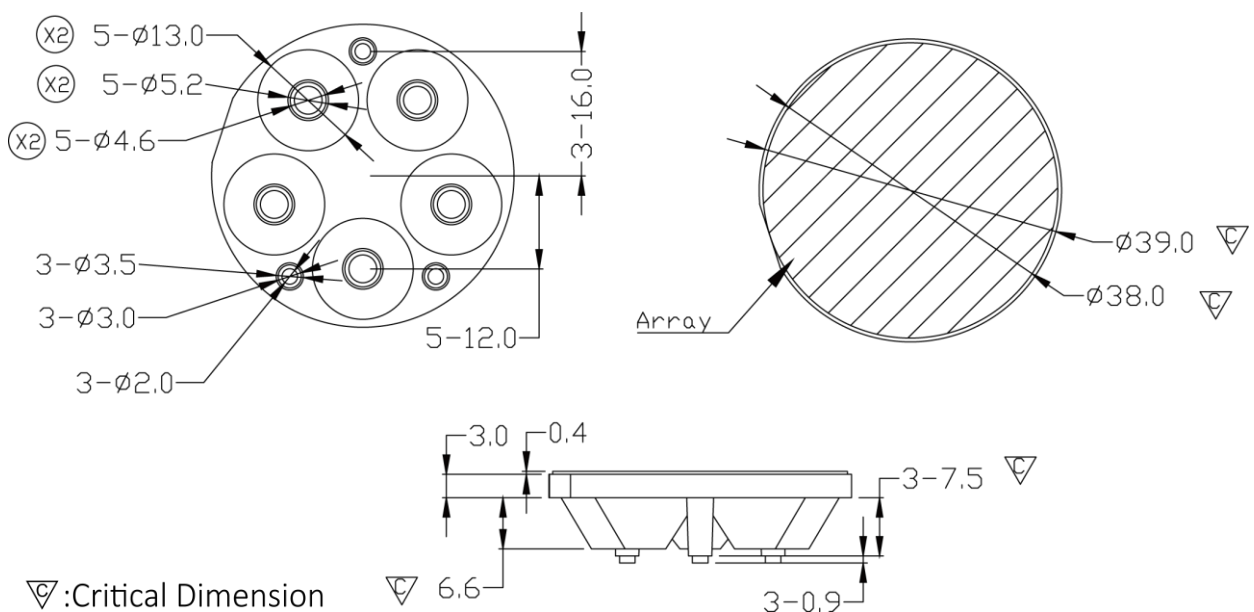



Optical Characteristics

Model Number	CKO-M512-039011-6901	
LED	XB-D	
LES / LED Size	Φ 2.5 x 2.5 mm	
FWHM (D50)	16°	
Field Angle (D10)	33°	
Dimension	Φ =39 mm, Thickness=10.9 mm	
Luminous Flux	494 lm	Measured @ 5.2 W
Material	PC / UL94V0	

cd/klm

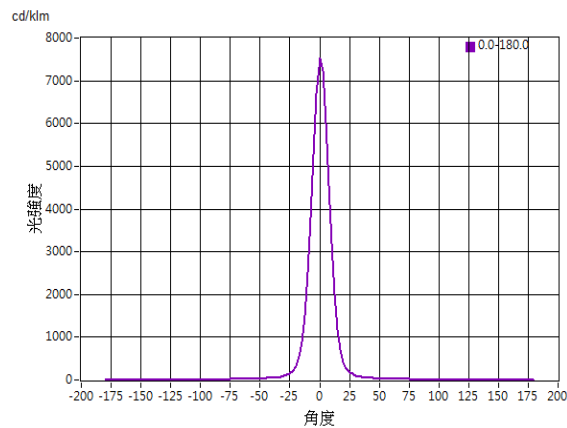

Illuminance At Distances

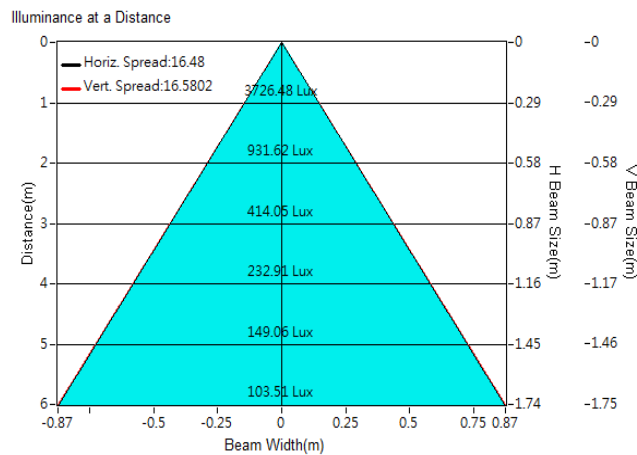



Optical Characteristics

Model Number	CKO-M512-039011-6901	
LED	XB-H	
LES / LED Size	Φ 2.5 x 2.5 mm	
FWHM (D50)	18°	
Field Angle (D10)	37°	
Dimension	Φ =39 mm, Thickness=10.9 mm	
Luminous Flux	555 lm	Measured @ 4.9 W
Material	PC / UL94V0	

cd/klm

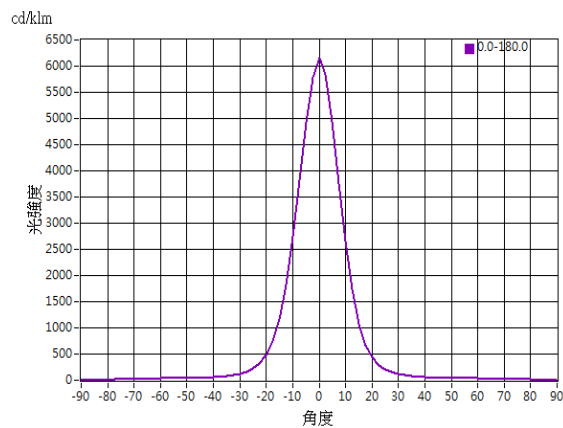

Illuminance At Distances

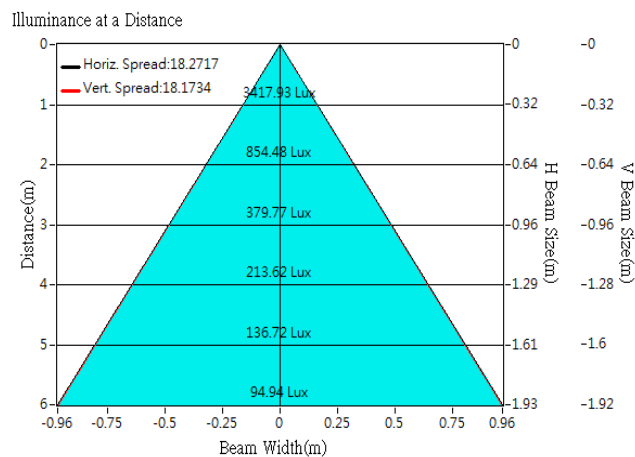



Optical Characteristics

Model Number	CKO-M512-039011-6901	
LED	XP-E	
LES / LED Size	Φ 3.5 x 3.5 mm	
FWHM (D50)	18°	
Field Angle (D10)	32°	
Dimension	Φ =39 mm, Thickness=10.9 mm	
Luminous Flux	305 lm	Measured @ 5.3 W
Material	PC / UL94V0	

cd/klm

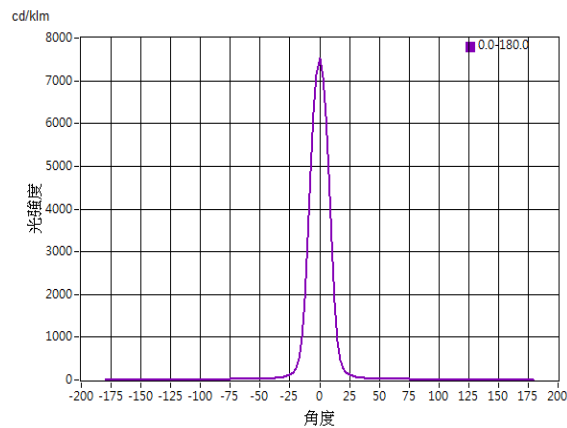

Illuminance At Distances

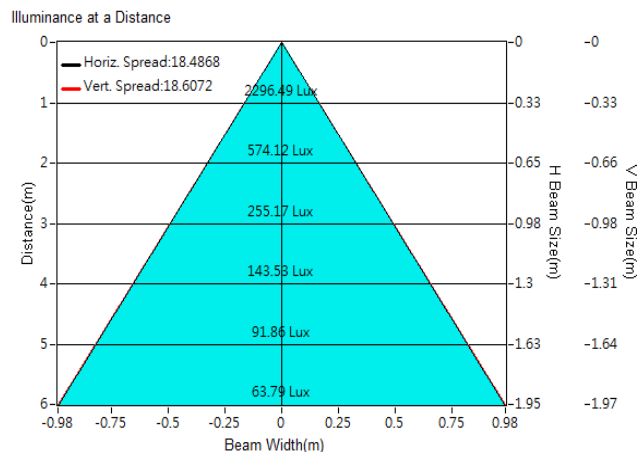



Optical Characteristics

Model Number	CKO-M512-039011-6901	
LED	XP-G	
LES / LED Size	Φ 3.5 x 3.5 mm	
FWHM (D50)	19°	
Field Angle (D10)	37°	
Dimension	Φ =39 mm, Thickness=10.9 mm	
Luminous Flux	448 lm	Measured @ 5 W
Material	PC / UL94V0	

cd/klm

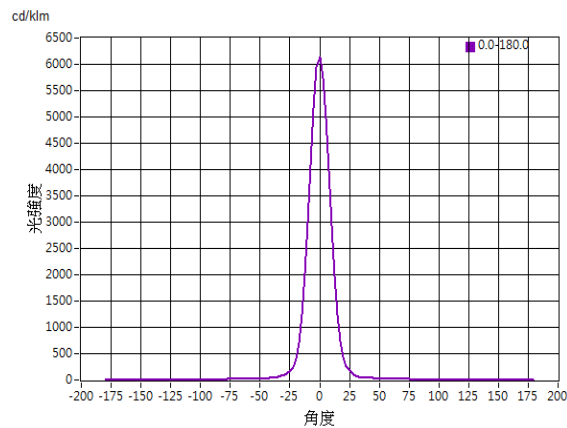

Illuminance At Distances

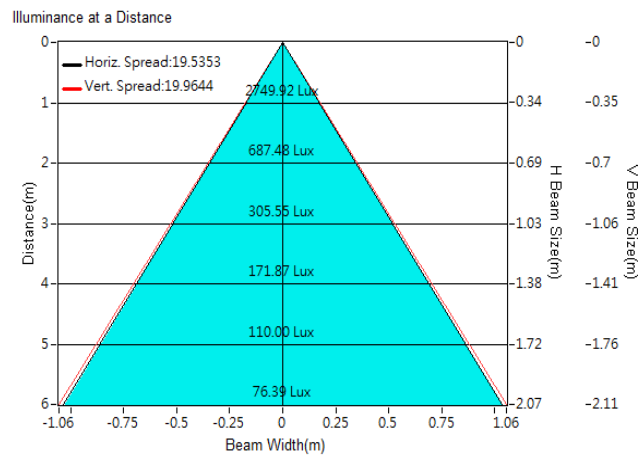



Optical Characteristics

Model Number	CKO-M512-039011-6901	
LED	XP-G2	
LES / LED Size	Φ 3.5 x 3.5 mm	
FWHM (D50)	19°	
Field Angle (D10)	36°	
Dimension	Φ =39 mm, Thickness=10.9 mm	
Luminous Flux	601 lm	Measured @ 5 W
Material	PC / UL94V0	

cd/klm

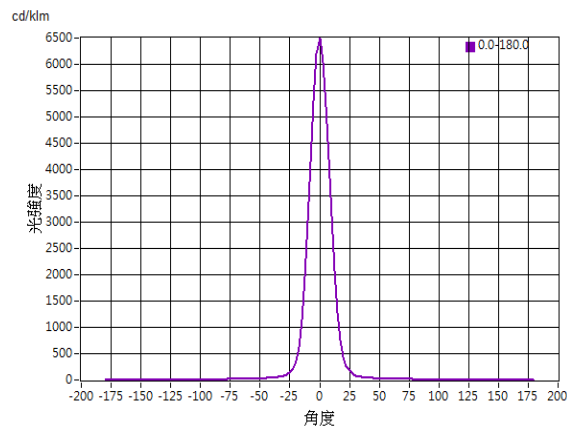

Illuminance At Distances

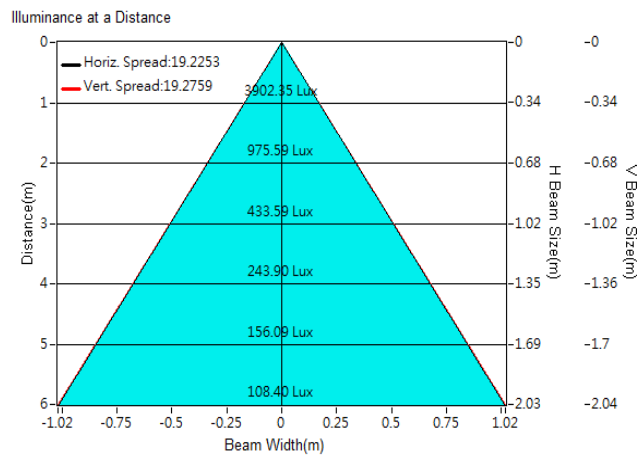



Optical Characteristics

Model Number	CKO-M512-039011-6901	
LED	XP-G3	
LES / LED Size	Φ 3.5 x 3.5 mm	
FWHM (D50)	21°	
Field Angle (D10)	42°	
Dimension	Φ =39 mm, Thickness=10.9 mm	
Luminous Flux	806 lm	Measured @ 4.9 W
Material	PC / UL94V0	

cd/klm

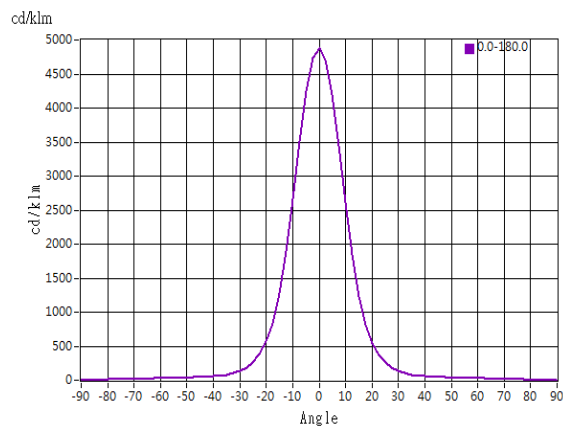

Illuminance At Distances

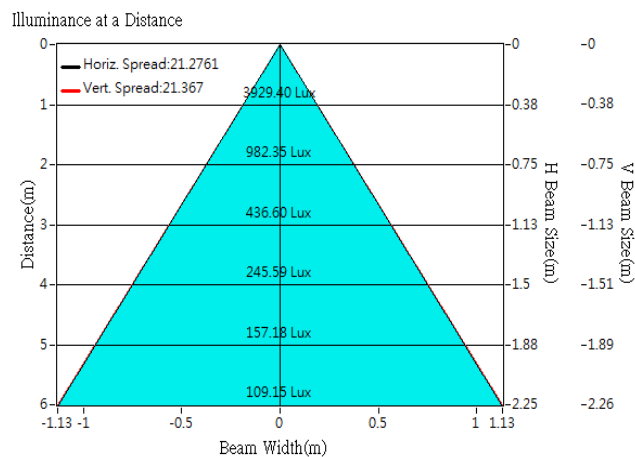



Optical Characteristics

Model Number	CKO-M512-039011-6901	
LED	XP-L	
LES / LED Size	Φ 3.5 x 3.5 mm	
FWHM (D50)	25°	
Field Angle (D10)	47°	
Dimension	Φ =39 mm, Thickness=10.9 mm	
Luminous Flux	2340 lm	Measured @ 3.71 W
Material	PC / UL94V0	

cd/klm

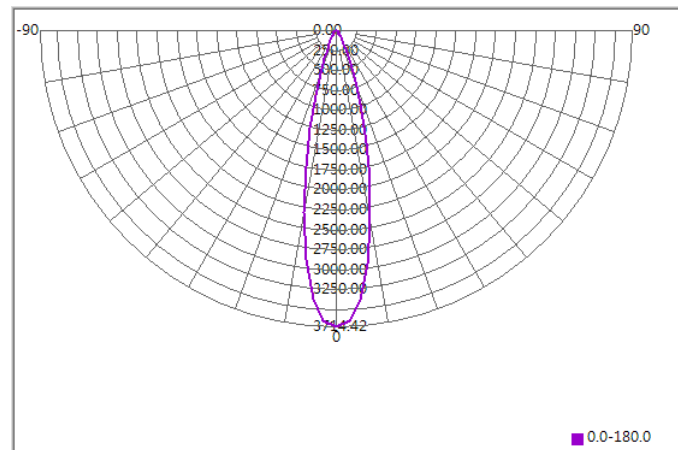

Illuminance At Distances

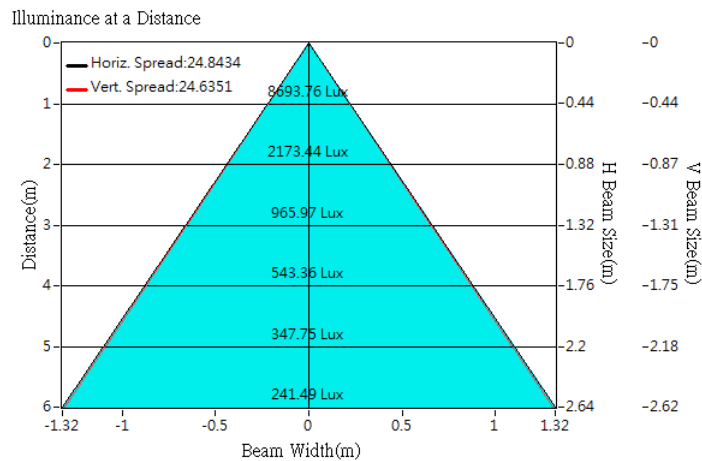



Optical Characteristics

Model Number	CKO-M512-039011-6901	
LED	XP-L HI	
LES / LED Size	Φ 3.5 x 3.5 mm	
FWHM (D50)	19°	
Field Angle (D10)	37°	
Dimension	Φ =39 mm, Thickness=10.9 mm	
Luminous Flux	2036 lm	Measured @ 16.0 W
Material	PC / UL94V0	

cd/klm

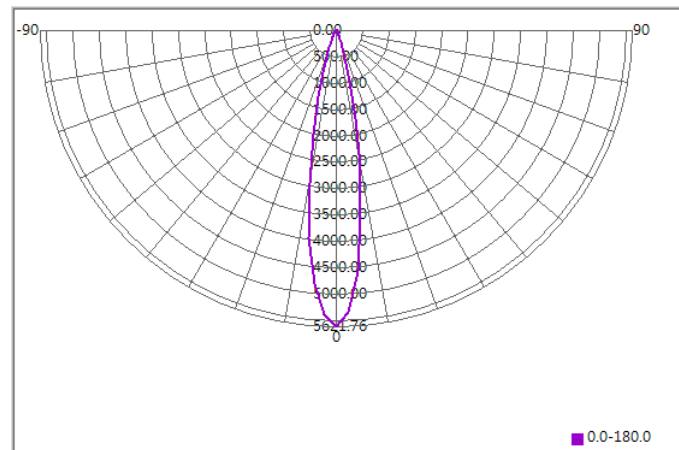

Illuminance At Distances

