



Product Model Number

CKO - M 5 1 2 - 0 3 9 0 1 1 - 7 2 0 1

✓ Model Number Definitions

CKO-XXXX-XXXXXX-XXXX



- A. Chun Kuang Optics Corp. Product
- B. Product Type: product abbreviation
Ex:
CH→CoB High Intensity
CC→CoB Compact
CS→Soft Shading for CoB LED
HC→Holder for CoB LED

- C. Identity Code
- D. Lens / Fixture Size
Ex: 075026=Φ75mm / Thickness=26mm (round up)
- E. Serial Numbers

The lens datasheet is applicable for **Osram LED**, that manufactured by Chun Kuang Optics Corp.

✓ Dimensions (mm) : Φ39 x 10.9

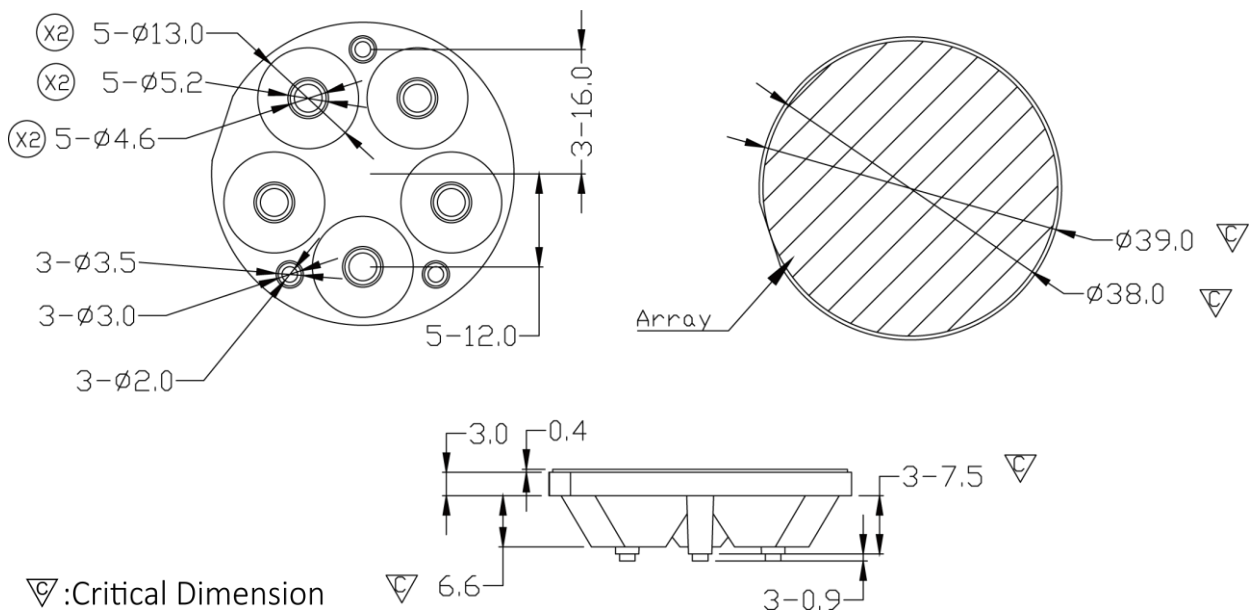



Optical Characteristics

Model Number	CKO-M512-039011-7201	
LED	Duris S5	
LES / LED Size	Φ 3 x 3 mm	
FWHM (D50)	29°	
Field Angle (D10)	64°	
Dimension	Φ =45 mm, Thickness=10.9 mm	
Luminous Flux	428 lm	Measured @ 4.5 W
Material	PC / UL94V0	

cd/klm

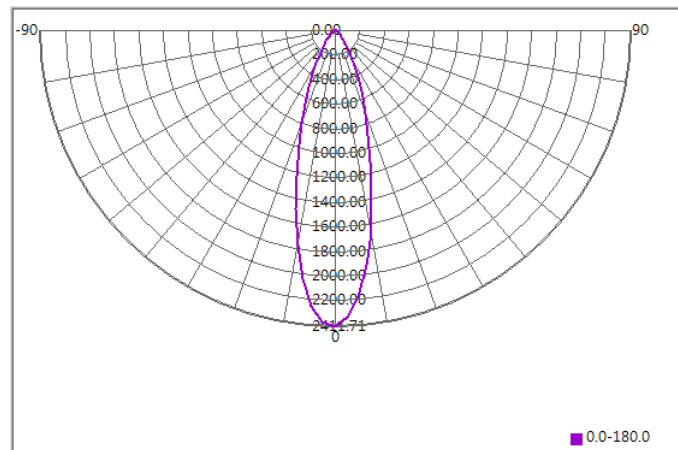

Illuminance At Distances

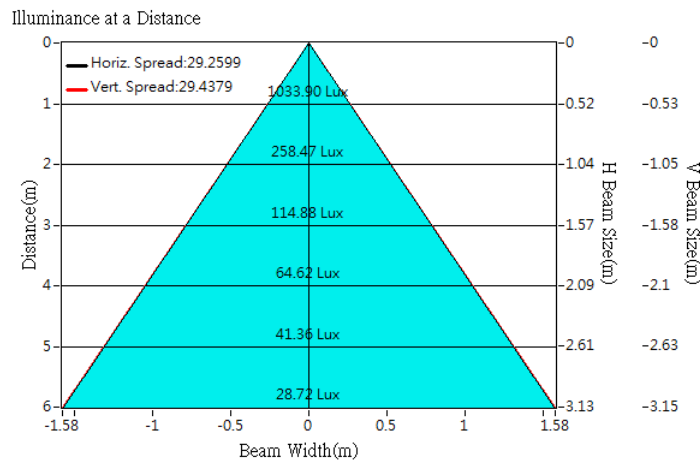



Optical Characteristics

Model Number	CKO-M512-039011-7201	
LED	Oslon SSL 80	
LES / LED Size	Φ 3 x 3 mm	
FWHM (D50)	31°	
Field Angle (D10)	67°	
Dimension	Φ =45 mm, Thickness=10.9 mm	
Luminous Flux	446 lm	Measured @ 5.1 W
Material	PC / UL94V0	

cd/klm

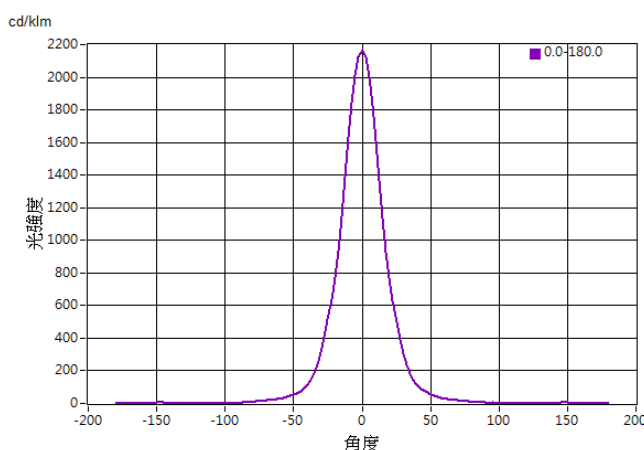

Illuminance At Distances

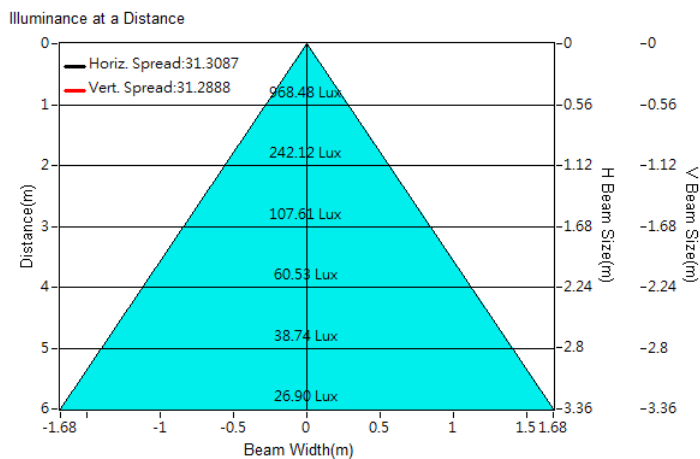



Optical Characteristics

Model Number	CKO-M512-039011-7201	
LED	Oslon SSL 150	
LES / LED Size	Φ 3 x 3 mm	
FWHM (D50)	32°	
Field Angle (D10)	66°	
Dimension	Φ =45 mm, Thickness=10.9 mm	
Luminous Flux	447 lm	Measured @ 5.2 W
Material	PC / UL94V0	

cd/klm

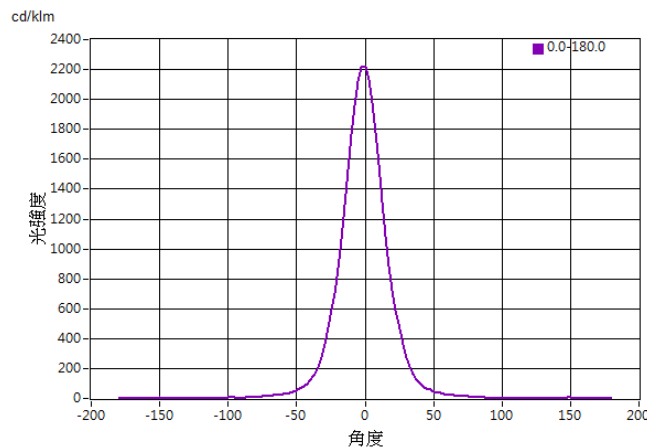

Illuminance At Distances

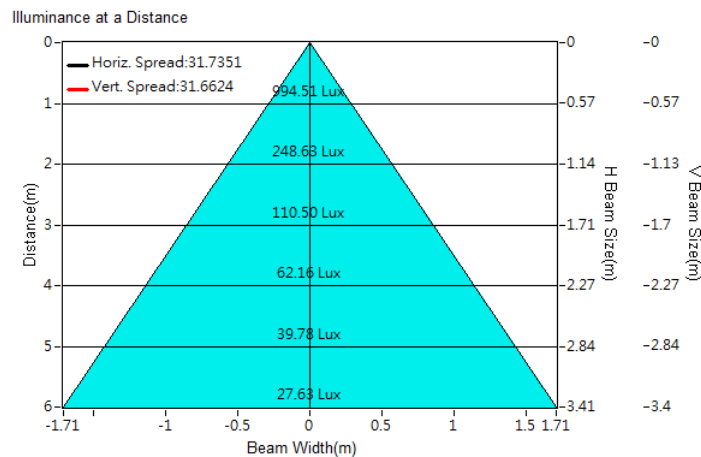



Optical Characteristics

Model Number	CKO-M512-039011-7201	
LED	Oslon Square	
LES / LED Size	Φ 3 x 3 mm	
FWHM (D50)	33°	
Field Angle (D10)	68°	
Dimension	Φ =45 mm, Thickness=10.9 mm	
Luminous Flux	441 lm	Measured @ 4.5 W
Material	PC / UL94V0	

cd/klm

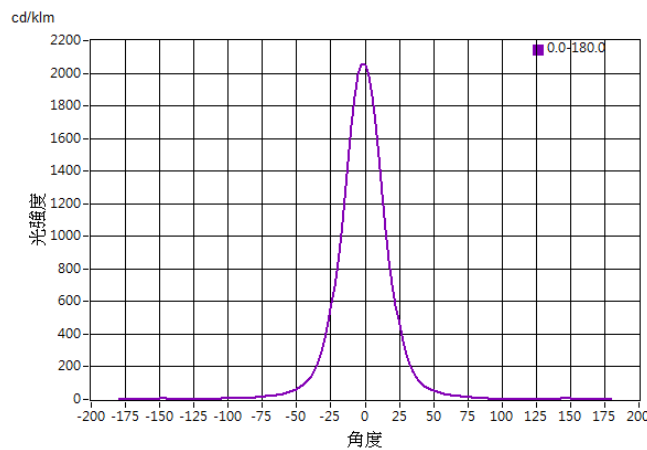

Illuminance At Distances

