



## Product Model Number

CKO - M 7 1 2 - 0 4 5 0 1 1 - 4 6 0 1

### ✓ Model Number Definitions

**CKO-XXXX-XXXXXX-XXXX**



- A. Chun Kuang Optics Corp. Product
- B. Product Type: product abbreviation  
Ex:  
CH→CoB High Intensity  
CC→CoB Compact  
CS→Soft Shading for CoB LED  
HC→Holder for CoB LED

- C. Identity Code
- D. Lens / Fixture Size  
Ex: 075026=Φ75mm / Thickness=26mm (round up)
- C. Serial Numbers

The lens datasheet is applicable for **Osram LED**, that manufactured by Chun Kuang Optics Corp.

### ✓ Dimensions (mm) : Φ45 x 10.9

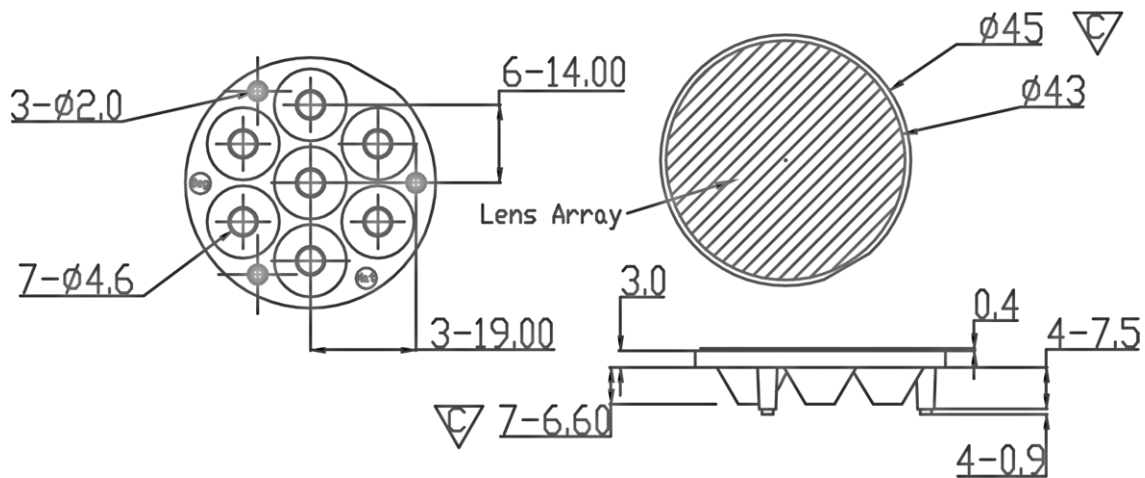

▽:Critical Dimension





## Optical Characteristics

|                   |                             |                  |
|-------------------|-----------------------------|------------------|
| Model Number      | CKO-M712-045011-4601        |                  |
| LED               | <b>Duris S5</b>             |                  |
| LES / LED Size    | Φ 3 x 3 mm                  |                  |
| FWHM (D50)        | 29°                         |                  |
| Field Angle (D10) | 64°                         |                  |
| Dimension         | Φ =45 mm, Thickness=10.9 mm |                  |
| Luminous Flux     | 610 lm                      | Measured @ 6.5 W |
| Material          | PC / UL94V0                 |                  |

## cd/klm

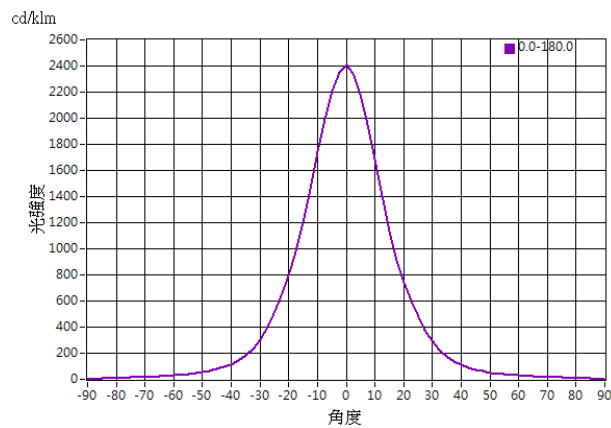

## Illuminance At Distances

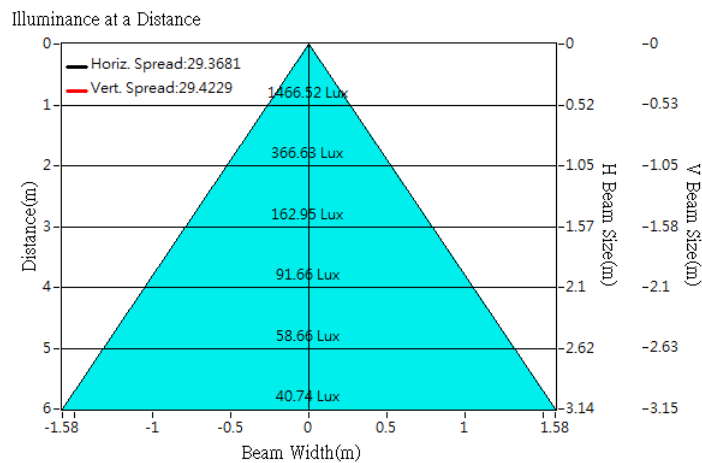



## Optical Characteristics

|                   |                             |                  |
|-------------------|-----------------------------|------------------|
| Model Number      | CKO-M712-045011-4601        |                  |
| LED               | Oslon SSL 80                |                  |
| LES / LED Size    | Φ 3 x 3 mm                  |                  |
| FWHM (D50)        | 31°                         |                  |
| Field Angle (D10) | 67°                         |                  |
| Dimension         | Φ =45 mm, Thickness=10.9 mm |                  |
| Luminous Flux     | 631 lm                      | Measured @ 7.2 W |
| Material          | PC / UL94V0                 |                  |

## cd/klm

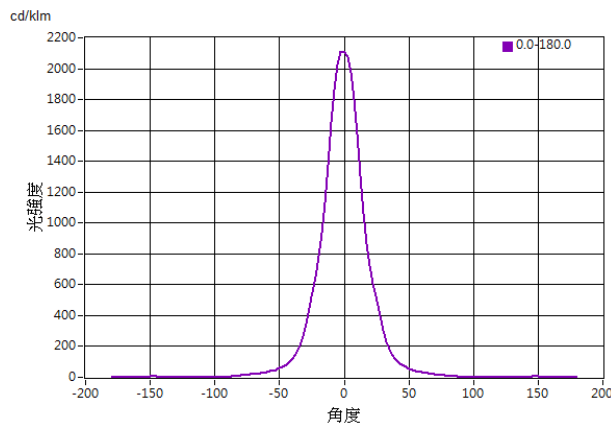

## Illuminance At Distances

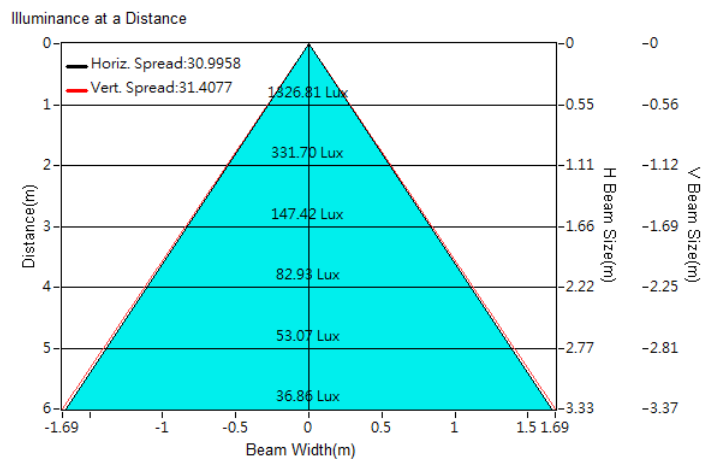



## Optical Characteristics

|                   |                             |                  |
|-------------------|-----------------------------|------------------|
| Model Number      | CKO-M712-045011-4601        |                  |
| LED               | <b>Oslon SSL 150</b>        |                  |
| LES / LED Size    | Φ 3 x 3 mm                  |                  |
| FWHM (D50)        | 32°                         |                  |
| Field Angle (D10) | 67°                         |                  |
| Dimension         | Φ =45 mm, Thickness=10.9 mm |                  |
| Luminous Flux     | 614 lm                      | Measured @ 7.3 W |
| Material          | PC / UL94V0                 |                  |

## cd/klm

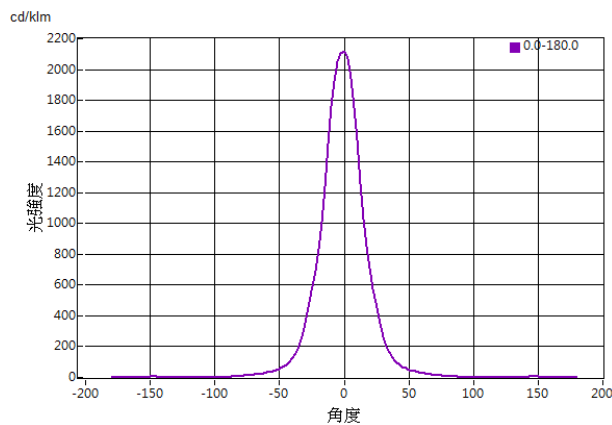

## Illuminance At Distances

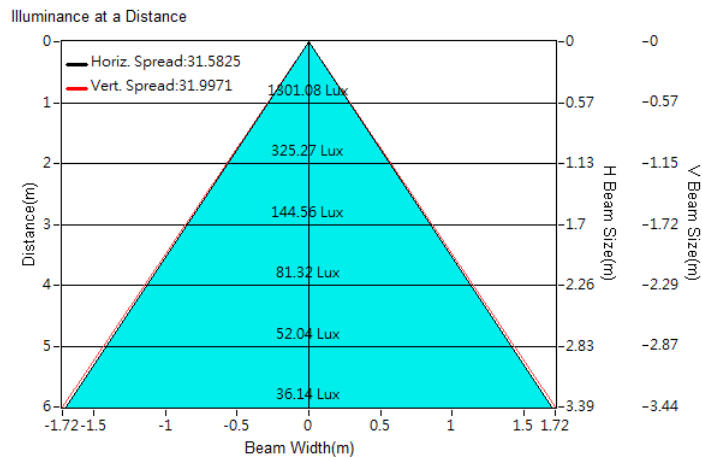



## Optical Characteristics

|                   |                             |                  |
|-------------------|-----------------------------|------------------|
| Model Number      | CKO-M712-045011-4601        |                  |
| LED               | Oslon Square                |                  |
| LES / LED Size    | Φ 3 x 3 mm                  |                  |
| FWHM (D50)        | 34°                         |                  |
| Field Angle (D10) | 70°                         |                  |
| Dimension         | Φ =45 mm, Thickness=10.9 mm |                  |
| Luminous Flux     | 629 lm                      | Measured @ 6.3 W |
| Material          | PC / UL94V0                 |                  |

## cd/klm

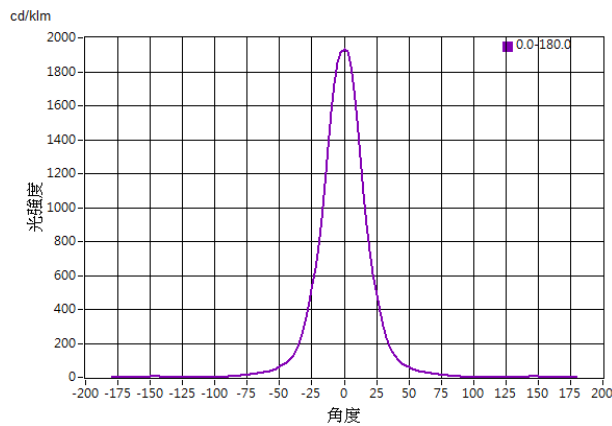

## Illuminance At Distances

