



## Product Model Number

CKO - M 8 1 8 - 1 2 0 0 2 0 - 1 0 2 7

### ✓ Model Number Definitions

**CKO-XXXX-XXXXXX-XXXX**



- A. Chun Kuang Optics Corp. Product
- B. Product Type: product abbreviation  
Ex:  
MX→Multi 33 in 1  
SW→Single Wall Washer  
CS→Soft Shading for CoB LED  
HC→Holder for CoB LED

- C. Identity Code
- D. Lens / Fixture Size  
Ex: 075026=Φ75mm / Thickness=26mm (round up)
- C. Serial Numbers

The lens datasheet is applicable for **Cree LED**, that manufactured by Chun Kuang Optics Corp.

### ✓ Dimensions (mm) : 120 x 19.9 x 8.7

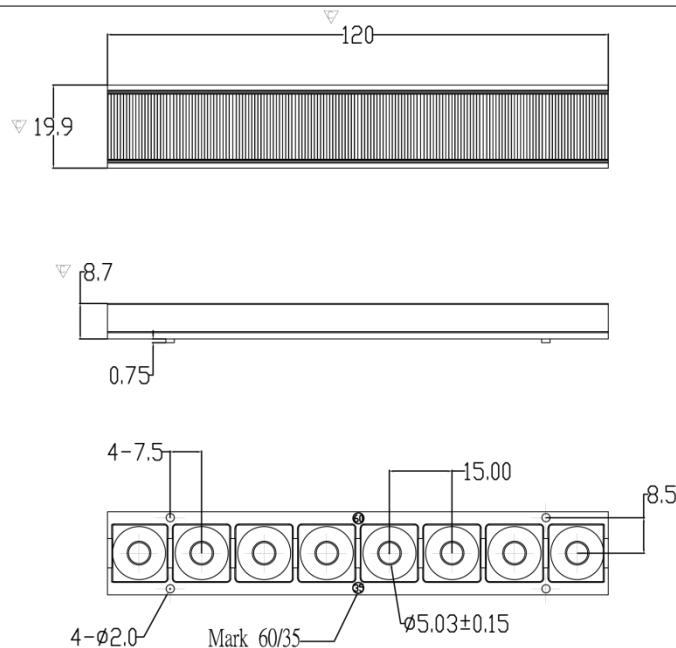

▽:Critical Dimension





## Optical Characteristics

Model Number	CKO-M818-120020-1027	
LED	<b>XT-E</b>	
LES / LED Size	3.45 x 3.45 mm	
FWHM (D50)	39° x 64°	
Dimension	wxh =120 x 19.9 mm, Thickness=8.7 mm	
Luminous Flux	348 lm	Measured @ 3.4 W
Material	PC / UL94V2	

## cd/klm

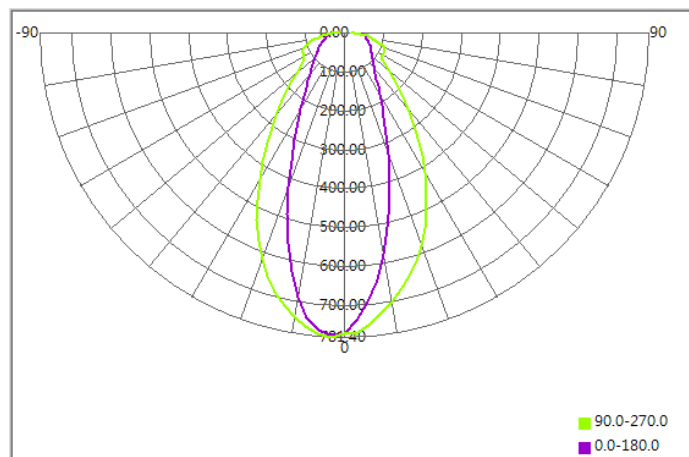

## Illuminance At Distances

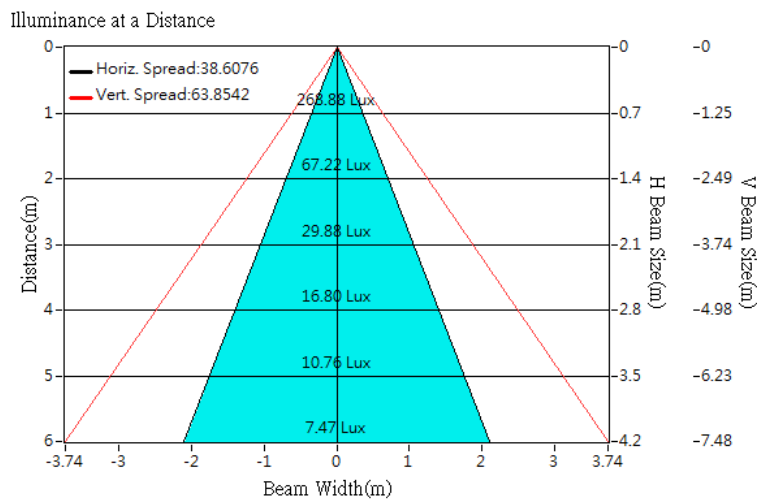



## Optical Characteristics

Model Number	CKO-M818-120020-1027	
LED	<b>XP-E2</b>	
LES / LED Size	3.5 x 3.5 mm	
FWHM (D50)	36° x 60°	
Dimension	wxh =120 x 19.9 mm, Thickness=8.7 mm	
Luminous Flux	340 lm	Measured @ 3.5 W
Material	PC / UL94V2	

## cd/klm

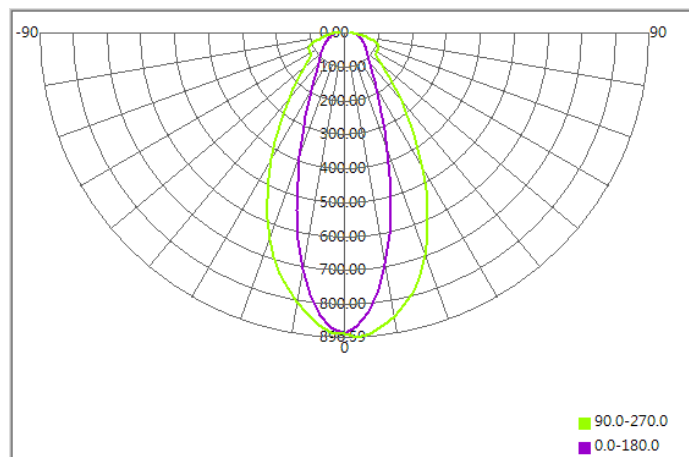

## Illuminance At Distances

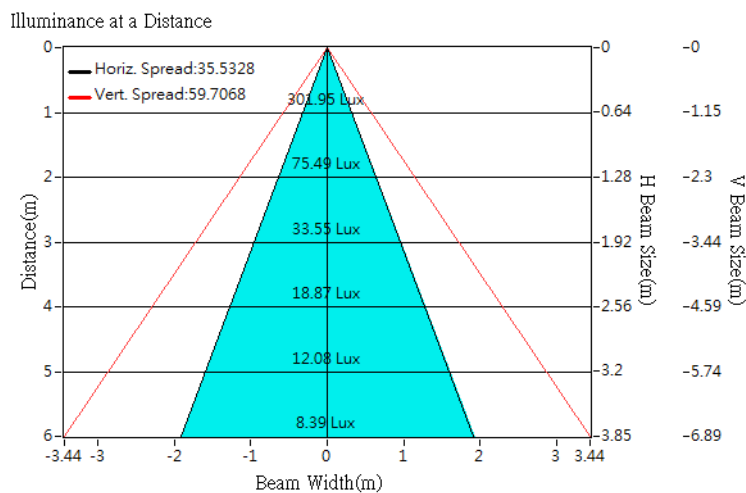



## Optical Characteristics

Model Number	CKO-M818-120020-1027	
LED	<b>XP-G2</b>	
LES / LED Size	3.5 x 3.5 mm	
FWHM (D50)	37°x 57°	
Dimension	wxh =120 x 19.9 mm, Thickness=8.7 mm	
Luminous Flux	433 lm	Measured @ 3.3 W
Material	PC / UL94V2	

## cd/klm

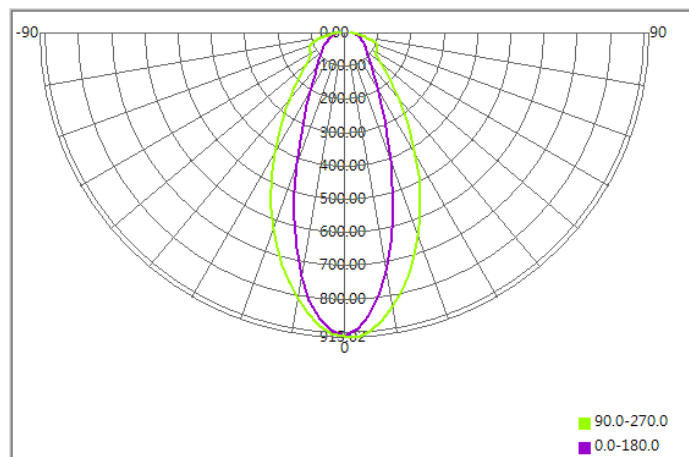

## Illuminance At Distances

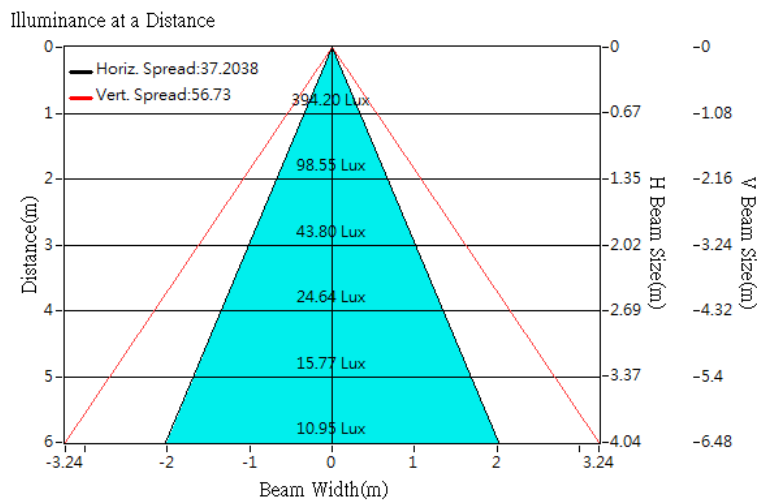



## Optical Characteristics

Model Number	CKO-M818-120020-1027	
LED	<b>XP-G3</b>	
LES / LED Size	3.5 x 3.5 mm	
FWHM (D50)	39°x 59°	
Dimension	wxh =120 x 19.9 mm, Thickness=8.7 mm	
Luminous Flux	500 lm	Measured @ 3.3 W
Material	PC / UL94V2	

## cd/klm

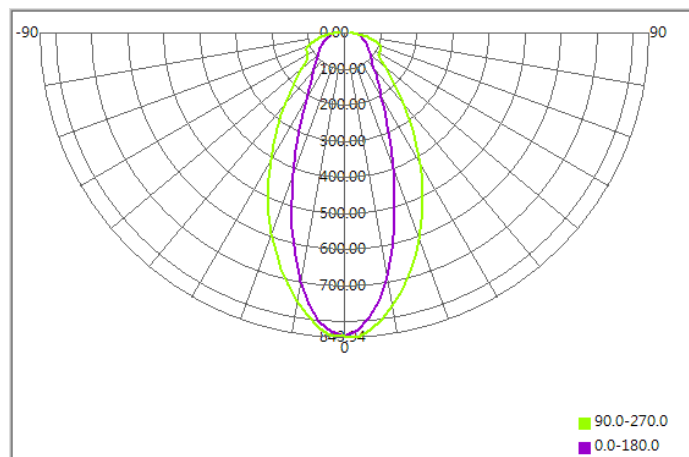

## Illuminance At Distances

