



## Product Model Number

**CKO - M 8 1 8 - 1 2 0 0 2 0 - 1 0 3 1**

### ✓ Model Number Definitions

**CKO-XXXX-XXXXXX-XXXX**

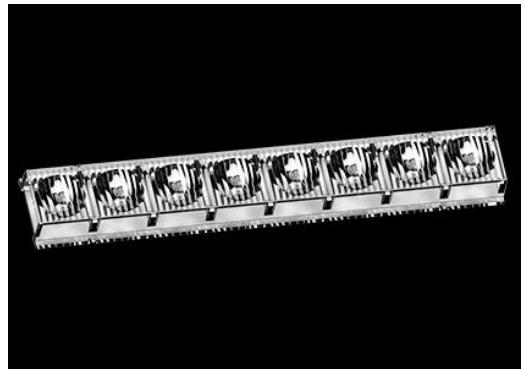

- A. Chun Kuang Optics Corp. Product
- B. Product Type: product abbreviation  
Ex:  
MX→Multi 33 in 1  
SW→Single Wall Washer  
CS→Soft Shading for CoB LED  
HC→Holder for CoB LED

- C. Identity Code
- D. Lens / Fixture Size  
Ex: 075026=Φ75mm / Thickness=26mm (round up)
- C. Serial Numbers

The lens datasheet is applicable for **Cree LED**, that manufactured by Chun Kuang Optics Corp.

### ✓ Dimensions (mm) : **120 x 19.9 x 8.7**

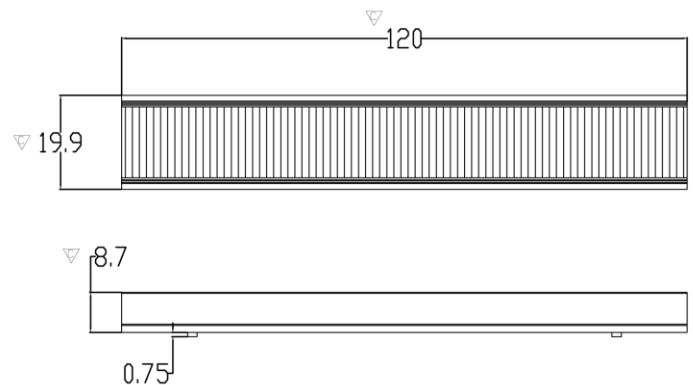
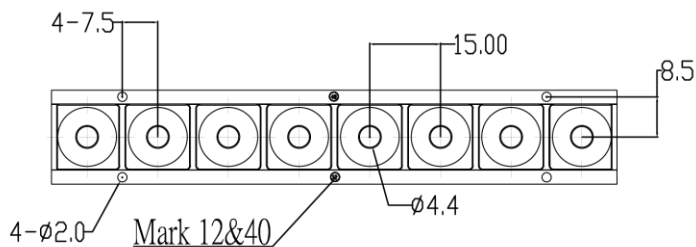

▽:Critical Dimension





## Optical Characteristics

Model Number	CKO-M818-120020-1031	
LED	<b>XQE-HI</b>	
LES / LED Size	1.6 x 1.6 mm	
FWHM (D50)	11° x 38°	
Dimension	wxh =120 x 19.9 mm, Thickness=8.7 mm	
Luminous Flux	525 lm	Measured @ 6.9 W
Material	PC / UL94V2	

## cd/klm

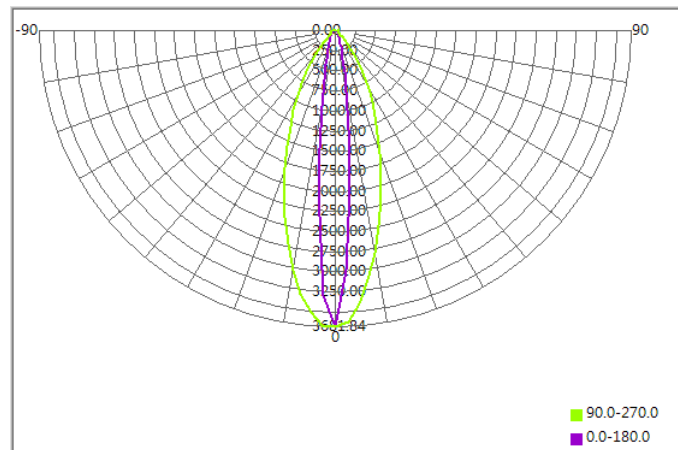

## Illuminance At Distances

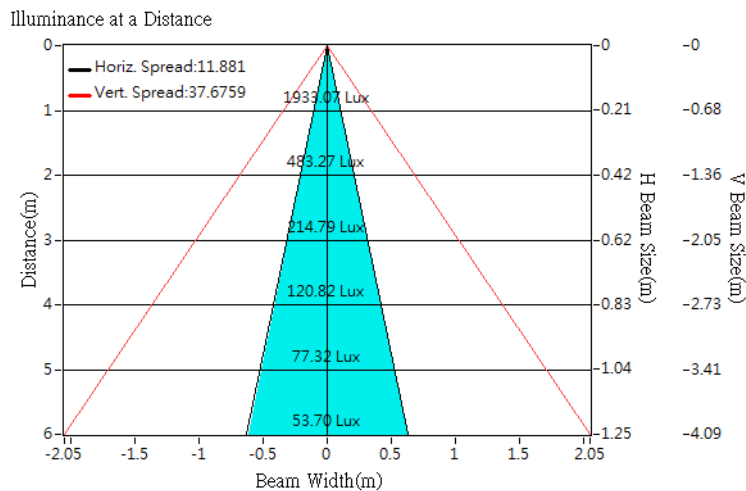



## Optical Characteristics

Model Number	CKO-M818-120020-1031	
LED	Cree J Series 3030	
LES / LED Size	3.0 x 3.0 mm	
FWHM (D50)	19°x 42°	
Dimension	wxh =120 x 19.9 mm, Thickness=8.7 mm	
Luminous Flux	709 lm	Measured @ 4.6 W
Material	PC / UL94V2	

## cd/klm

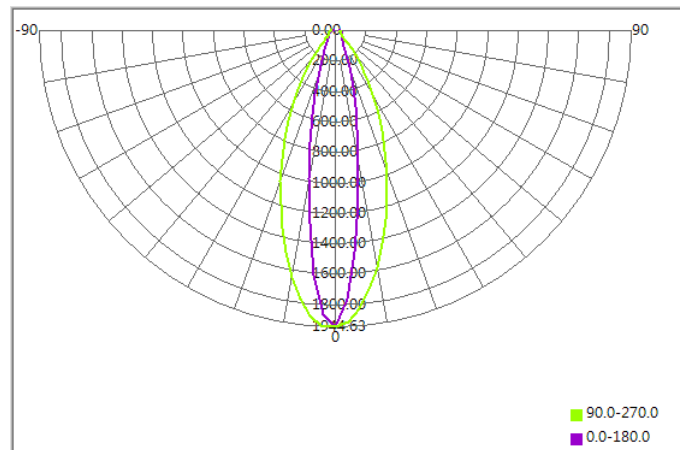

## Illuminance At Distances

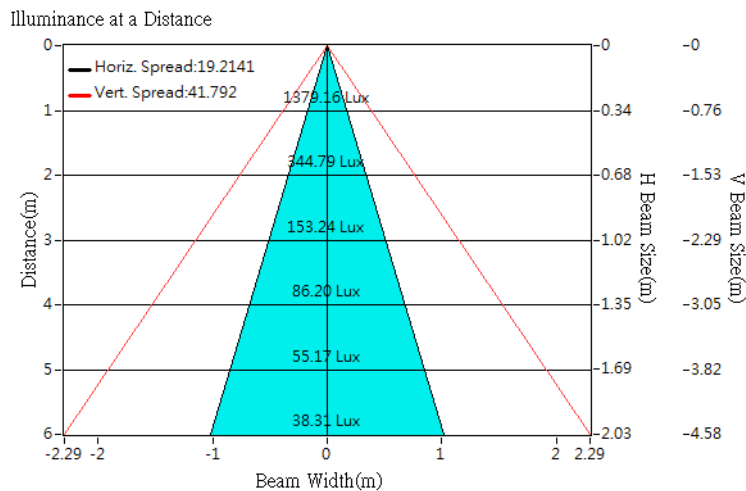



## Optical Characteristics

Model Number	CKO-M818-120020-1031	
LED	<b>XTE</b>	
LES / LED Size	3.45 x 3.45 mm	
FWHM (D50)	18° x 40°	
Dimension	wxh =120 x 19.9 mm, Thickness=8.7 mm	
Luminous Flux	445 lm	Measured @ 3.4 W
Material	PC / UL94V2	

## cd/klm

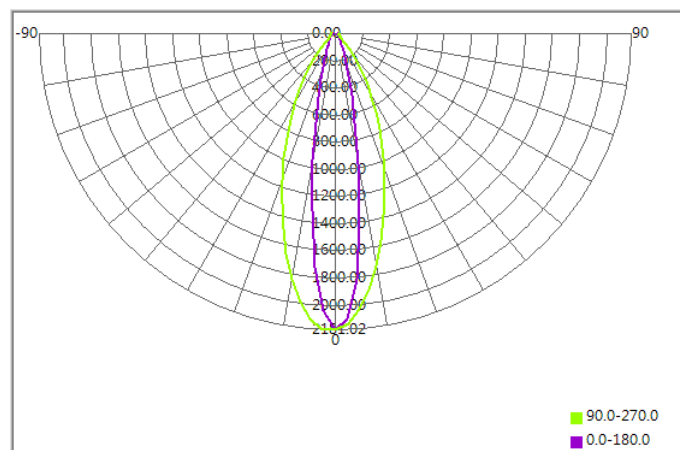

## Illuminance At Distances

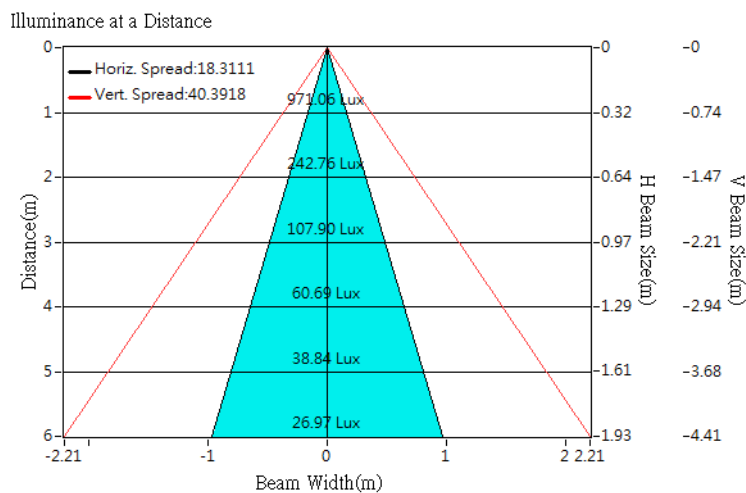



## Optical Characteristics

Model Number	CKO-M818-120020-1031	
LED	<b>XP-E2</b>	
LES / LED Size	3.5 x 3.5 mm	
FWHM (D50)	13° x 38°	
Dimension	wxh =120 x 19.9 mm, Thickness=8.7 mm	
Luminous Flux	495 lm	Measured @ 3.5 W
Material	PC / UL94V2	

## cd/klm

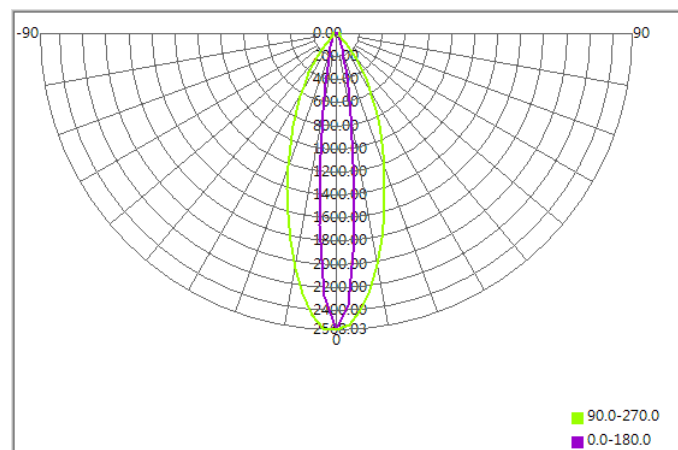

## Illuminance At Distances

