



## Product Model Number

CKO - M 8 1 8 - 1 2 0 0 2 0 - 1 0 3 2

### ✓ Model Number Definitions

**CKO-XXXX-XXXXXX-XXXX**

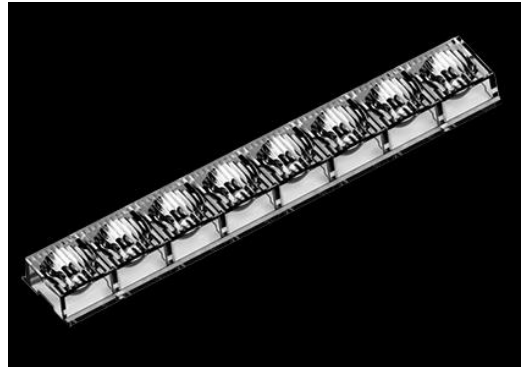

- A. Chun Kuang Optics Corp. Product
- B. Product Type: product abbreviation  
Ex:  
MX→Multi 33 in 1  
SW→Single Wall Washer  
CS→Soft Shading for CoB LED  
HC→Holder for CoB LED

- C. Identity Code
- D. Lens / Fixture Size  
Ex: 075026=Φ75mm / Thickness=26mm (round up)
- E. Serial Numbers

The lens datasheet is applicable for **Cree LED**, that manufactured by Chun Kuang Optics Corp.

### ✓ Dimensions (mm) : 120 x 19.9 x 8.7

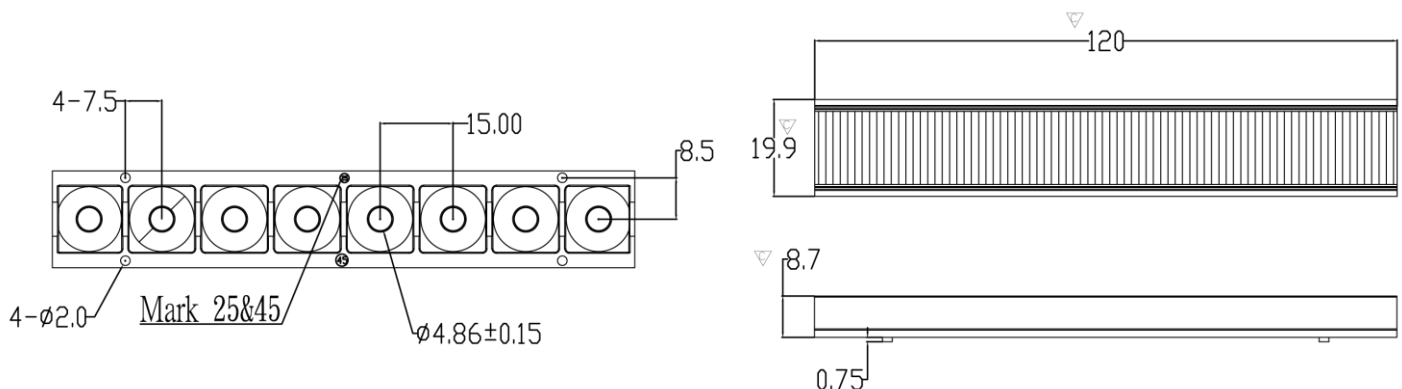

▽:Critical Dimension





## Optical Characteristics

Model Number	CKO-M818-120020-1032	
LED	<b>XQ-E-HI</b>	
LES / LED Size	1.6 x 1.6 mm	
FWHM (D50)	22° x 44°	
Dimension	wxh =120 x 19.9 mm, Thickness=8.7 mm	
Luminous Flux	602 lm	Measured @ 7.0 W
Material	PC / UL94V2	

## cd/klm

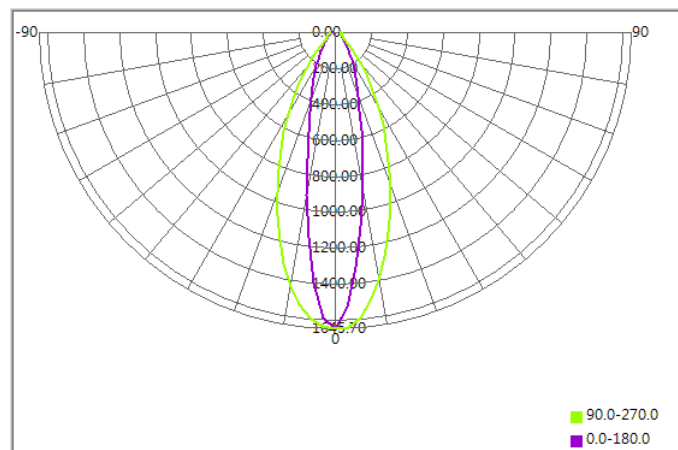

## Illuminance At Distances

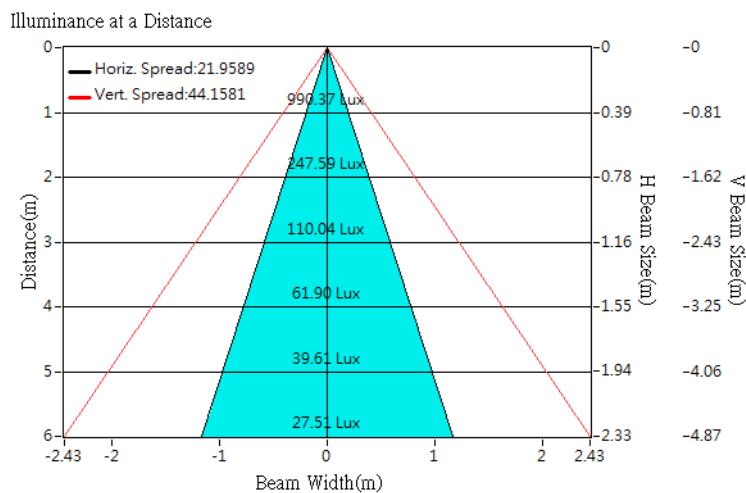



## Optical Characteristics

Model Number	CKO-M818-120020-1032	
LED	Cree J Series 3030	
LES / LED Size	3.0 x 3.0 mm	
FWHM (D50)	27° x 45°	
Dimension	wxh =120 x 19.9 mm, Thickness=8.7 mm	
Luminous Flux	601 lm	Measured @ 4.6 W
Material	PC / UL94V2	

## cd/klm

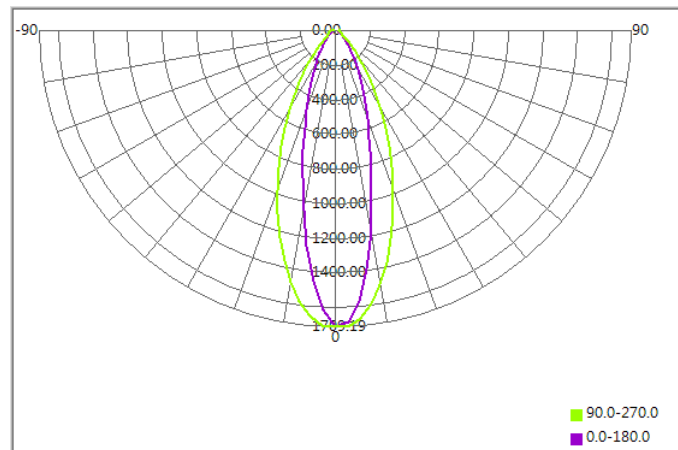

## Illuminance At Distances

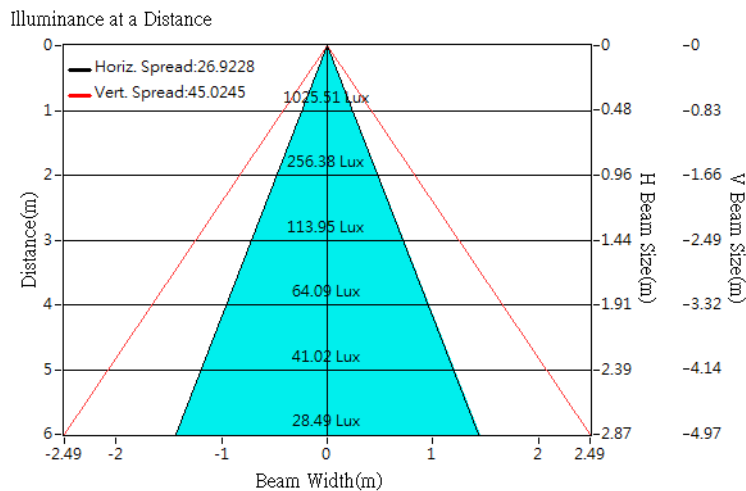



## Optical Characteristics

Model Number	CKO-M818-120020-1032	
LED	<b>XTE</b>	
LES / LED Size	3.45 x 3.45 mm	
FWHM (D50)	26° x 45°	
Dimension	wxh =120 x 19.9 mm, Thickness=8.7 mm	
Luminous Flux	401 lm	Measured @ 3.4 W
Material	PC / UL94V2	

## cd/klm

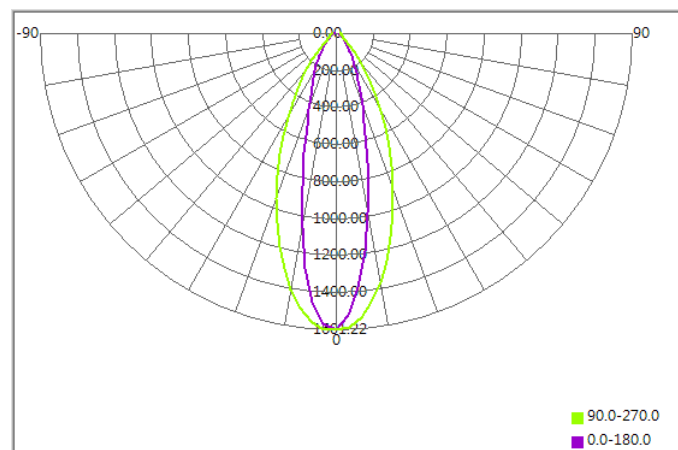

## Illuminance At Distances

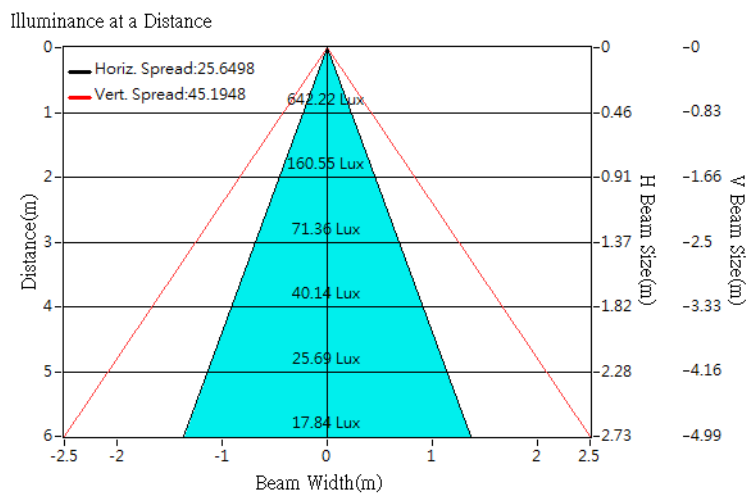



## Optical Characteristics

Model Number	CKO-M818-120020-1032	
LED	<b>XP-E2</b>	
LES / LED Size	3.5 x 3.5 mm	
FWHM (D50)	21° x 44°	
Dimension	wxh =120 x 19.9 mm, Thickness=8.7 mm	
Luminous Flux	412 lm	Measured @ 3.5 W
Material	PC / UL94V2	

## cd/klm

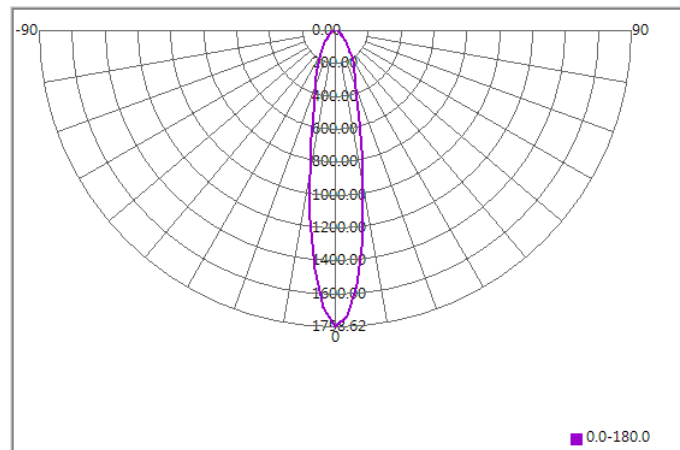

## Illuminance At Distances

