



Product Model Number

CKO - M 8 1 8 - 1 2 0 0 2 0 - 1 0 3 2

✓ Model Number Definitions

CKO-XXXX-XXXXXX-XXXX

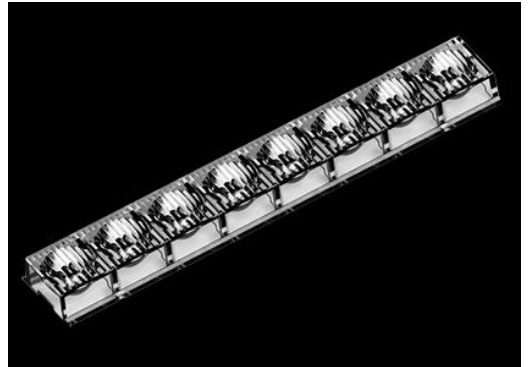

- A. Chun Kuang Optics Corp. Product
- B. Product Type: product abbreviation
Ex:
MX→Multi 33 in 1
SW→Single Wall Washer
CS→Soft Shading for CoB LED
HC→Holder for CoB LED

- C. Identity Code
- D. Lens / Fixture Size
Ex: 075026=Φ75mm / Thickness=26mm (round up)
- C. Serial Numbers

The lens datasheet is applicable for **Lumileds LED**, that manufactured by Chun Kuang Optics Corp.

✓ Dimensions (mm) : 120 x 19.9 x 8.7

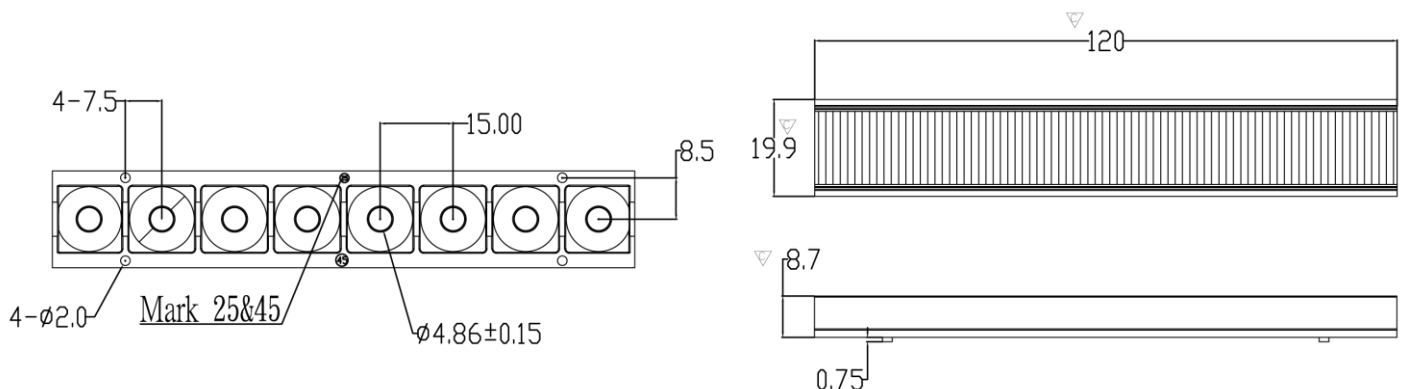

▽:Critical Dimension



Optical Characteristics

Model Number	CKO-M818-120020-1032	
LED	Luxeon 3030	
LES / LED Size	3.0 x 3.0 mm	
FWHM (D50)	28° x 45°	
Dimension	wxh =120 x 19.9 mm, Thickness=8.7 mm	
Luminous Flux	584 lm	Measured @ 4.6 W
Material	PC / UL94V2	

cd/klm

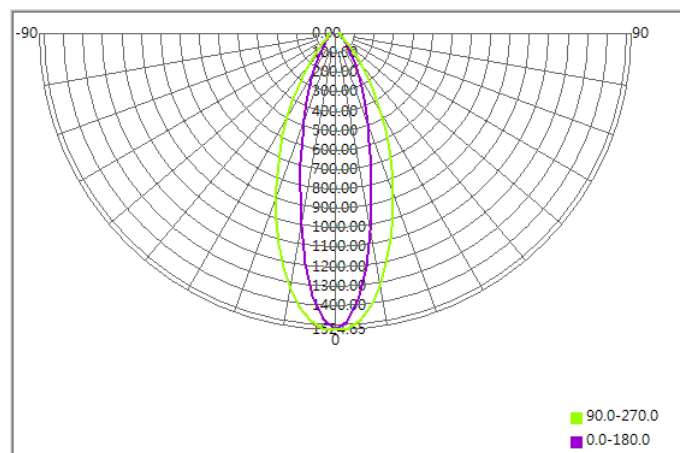

Illuminance At Distances

