



Product Model Number

CKO - M 9 1 2 - 0 6 0 0 1 1 - 3 6 0 1

✓ Model Number Definitions

CKO-XXXX-XXXXXX-XXXX



- A. Chun Kuang Optics Corp. Product
- B. Product Type: product abbreviation
Ex:
CH→CoB High Intensity
CC→CoB Compact
CS→Soft Shading for CoB LED
HC→Holder for CoB LED

- C. Identity Code
- D. Lens / Fixture Size
Ex: 075026=Φ75mm / Thickness=26mm (round up)
- C. Serial Numbers

The lens datasheet is applicable for **Cree LED**, that manufactured by Chun Kuang Optics Corp.

✓ Dimensions (mm) : Φ60 x 10.9

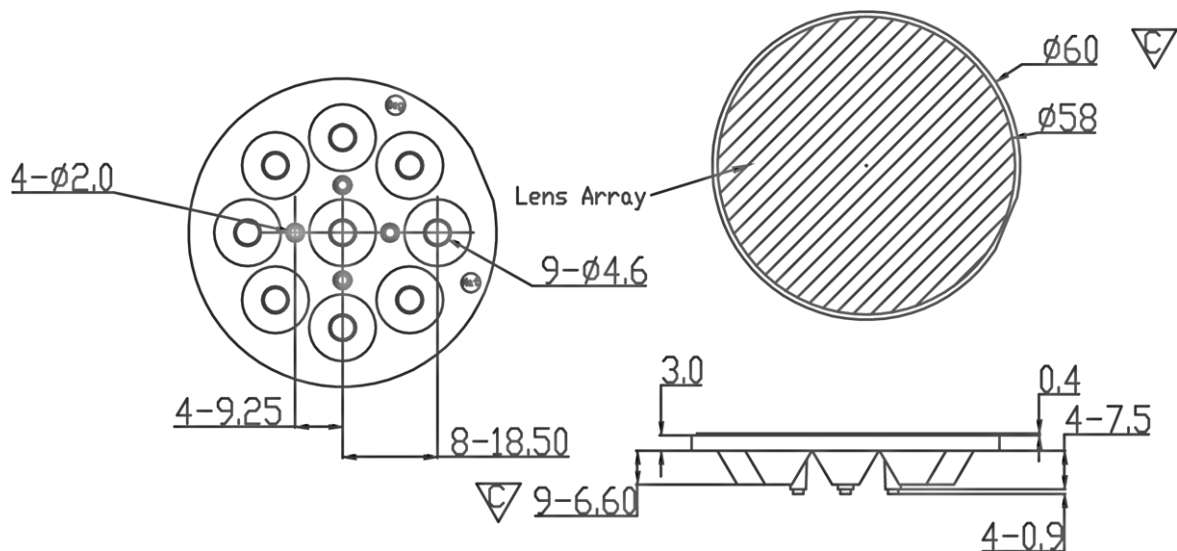

▽:Critical Dimension



Optical Characteristics

| | | |
|-------------------|-----------------------------|------------------|
| Model Number | CKO-M912-060011-3601 | |
| LED | XB-D | |
| LES / LED Size | 2.5 x 2.5 | |
| FWHM (D50) | 24° | |
| Field Angle (D10) | 47° | |
| Dimension | Φ =60 mm, Thickness=10.9 mm | |
| Luminous Flux | 690 lm | Measured @ 9.2 W |
| Material | PC / UL94V0 | |

cd/klm

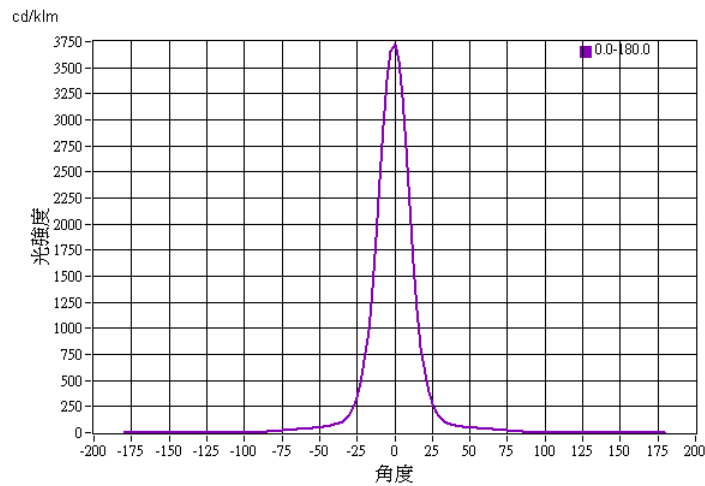

Illuminance At Distances

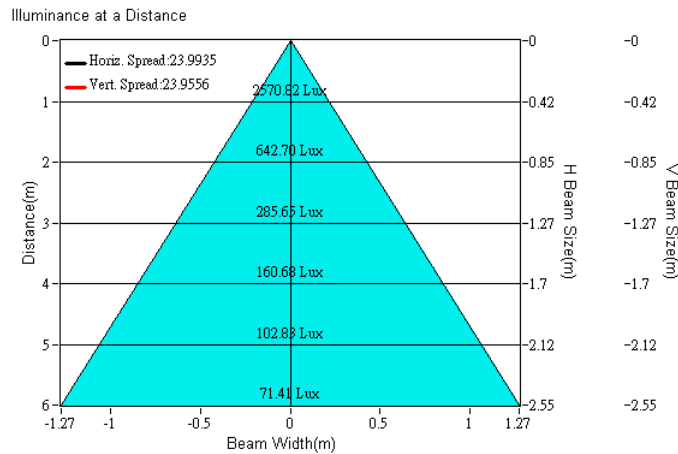



Optical Characteristics

| | | |
|-------------------|-----------------------------|------------------|
| Model Number | CKO-M912-060011-3601 | |
| LED | XB-H | |
| LES / LED Size | 2.5 x 2.5 | |
| FWHM (D50) | 24° | |
| Field Angle (D10) | 48° | |
| Dimension | Φ =60 mm, Thickness=10.9 mm | |
| Luminous Flux | 942 lm | Measured @ 8.6 W |
| Material | PC / UL94V0 | |

cd/klm

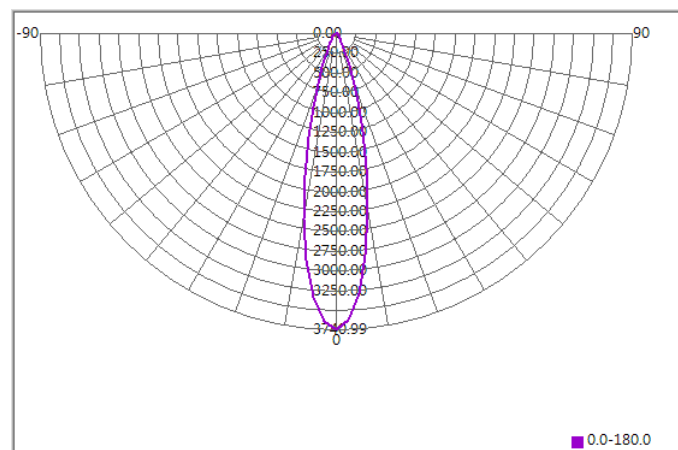

Illuminance At Distances

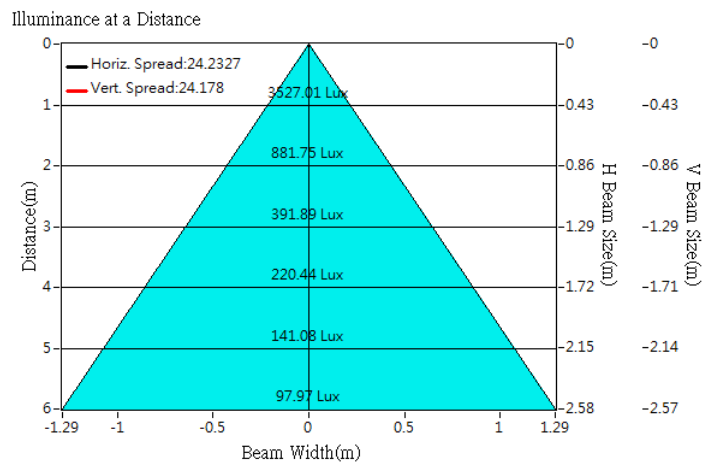



Optical Characteristics

| | | |
|-------------------|-----------------------------|------------------|
| Model Number | CKO-M912-060011-3601 | |
| LED | XP-E | |
| LES / LED Size | 3.5 x 3.5 | |
| FWHM (D50) | 23° | |
| Field Angle (D10) | 44° | |
| Dimension | Φ =60 mm, Thickness=10.9 mm | |
| Luminous Flux | 559 lm | Measured @ 9.8 W |
| Material | PC / UL94V0 | |

cd/klm

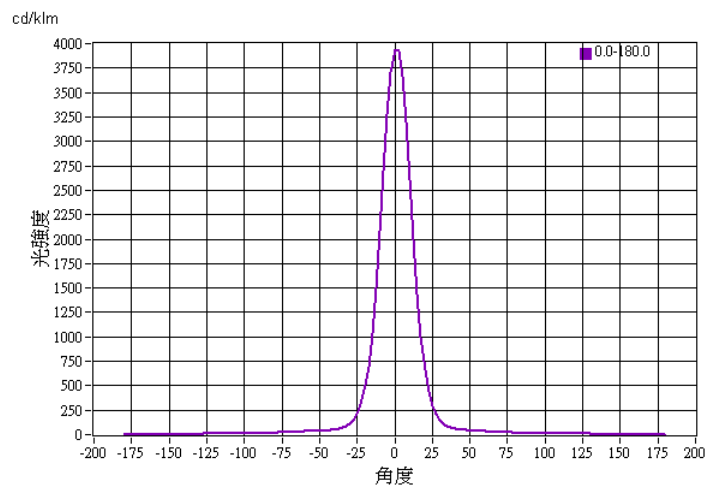

Illuminance At Distances

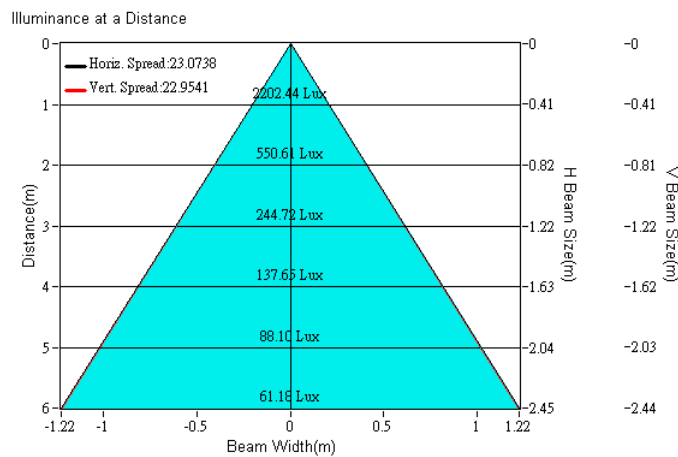



Optical Characteristics

| | | |
|-------------------|-----------------------------|------------------|
| Model Number | CKO-M912-060011-3601 | |
| LED | XP-G | |
| LES / LED Size | 3.5 x 3.5 | |
| FWHM (D50) | 26° | |
| Field Angle (D10) | 49° | |
| Dimension | Φ =60 mm, Thickness=10.9 mm | |
| Luminous Flux | 810 lm | Measured @ 8.6 W |
| Material | PC / UL94V0 | |

cd/klm

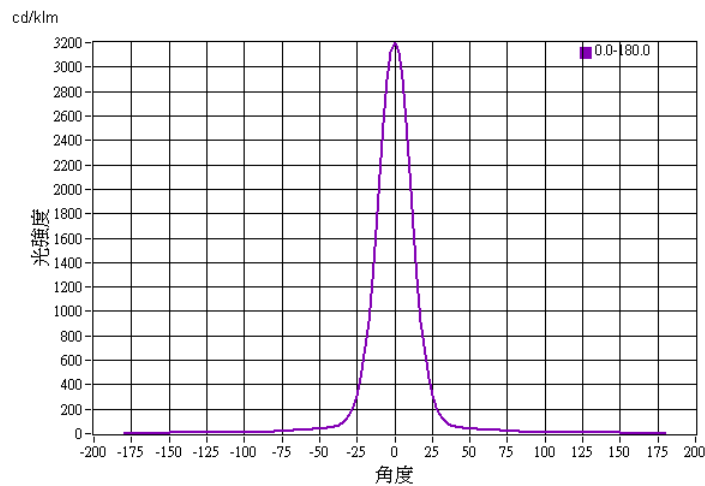

Illuminance At Distances

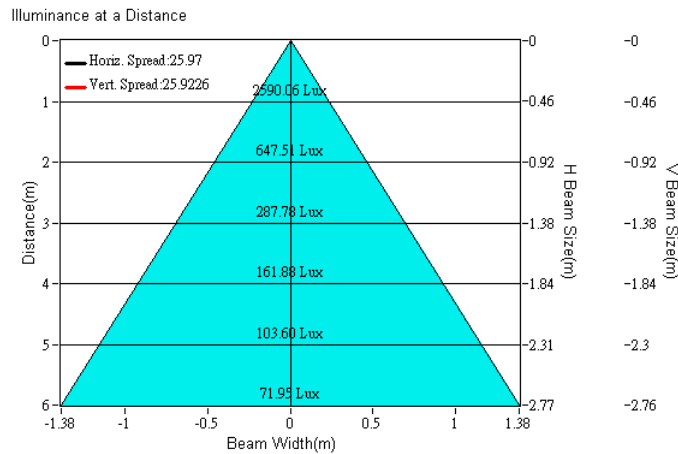



Optical Characteristics

| | | |
|-------------------|-----------------------------|------------------|
| Model Number | CKO-M912-060011-3601 | |
| LED | XP-G2 | |
| LES / LED Size | 3.5 x 3.5 | |
| FWHM (D50) | 25° | |
| Field Angle (D10) | 49° | |
| Dimension | Φ =60 mm, Thickness=10.9 mm | |
| Luminous Flux | 810 lm | Measured @ 8.6 W |
| Material | PC / UL94V0 | |

cd/klm

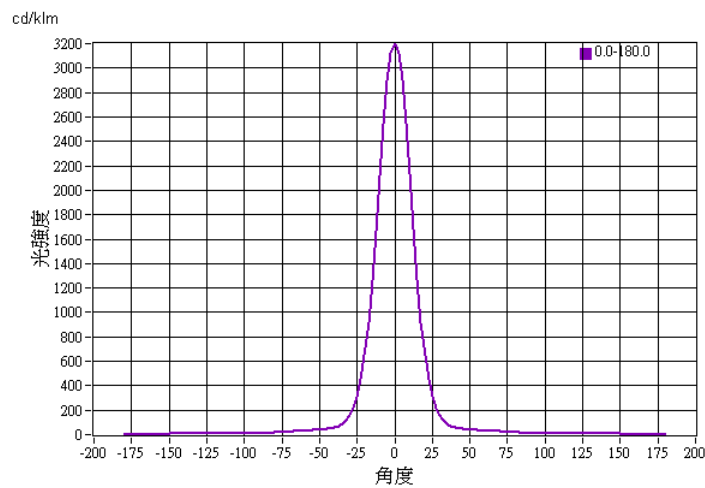

Illuminance At Distances

