



Product Model Number

CKO-MB12-060011-3901

✓ Model Number Definitions

CKO-XXXX-XXXXXX-XXXX

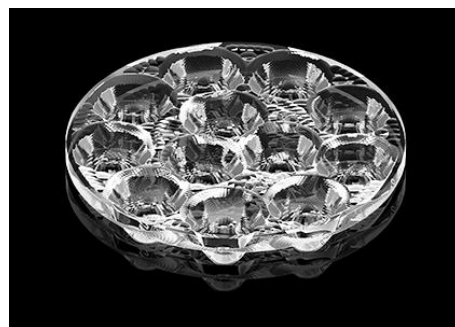

- A. Chun Kuang Optics Corp. Product
- B. Product Type: product abbreviation
Ex:
CH→CoB High Intensity
CC→CoB Compact
CS→Soft Shading for CoB LED
HC→Holder for CoB LED

- C. Identity Code
- D. Lens / Fixture Size
Ex: 075026=Φ75mm / Thickness=26mm (round up)
- C. Serial Numbers

The lens datasheet is applicable for **Cree LED**, that manufactured by Chun Kuang Optics Corp.

✓ Dimensions (mm) : Φ60 x 10.9

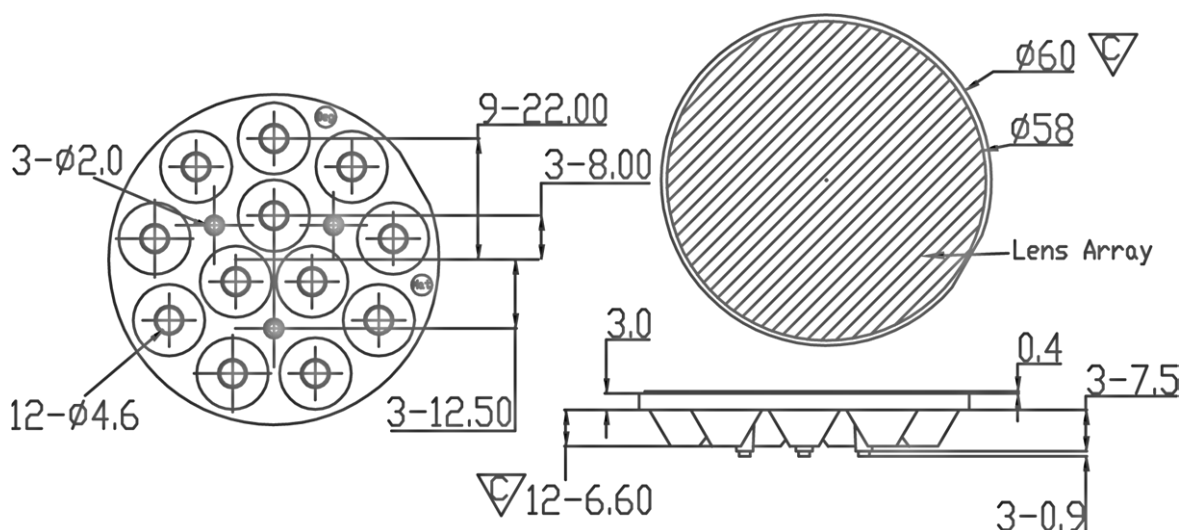

▽:Critical Dimension



Optical Characteristics

| | | |
|-------------------|-----------------------------|-------------------|
| Model Number | CKO-MB12-060011-3901 | |
| LED | XB-D | |
| LES / LED Size | 2.5 x 2.5 | |
| FWHM (D50) | 16° | |
| Field Angle (D10) | 36° | |
| Dimension | Φ =60 mm, Thickness=10.9 mm | |
| Luminous Flux | 1026 lm | Measured @ 12.4 W |
| Material | PC / UL94V0 | |

cd/klm

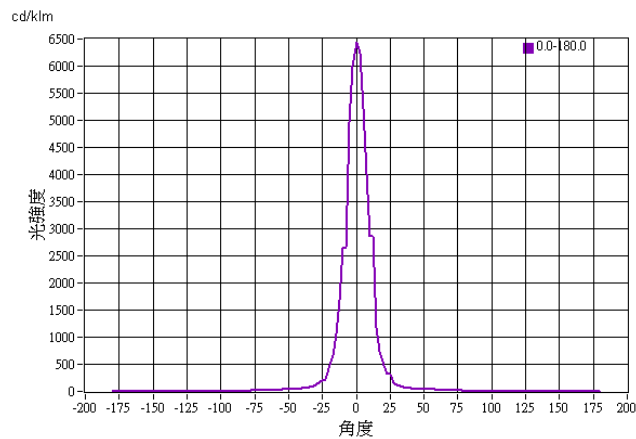

Illuminance At Distances

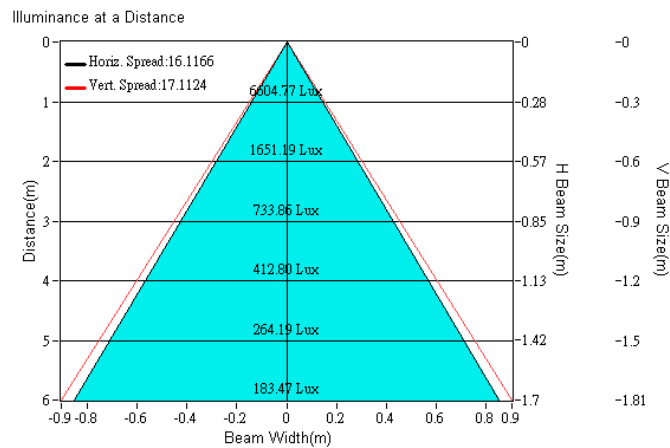



Optical Characteristics

| | | |
|-------------------|-----------------------------|-------------------|
| Model Number | CKO-MB12-060011-3901 | |
| LED | XB-H | |
| LES / LED Size | 2.5 x 2.5 | |
| FWHM (D50) | 18° | |
| Field Angle (D10) | 37° | |
| Dimension | Φ =60 mm, Thickness=10.9 mm | |
| Luminous Flux | 1194 lm | Measured @ 11.5 W |
| Material | PC / UL94V0 | |

cd/klm

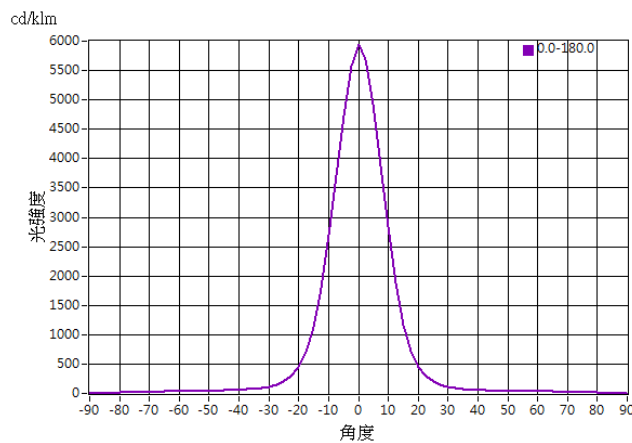

Illuminance At Distances

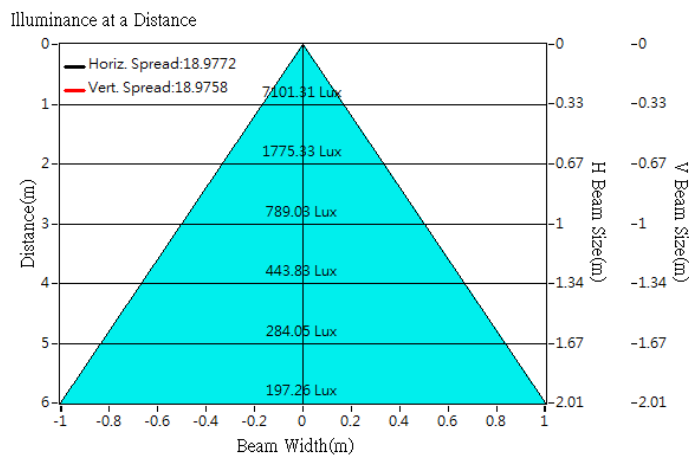



Optical Characteristics

| | | |
|-------------------|-----------------------------|-------------------|
| Model Number | CKO-MB12-060011-3901 | |
| LED | XP-E | |
| LES / LED Size | 3.5 x 3.5 | |
| FWHM (D50) | 18° | |
| Field Angle (D10) | 34° | |
| Dimension | Φ =60 mm, Thickness=10.9 mm | |
| Luminous Flux | 682 lm | Measured @ 12.5 W |
| Material | PC / UL94V0 | |

cd/klm

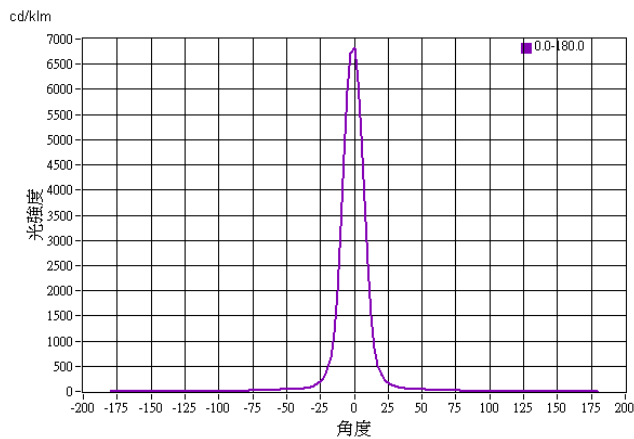

Illuminance At Distances

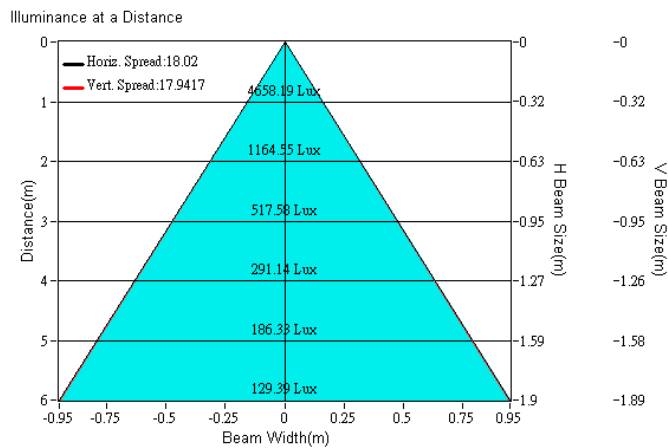



Optical Characteristics

| | | |
|-------------------|-----------------------------|-------------------|
| Model Number | CKO-MB12-060011-3901 | |
| LED | XP-G | |
| LES / LED Size | 3.5 x 3.5 | |
| FWHM (D50) | 22° | |
| Field Angle (D10) | 40° | |
| Dimension | Φ =60 mm, Thickness=10.9 mm | |
| Luminous Flux | 966 lm | Measured @ 11.5 W |
| Material | PC / UL94V0 | |

cd/klm

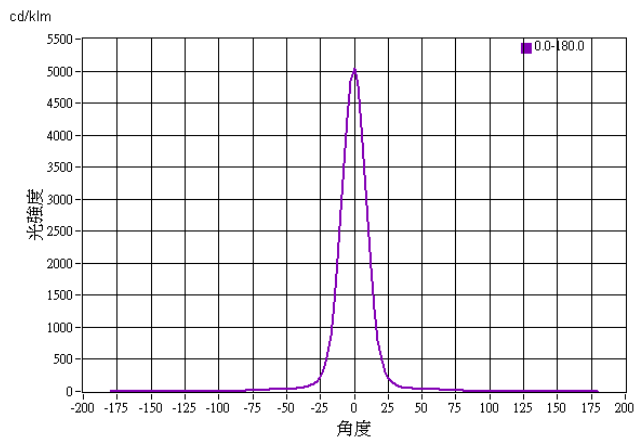

Illuminance At Distances

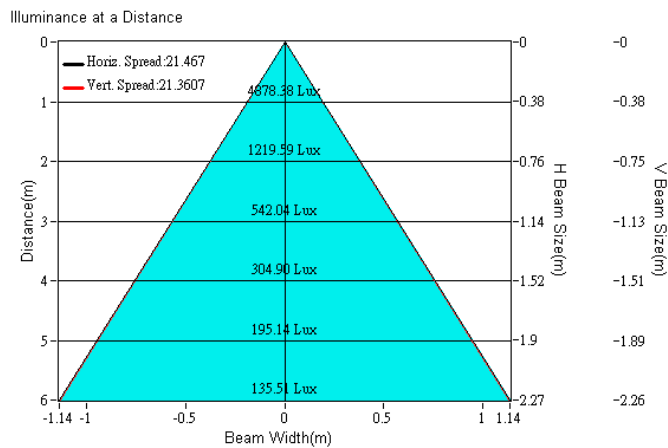



Optical Characteristics

| | | |
|-------------------|-----------------------------|-------------------|
| Model Number | CKO-MB12-060011-3901 | |
| LED | XP-G2 | |
| LES / LED Size | 3.5 x 3.5 | |
| FWHM (D50) | 20° | |
| Field Angle (D10) | 39° | |
| Dimension | Φ =60 mm, Thickness=10.9 mm | |
| Luminous Flux | 1310 lm | Measured @ 11.7 W |
| Material | PC / UL94V0 | |

cd/klm

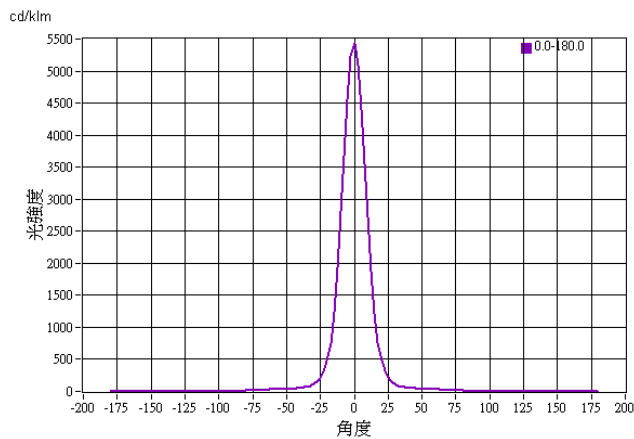

Illuminance At Distances

