



## Product Model Number

CKO-MB12-060011-4001

### ✓ Model Number Definitions

**CKO-XXXX-XXXXXX-XXXX**

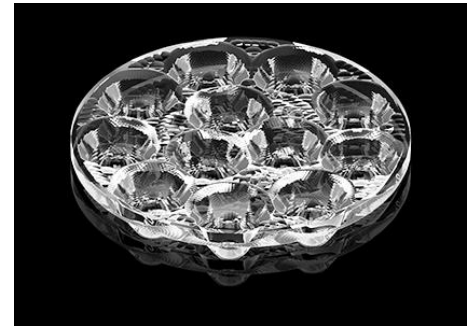

- A. Chun Kuang Optics Corp. Product
- B. Product Type: product abbreviation  
Ex:  
CH→CoB High Intensity  
CC→CoB Compact  
CS→Soft Shading for CoB LED  
HC→Holder for CoB LED

- C. Identity Code
- D. Lens / Fixture Size  
Ex: 075026=Φ75mm / Thickness=26mm (round up)
- E. Serial Numbers

The lens datasheet is applicable for **Osram LED**, that manufactured by Chun Kuang Optics Corp.

### ✓ Dimensions (mm) : Φ60 x 10.9

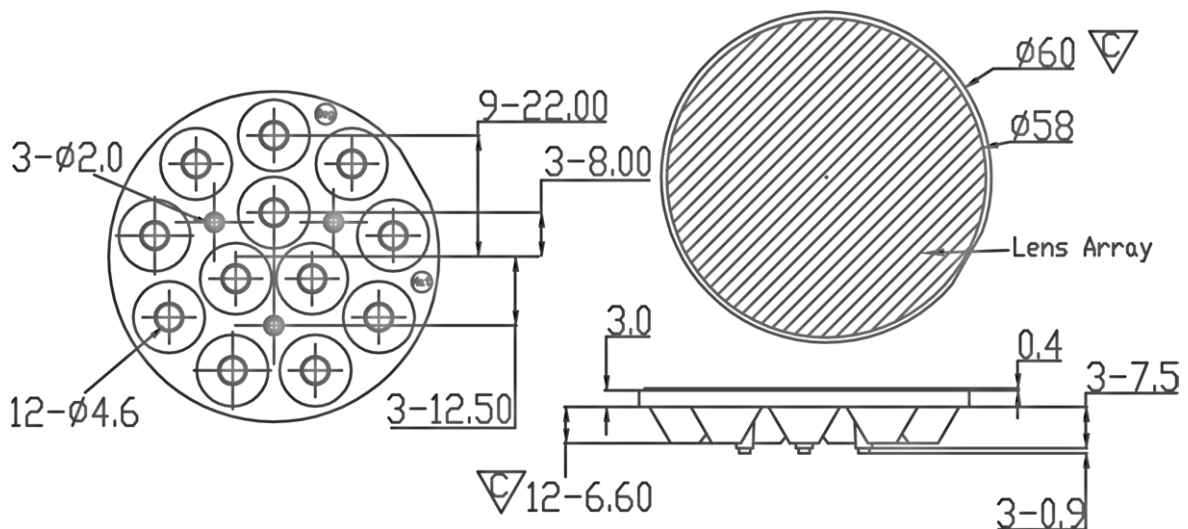

▽:Critical Dimension





## Optical Characteristics

Model Number	CKO-MB12-060011-4001	
LED	<b>Duris S5</b>	
LES / LED Size	Φ 3 x 3 mm	
FWHM (D50)	23°	
Field Angle (D10)	46°	
Dimension	Φ =45 mm, Thickness=10.9 mm	
Luminous Flux	1060 lm	Measured @ 10.9 W
Material	PC / UL94V0	

## cd/klm

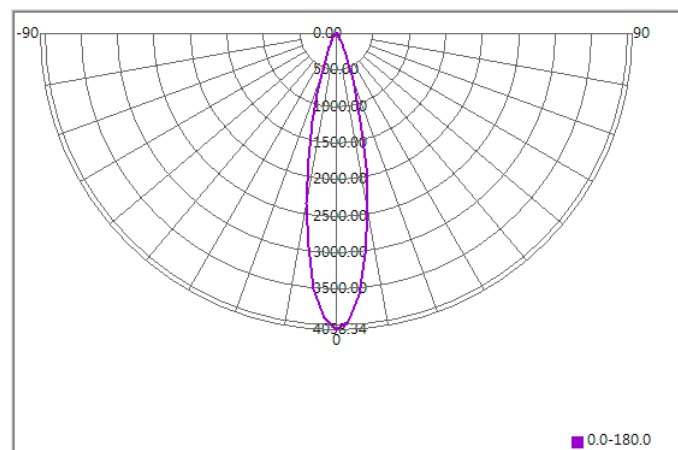

## Illuminance At Distances

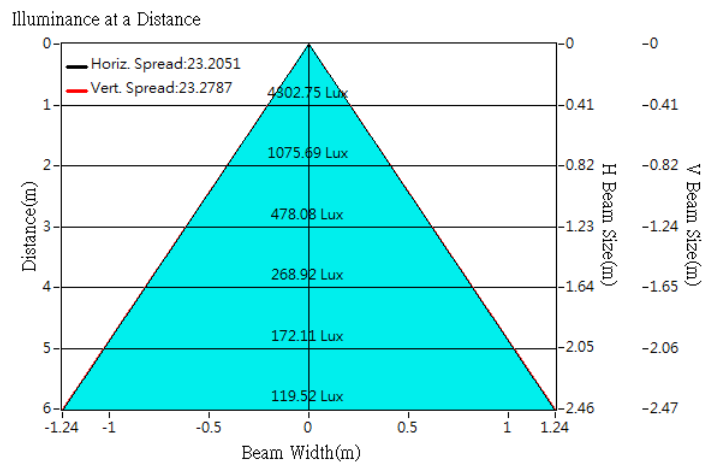



## Optical Characteristics

Model Number	CKO-MB12-060011-4001	
LED	Oslon Square	
LES / LED Size	Φ 3 x 3 mm	
FWHM (D50)	23°	
Field Angle (D10)	45°	
Dimension	Φ =45 mm, Thickness=10.9 mm	
Luminous Flux	1070 lm	Measured @ 10.8 W
Material	PC / UL94V0	

## cd/klm

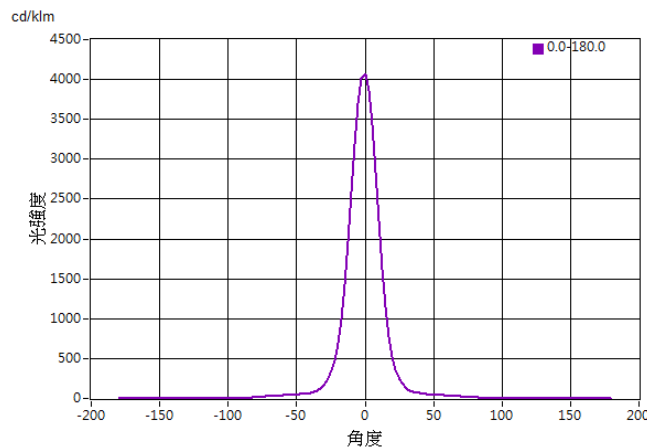

## Illuminance At Distances

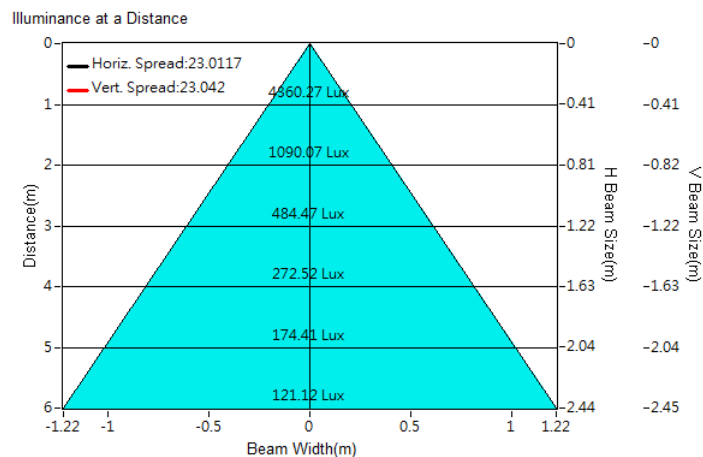



## Optical Characteristics

Model Number	CKO-MB12-060011-4001	
LED	Oslon SSL 80	
LES / LED Size	Φ 3 x 3 mm	
FWHM (D50)	21°	
Field Angle (D10)	42°	
Dimension	Φ =45 mm, Thickness=10.9 mm	
Luminous Flux	1042 lm	Measured @ 12.1 W
Material	PC / UL94V0	

## cd/klm

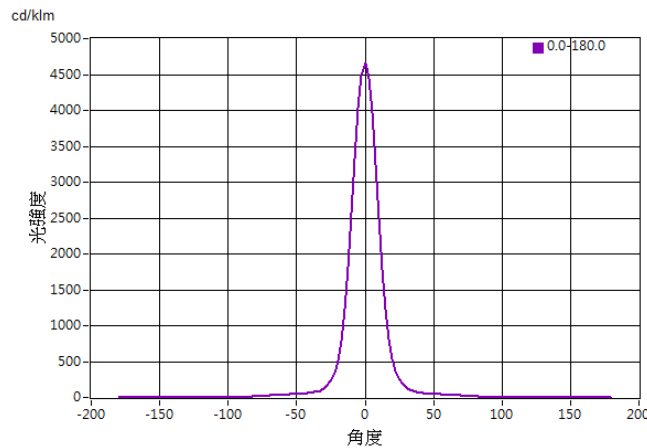

## Illuminance At Distances

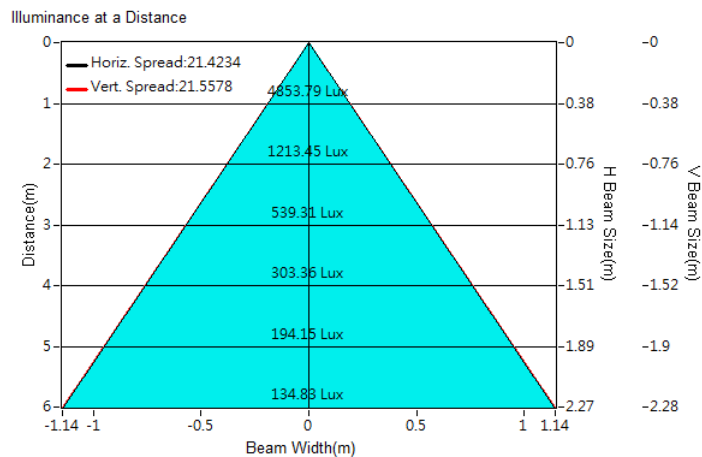



## Optical Characteristics

Model Number	CKO-MB12-060011-4001	
LED	<b>Oslon SSL 150</b>	
LES / LED Size	Φ 3 x 3 mm	
FWHM (D50)	21°	
Field Angle (D10)	41°	
Dimension	Φ =45 mm, Thickness=10.9 mm	
Luminous Flux	1081 lm	Measured @ 12.4 W
Material	PC / UL94V0	

## cd/klm

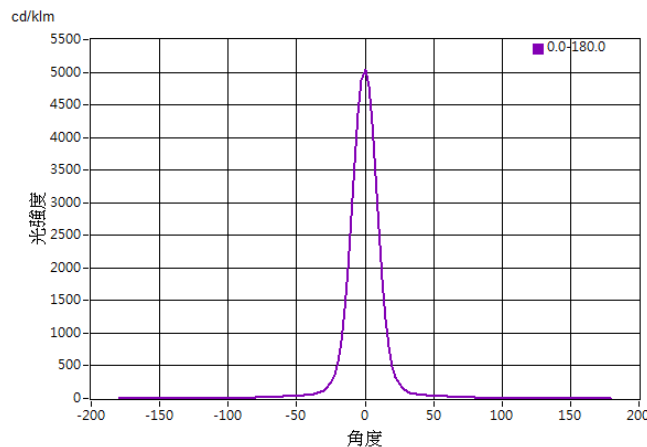

## Illuminance At Distances

