



Product Model Number

CKO-SA15-060027-4209

✓ Model Number Definitions

CKO-XXXX-XXXXXX-XXXX

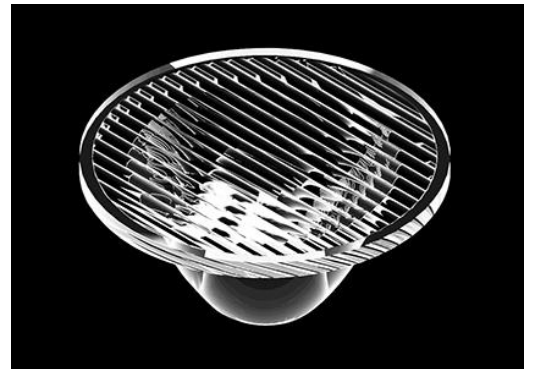

- A. Chun Kuang Optics Corp. Product
- B. Product Type: product abbreviation
Ex:
CH→CoB High Intensity
CC→CoB Compact
CS→Soft Shading for CoB LED
HC→Holder for CoB LED

- C. Identity Code
- D. Lens / Fixture Size
Ex: 075026=Φ75mm / Thickness=26mm (round up)
- E. Serial Numbers

The lens datasheet is applicable for **Cree LED**, that manufactured by Chun Kuang Optics Corp.

✓ Dimensions (mm) : **Φ60 x 26.85**

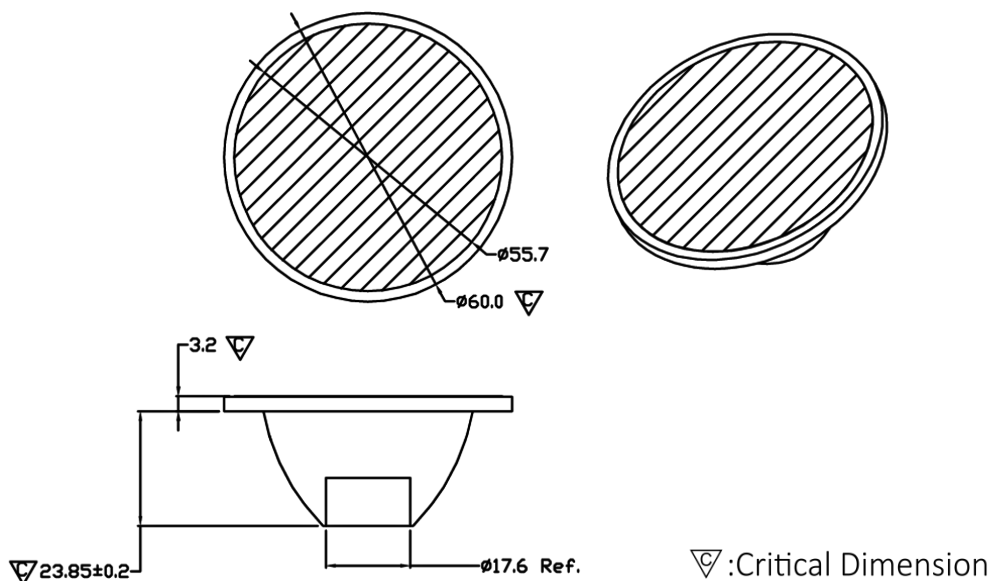



✓ Optical Characteristics – Angle Performances

| Cree | LED LES (mm) | FWHM (degrees) | Field Angle (degrees) | "H"mm |
|---------|--------------|----------------|-----------------------|-------|
| CXA1512 | Φ9 | 29°x41° | 48°x82° | 3.65 |
| CXB1512 | Φ9 | 30°x41° | 46°x81° | 3.65 |
| CMA1516 | Φ9 | 30°x41° | 46°x81° | 3.65 |
| CXB1520 | Φ9 | 31°x41° | 47°x82° | 3.65 |
| CMT1407 | Φ9.8 | 29°x41° | 48°x82° | 3.65 |
| CMT1412 | Φ9.8 | 31°x42° | 48°x82° | 3.65 |
| CMT1420 | Φ9.8 | 29°x41° | 48°x82° | 3.65 |
| CXA1816 | Φ12 | 34°x43° | 54°x85° | 3.65 |
| CXB1816 | Φ12 | 34°x42° | 54°x84° | 3.65 |
| CXA1820 | Φ12 | 34°x42° | 55°x85° | 3.65 |
| CXB1820 | Φ12 | 35°x43° | 54°x85° | 3.65 |
| CMA1825 | Φ12 | 35°x43° | 59°x86° | 3.65 |
| CXA1830 | Φ14 | 35°x44° | 62°x87° | 3.65 |
| CXB1830 | Φ14 | 37°x44° | 61°x86° | 3.65 |
| CMA1840 | Φ14 | 38°x44° | 65°x88° | 3.65 |
| CMT1922 | Φ14.5 | 37°x45° | 69°x89° | 3.65 |
| CMT1925 | Φ14.5 | 37°x45° | 64°x88° | 3.65 |
| CMT1930 | Φ14.5 | 37°x45° | 56°x85° | 3.65 |
| CMT1945 | Φ14.5 | 37°x45° | 67°x89° | 3.65 |
| | | | | |
| | | | | |
| | | | | |
| | | | | |
| | | | | |
| | | | | |
| | | | | |
| | | | | |
| | | | | |



Optical Characteristics

| | | |
|-------------------|------------------------------|-----------------------|
| Model Number | CKO-SA15-060027-4209 | <p>"H" definition</p> |
| LED | CXA1512 | |
| LES / LED Size | Φ 9 mm | |
| FWHM (D50) | 29°x41° | |
| Field Angle (D10) | 48°x82° | |
| H (distance) | 3.65 mm | |
| Dimension | Φ =60 mm, Thickness=26.85 mm | |
| Luminous Flux | 1335 lm | |
| Material | PC / UL94V2 | |

cd/klm

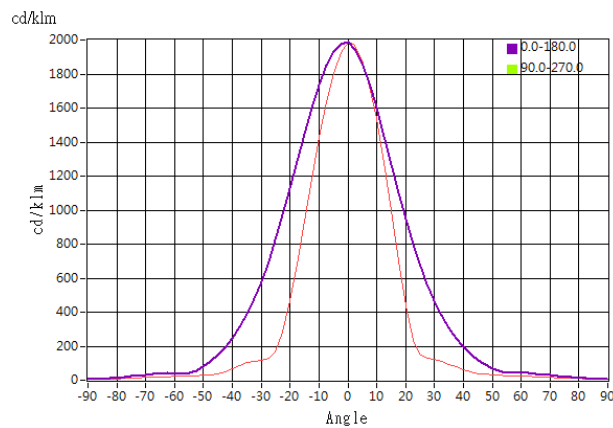

Illuminance At Distances

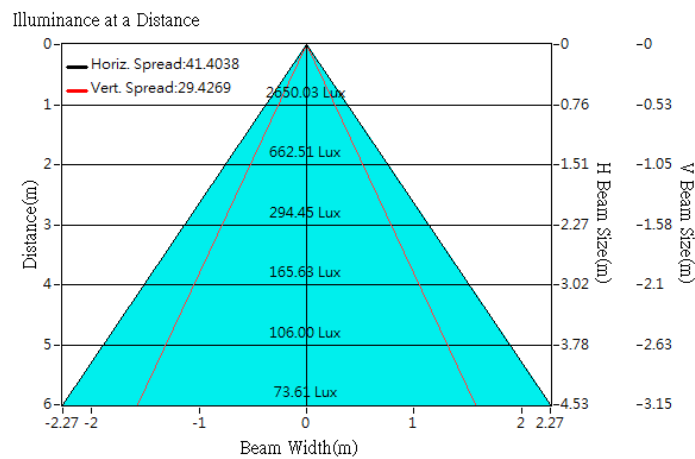



Optical Characteristics

| | | | |
|-------------------|------------------------------|-------------------|-----------------------|
| Model Number | CKO-SA15-060027-4209 | | <p>"H" definition</p> |
| LED | CXB1512 | | |
| LES / LED Size | Φ 9 mm | | |
| FWHM (D50) | 30°x41° | | |
| Field Angle (D10) | 48°x82° | | |
| H (distance) | 3.65 mm | | |
| Dimension | Φ =60 mm, Thickness=26.85 mm | | |
| Luminous Flux | 1328 lm | Measured @ 12.1 W | |
| Material | PC / UL94V2 | | |

cd/klm

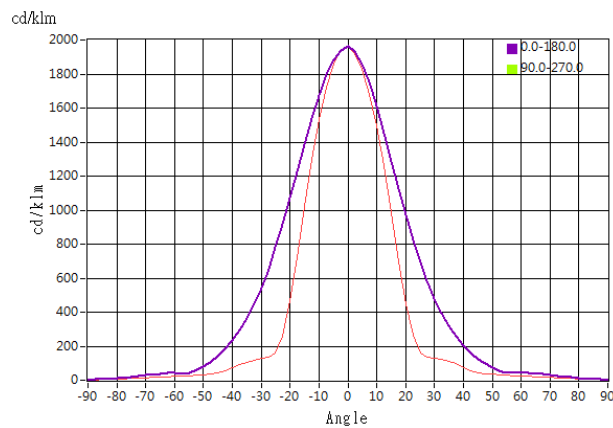

Illuminance At Distances

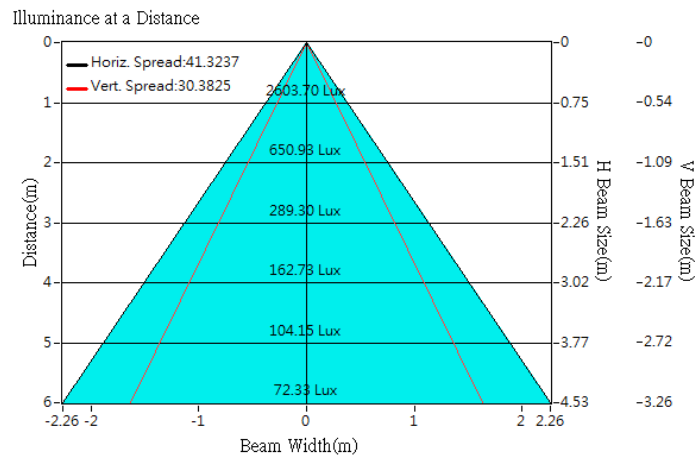

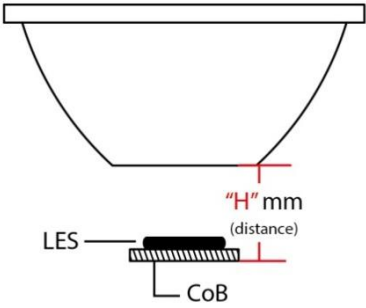

Optical Characteristics

| | | | |
|-------------------|------------------------------|-------------------|--|
| Model Number | CKO-SA15-060027-4209 | | <p>"H" definition</p>  |
| LED | CMA1516 | | |
| LES / LED Size | Φ 9 mm | | |
| FWHM (D50) | 31°x42° | | |
| Field Angle (D10) | 49°x83° | | |
| H (distance) | 3.65 mm | | |
| Dimension | Φ =60 mm, Thickness=26.85 mm | | |
| Luminous Flux | 1817 lm | Measured @ 15.9 W | |
| Material | PC / UL94V2 | | |

cd/klm

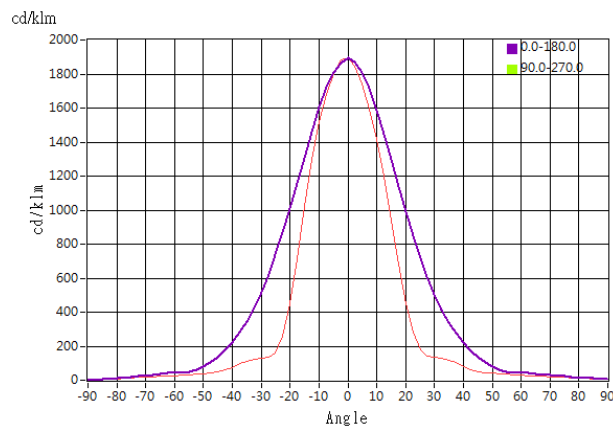

Illuminance At Distances

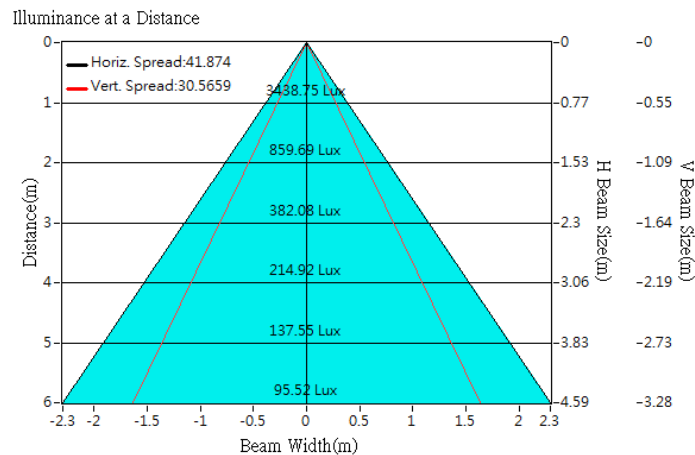



Optical Characteristics

| | | | |
|-------------------|------------------------------|-------------------|-----------------------|
| Model Number | CKO-SA15-060027-4209 | | <p>"H" definition</p> |
| LED | CXB1520 | | |
| LES / LED Size | Φ 9 mm | | |
| FWHM (D50) | 31°x41° | | |
| Field Angle (D10) | 48°x82° | | |
| H (distance) | 3.65 mm | | |
| Dimension | Φ =60 mm, Thickness=26.85 mm | | |
| Luminous Flux | 1909 lm | Measured @ 16.5 W | |
| Material | PC / UL94V2 | | |

cd/klm

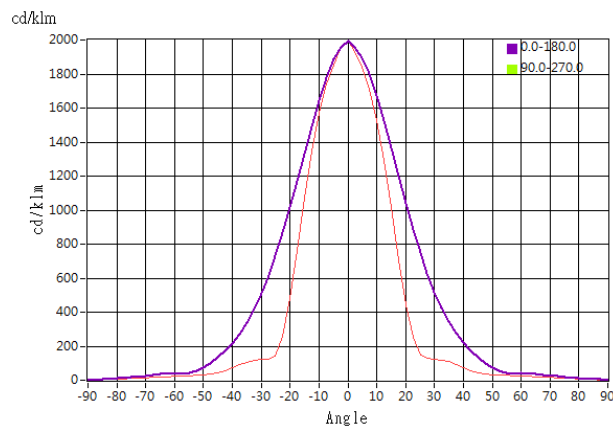

Illuminance At Distances

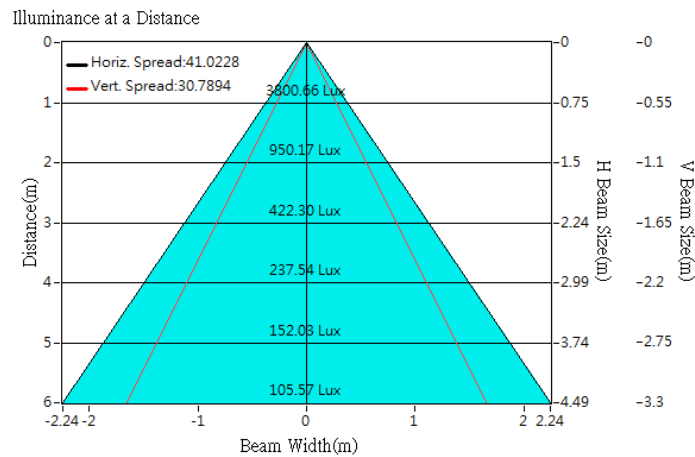



Optical Characteristics

| | | | |
|-------------------|------------------------------|------------------|-----------------------|
| Model Number | CKO-SA15-060027-4209 | | <p>"H" definition</p> |
| LED | CMT1407 | | |
| LES / LED Size | Φ 9.8 mm | | |
| FWHM (D50) | 29°x41° | | |
| Field Angle (D10) | 48°x82° | | |
| H (distance) | 3.65 mm | | |
| Dimension | Φ =60 mm, Thickness=26.85 mm | | |
| Luminous Flux | 849 lm | Measured @ 7.0 W | |
| Material | PC / UL94V2 | | |

cd/klm

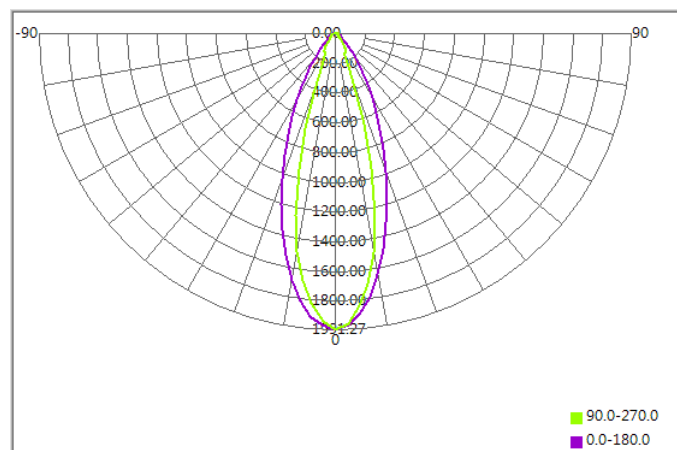

Illuminance At Distances

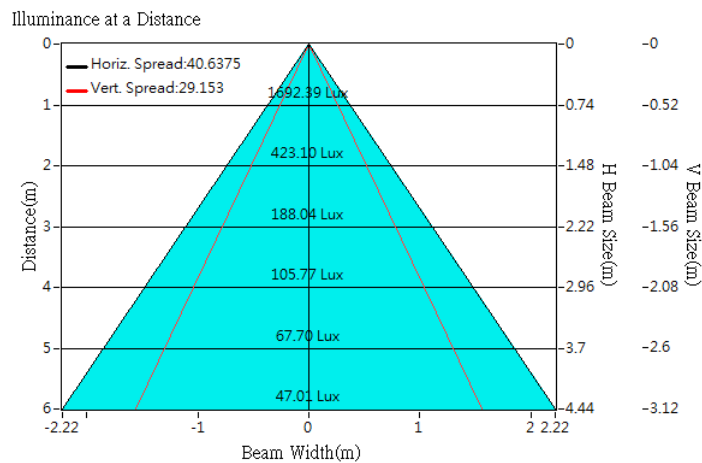



Optical Characteristics

| | | | |
|-------------------|------------------------------|-------------------|-----------------------|
| Model Number | CKO-SA15-060027-4209 | | <p>"H" definition</p> |
| LED | CMT1412 | | |
| LES / LED Size | Φ 9.8 mm | | |
| FWHM (D50) | 29°x41° | | |
| Field Angle (D10) | 45°x82° | | |
| H (distance) | 3.65 mm | | |
| Dimension | Φ =60 mm, Thickness=26.85 mm | | |
| Luminous Flux | 1452 lm | Measured @ 12.7 W | |
| Material | PC / UL94V2 | | |

cd/klm

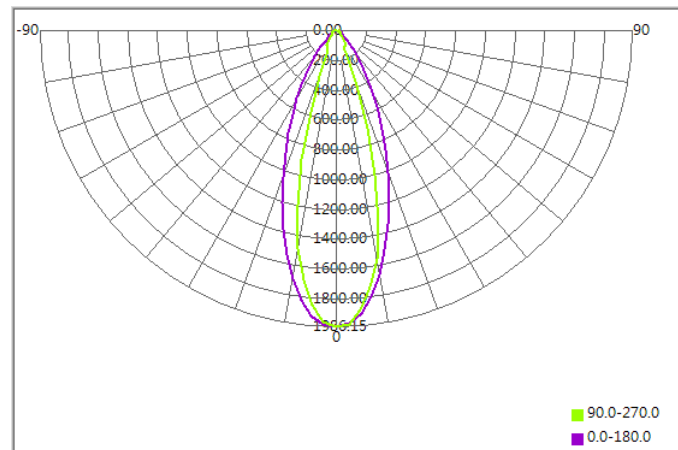

Illuminance At Distances

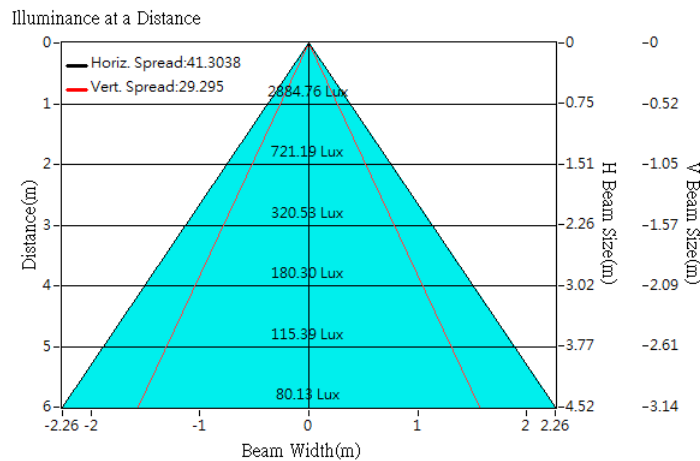



Optical Characteristics

| | | | |
|-------------------|------------------------------|-------------------|-----------------------|
| Model Number | CKO-SA15-060027-4209 | | <p>"H" definition</p> |
| LED | CMT1420 | | |
| LES / LED Size | Φ 9.8 mm | | |
| FWHM (D50) | 29°x41° | | |
| Field Angle (D10) | 48°x82° | | |
| H (distance) | 3.65 mm | | |
| Dimension | Φ =60 mm, Thickness=26.85 mm | | |
| Luminous Flux | 2177 lm | Measured @ 19.0 W | |
| Material | PC / UL94V2 | | |

cd/klm

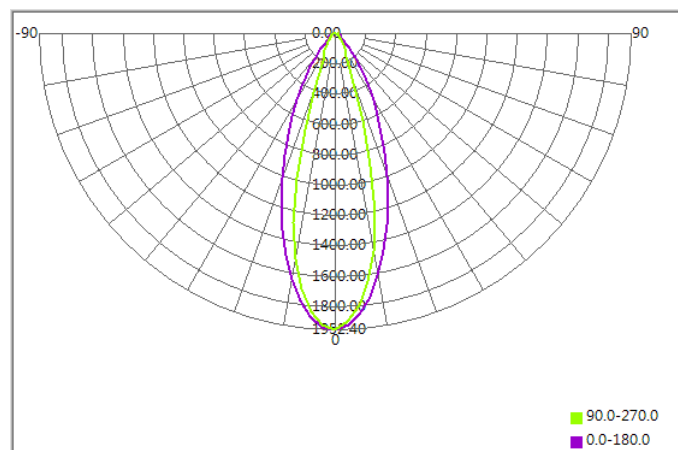

Illuminance At Distances

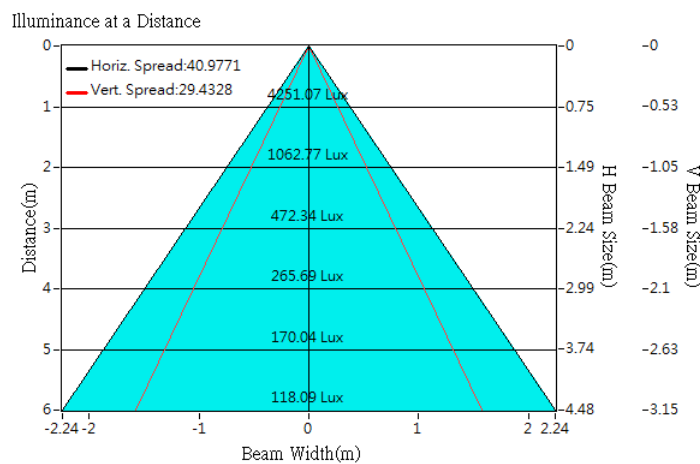



Optical Characteristics

| | | |
|-------------------|------------------------------|-----------------------|
| Model Number | CKO-SA15-060027-4209 | <p>"H" definition</p> |
| LED | CXA1816 | |
| LES / LED Size | Φ 12 mm | |
| FWHM (D50) | 34°x43° | |
| Field Angle (D10) | 54°x85° | |
| H (distance) | 3.65 mm | |
| Dimension | Φ =60 mm, Thickness=26.85 mm | |
| Luminous Flux | 1497 lm | |
| Material | PC / UL94V2 | |

cd/klm

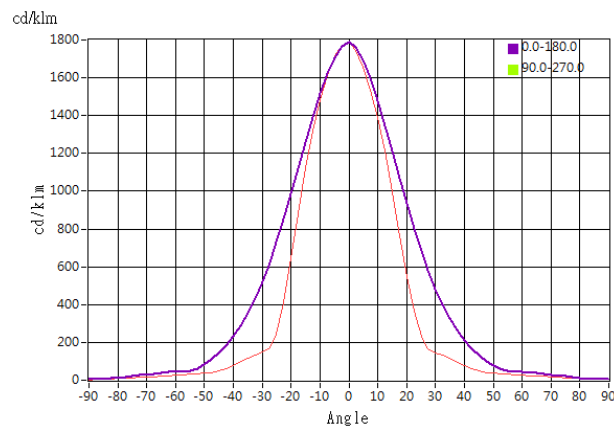

Illuminance At Distances

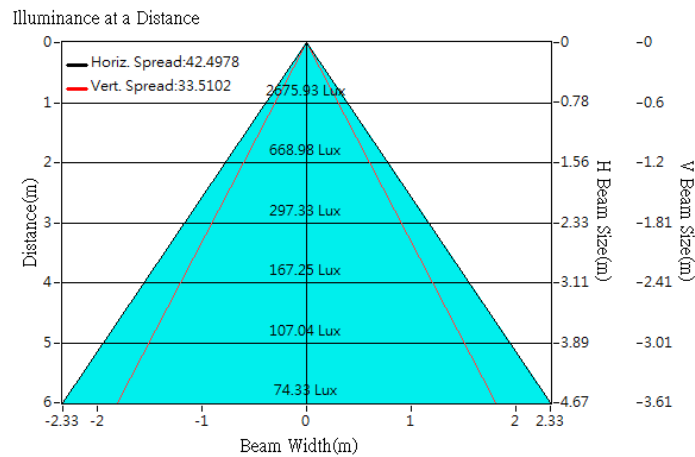



Optical Characteristics

| | | | |
|-------------------|------------------------------|-------------------|-----------------------|
| Model Number | CKO-SA15-060027-4209 | | <p>"H" definition</p> |
| LED | CXB1816 | | |
| LES / LED Size | Φ 12 mm | | |
| FWHM (D50) | 34°x42° | | |
| Field Angle (D10) | 54°x84° | | |
| H (distance) | 3.65 mm | | |
| Dimension | Φ =60 mm, Thickness=26.85 mm | | |
| Luminous Flux | 1688 lm | Measured @ 15.7 W | |
| Material | PC / UL94V2 | | |

cd/klm

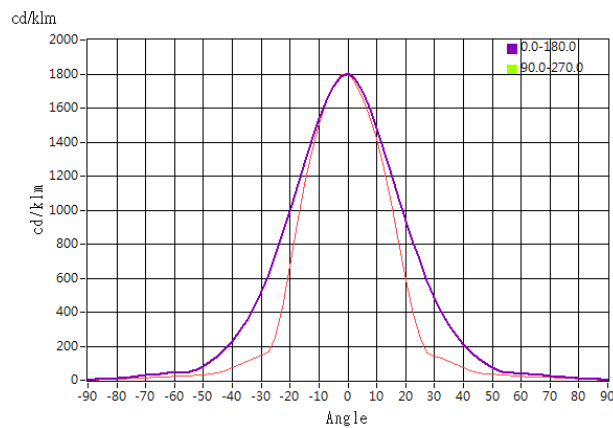

Illuminance At Distances

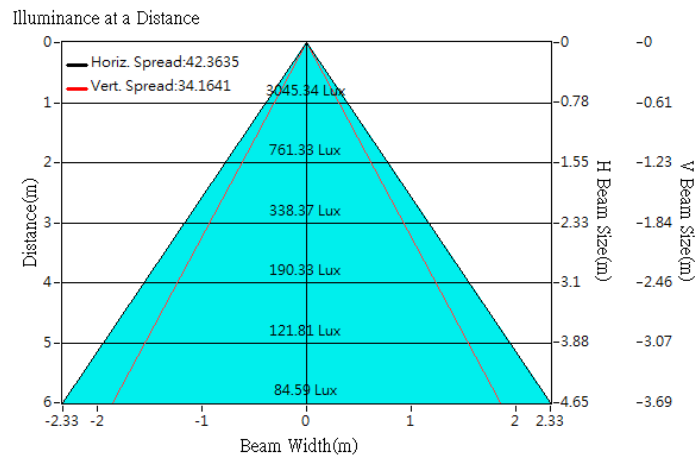



Optical Characteristics

| | | | |
|-------------------|------------------------------|-------------------|-----------------------|
| Model Number | CKO-SA15-060027-4209 | | <p>"H" definition</p> |
| LED | CXA1820 | | |
| LES / LED Size | Φ 12 mm | | |
| FWHM (D50) | 34°x42° | | |
| Field Angle (D10) | 55°x85° | | |
| H (distance) | 3.65 mm | | |
| Dimension | Φ =60 mm, Thickness=26.85 mm | | |
| Luminous Flux | 1821 lm | Measured @ 19.9 W | |
| Material | PC / UL94V2 | | |

cd/klm

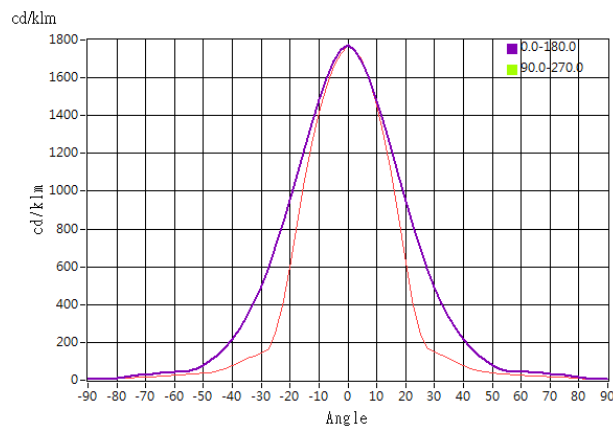

Illuminance At Distances

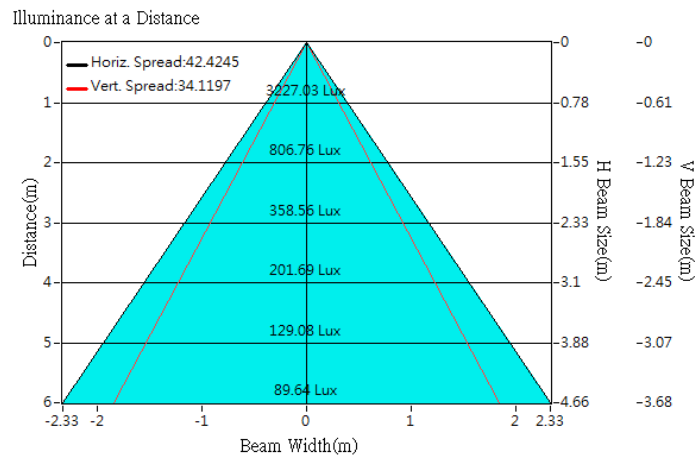



Optical Characteristics

| | | | |
|-------------------|------------------------------|-------------------|--|
| Model Number | CKO-SA15-060027-4209 | | <p>"H" definition</p> <p>LES CoB "H" mm (distance)</p> |
| LED | CXB1820 | | |
| LES / LED Size | Φ 12 mm | | |
| FWHM (D50) | 35°x43° | | |
| Field Angle (D10) | 54°x85° | | |
| H (distance) | 3.65 mm | | |
| Dimension | Φ =60 mm, Thickness=26.85 mm | | |
| Luminous Flux | 2154 lm | Measured @ 19.5 W | |
| Material | PC / UL94V2 | | |

cd/klm

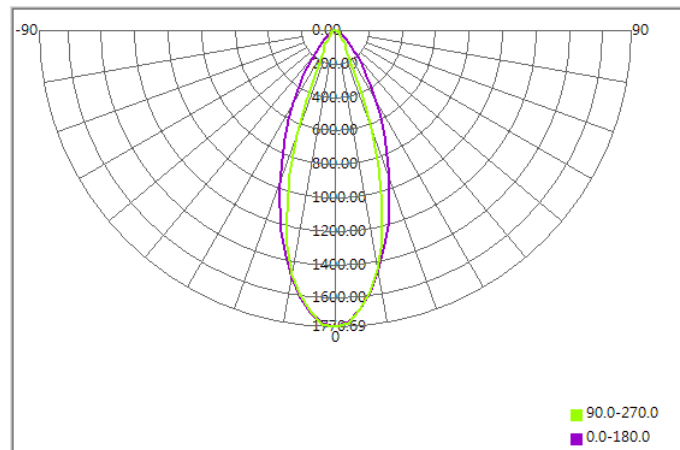

Illuminance At Distances

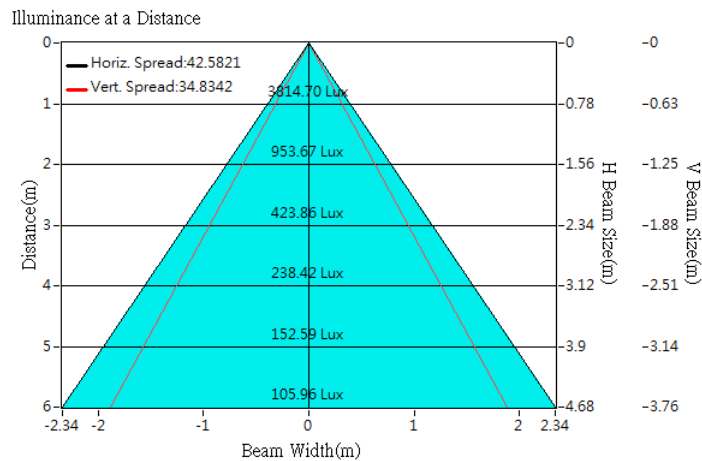



Optical Characteristics

| | | |
|-------------------|------------------------------|-----------------------|
| Model Number | CKO-SA15-060027-4209 | <p>"H" definition</p> |
| LED | CMA1825 | |
| LES / LED Size | Φ 12 mm | |
| FWHM (D50) | 35°x43° | |
| Field Angle (D10) | 59°x86° | |
| H (distance) | 3.65 mm | |
| Dimension | Φ =60 mm, Thickness=26.85 mm | |
| Luminous Flux | 2735 lm | |
| Material | PC / UL94V2 | |

cd/klm

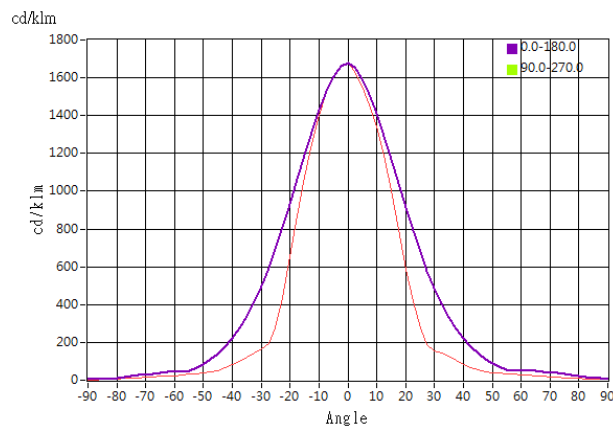

Illuminance At Distances

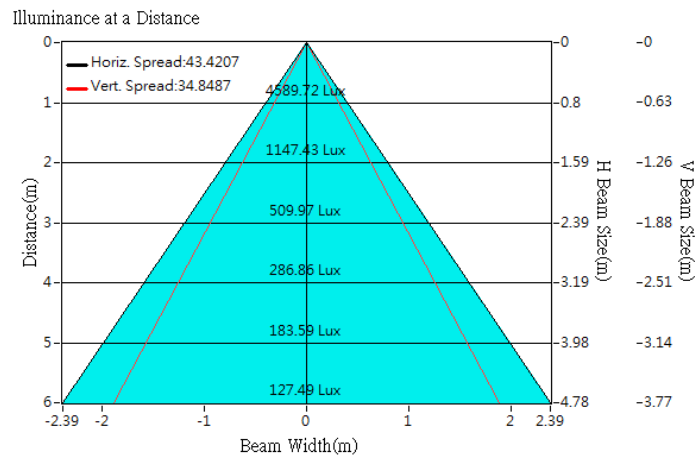



Optical Characteristics

| | | | |
|-------------------|------------------------------|-------------------|-----------------------|
| Model Number | CKO-SA15-060027-4209 | | <p>"H" definition</p> |
| LED | CXA1830 | | |
| LES / LED Size | Φ 14 mm | | |
| FWHM (D50) | 35°x44° | | |
| Field Angle (D10) | 62°x87° | | |
| H (distance) | 3.65 mm | | |
| Dimension | Φ =60 mm, Thickness=26.85 mm | | |
| Luminous Flux | 2470 lm | Measured @ 29.1 W | |
| Material | PC / UL94V2 | | |

cd/klm

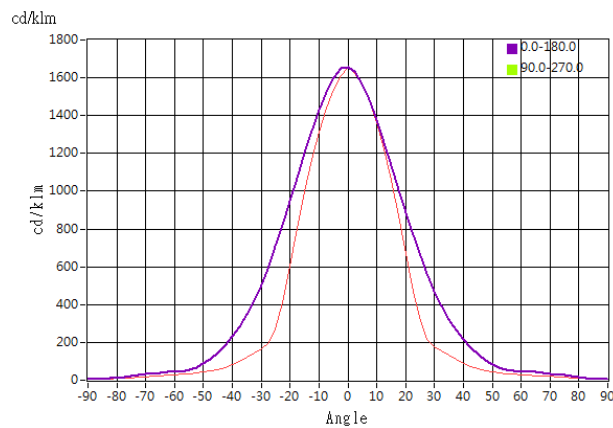

Illuminance At Distances

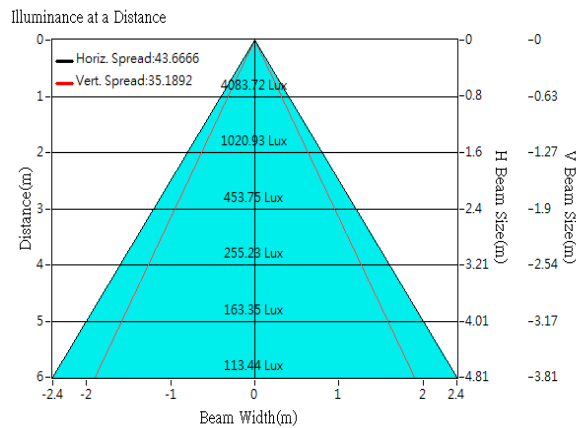

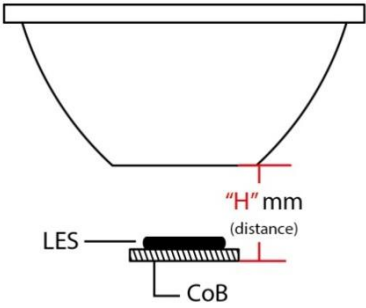

Optical Characteristics

| | | | |
|-------------------|------------------------------|-------------------|--|
| Model Number | CKO-SA15-060027-4209 | | <p>"H" definition</p>  |
| LED | CXB1830 | | |
| LES / LED Size | Φ 14 mm | | |
| FWHM (D50) | 37°x44° | | |
| Field Angle (D10) | 64°x87° | | |
| H (distance) | 3.65 mm | | |
| Dimension | Φ =60 mm, Thickness=26.85 mm | | |
| Luminous Flux | 3039 lm | Measured @ 28.2 W | |
| Material | PC / UL94V2 | | |

cd/klm

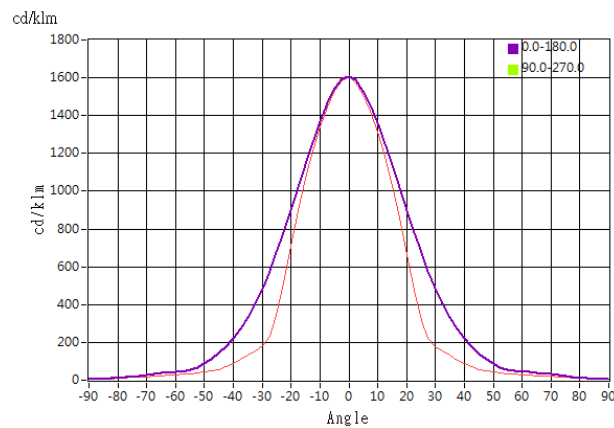

Illuminance At Distances

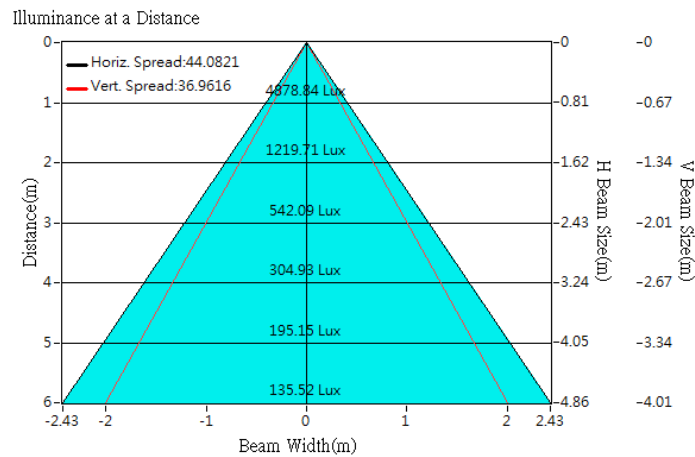



Optical Characteristics

| | | | |
|-------------------|------------------------------|-------------------|-----------------------|
| Model Number | CKO-SA15-060027-4209 | | <p>"H" definition</p> |
| LED | CMA1840 | | |
| LES / LED Size | Φ 14 mm | | |
| FWHM (D50) | 38°x44° | | |
| Field Angle (D10) | 65°x88° | | |
| H (distance) | 3.65 mm | | |
| Dimension | Φ =60 mm, Thickness=26.85 mm | | |
| Luminous Flux | 4196 lm | Measured @ 38.8 W | |
| Material | PC / UL94V2 | | |

cd/klm

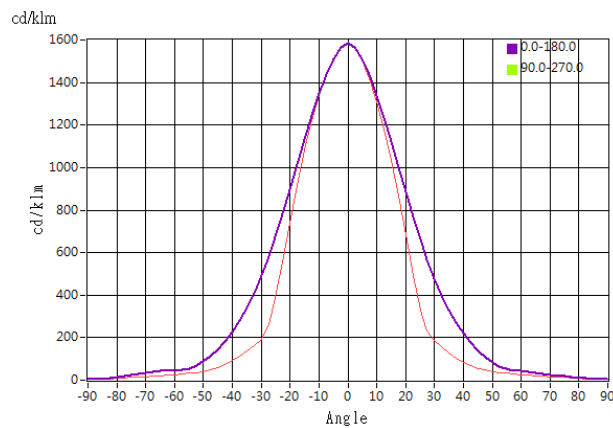

Illuminance At Distances

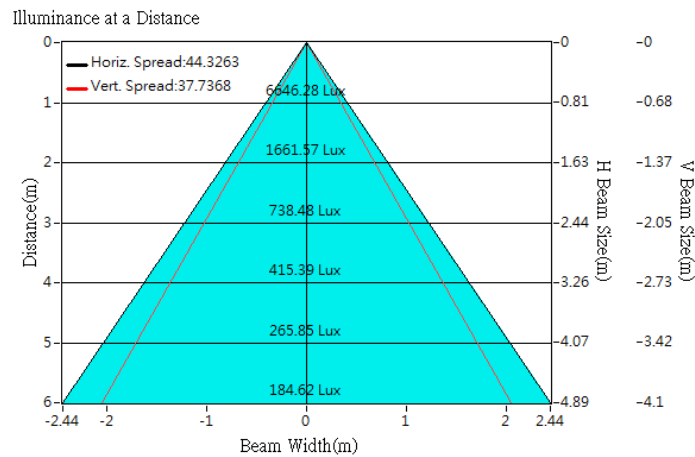



Optical Characteristics

| | | | |
|-------------------|------------------------------|-------------------|-----------------------|
| Model Number | CKO-SA15-060027-4209 | | <p>"H" definition</p> |
| LED | CMT1922 | | |
| LES / LED Size | Φ 14.5 mm | | |
| FWHM (D50) | 37°x45° | | |
| Field Angle (D10) | 69°x89° | | |
| H (distance) | 3.65 mm | | |
| Dimension | Φ =60 mm, Thickness=26.85 mm | | |
| Luminous Flux | 2350 lm | Measured @ 21.7 W | |
| Material | PC / UL94V2 | | |

cd/klm

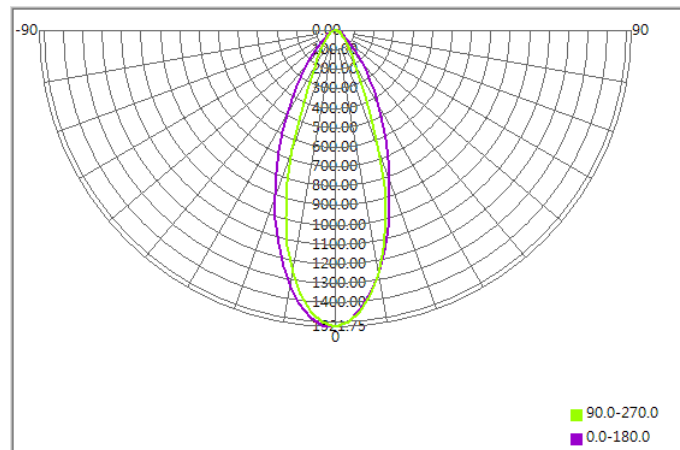

Illuminance At Distances

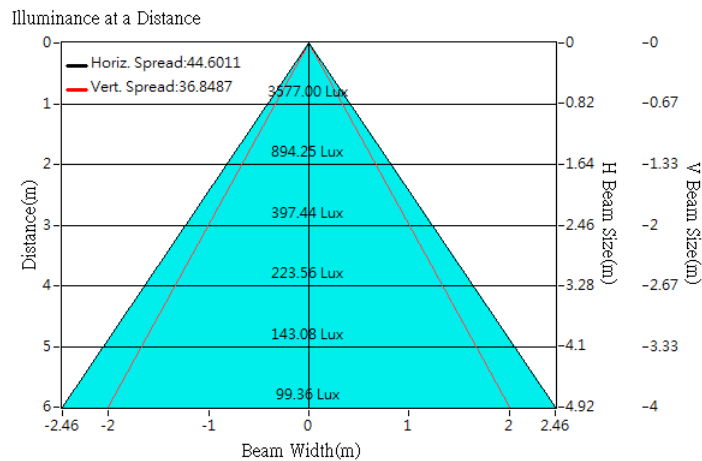



Optical Characteristics

| | | | |
|-------------------|------------------------------|-------------------|--|
| Model Number | CKO-SA15-060027-4209 | | <p>"H" definition</p> <p>LES CoB</p> |
| LED | CMT1925 | | |
| LES / LED Size | Φ 14.5 mm | | |
| FWHM (D50) | 37°x45° | | |
| Field Angle (D10) | 64°x88° | | |
| H (distance) | 3.65 mm | | |
| Dimension | Φ =60 mm, Thickness=26.85 mm | | |
| Luminous Flux | 2781 lm | Measured @ 25.3 W | |
| Material | PC / UL94V2 | | |

cd/klm

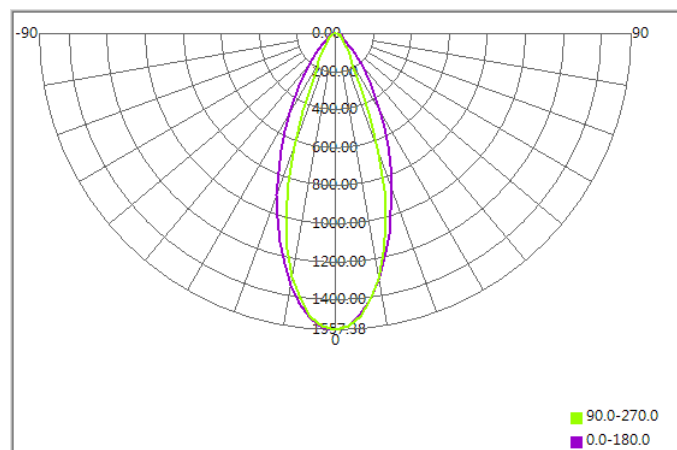

Illuminance At Distances

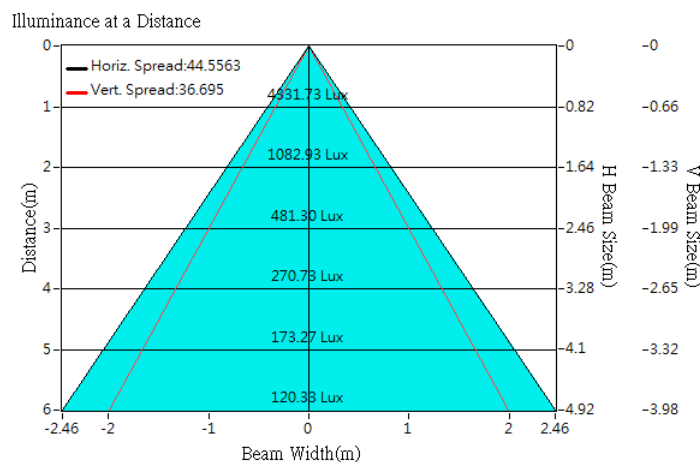



Optical Characteristics

| | | | |
|-------------------|------------------------------|-------------------|-----------------------|
| Model Number | CKO-SA15-060027-4209 | | <p>"H" definition</p> |
| LED | CMT1930 | | |
| LES / LED Size | Φ 14.5 mm | | |
| FWHM (D50) | 37°x45° | | |
| Field Angle (D10) | 56°x85° | | |
| H (distance) | 3.65 mm | | |
| Dimension | Φ =60 mm, Thickness=26.85 mm | | |
| Luminous Flux | 3138 lm | Measured @ 29.1 W | |
| Material | PC / UL94V2 | | |

cd/klm

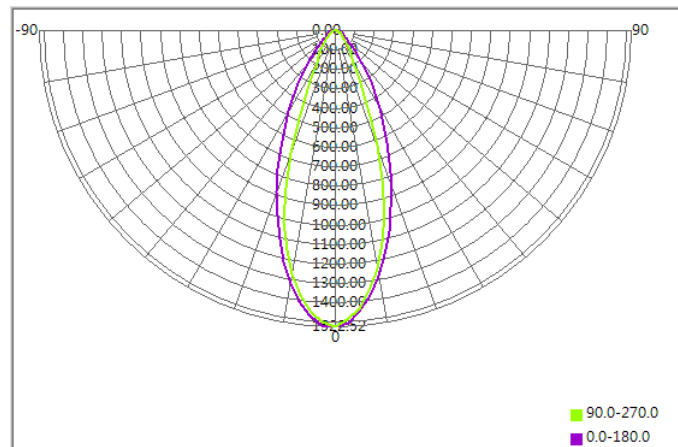

Illuminance At Distances

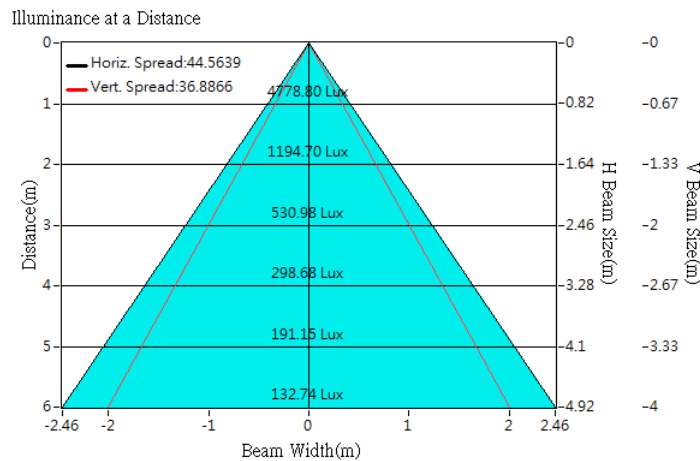



Optical Characteristics

| | | | |
|-------------------|------------------------------|-------------------|-----------------------|
| Model Number | CKO-SA15-060027-4209 | | <p>"H" definition</p> |
| LED | CMT1945 | | |
| LES / LED Size | Φ 14.5 mm | | |
| FWHM (D50) | 37°x45° | | |
| Field Angle (D10) | 67°x89° | | |
| H (distance) | 3.65 mm | | |
| Dimension | Φ =60 mm, Thickness=26.85 mm | | |
| Luminous Flux | 4472 lm | Measured @ 43.9 W | |
| Material | PC / UL94V2 | | |

cd/klm

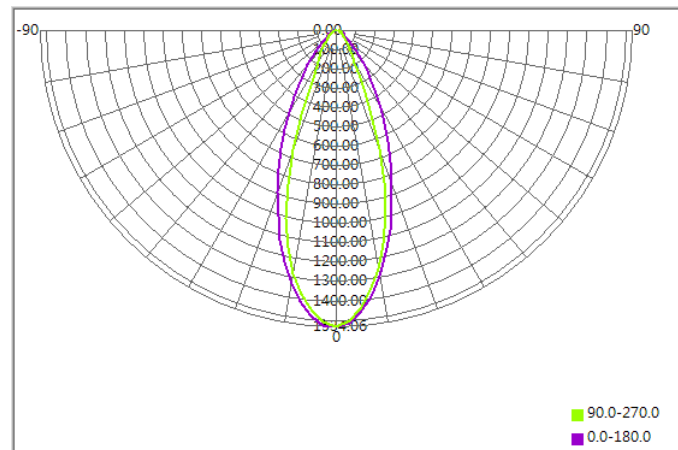

Illuminance At Distances

